

Reporte de actividades

Mario Rodríguez Cahuantzi

29 de Septiembre de 2012

NO BEAM RUNS
(DEDICATED COSMIC RUNS)

Purity = No. of AMU triggers with at least one TPC track / No. of AMU triggers

Purity ACORDE trigger for 2010

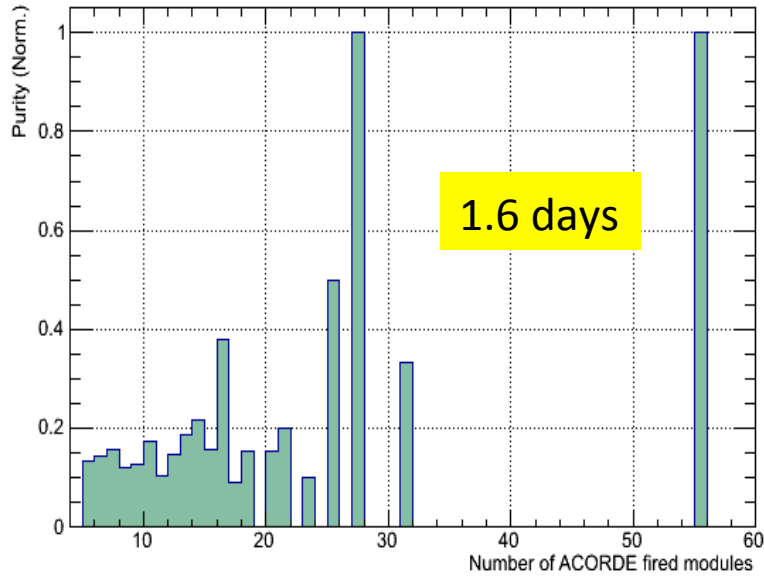

Purity ACORDE trigger 2011

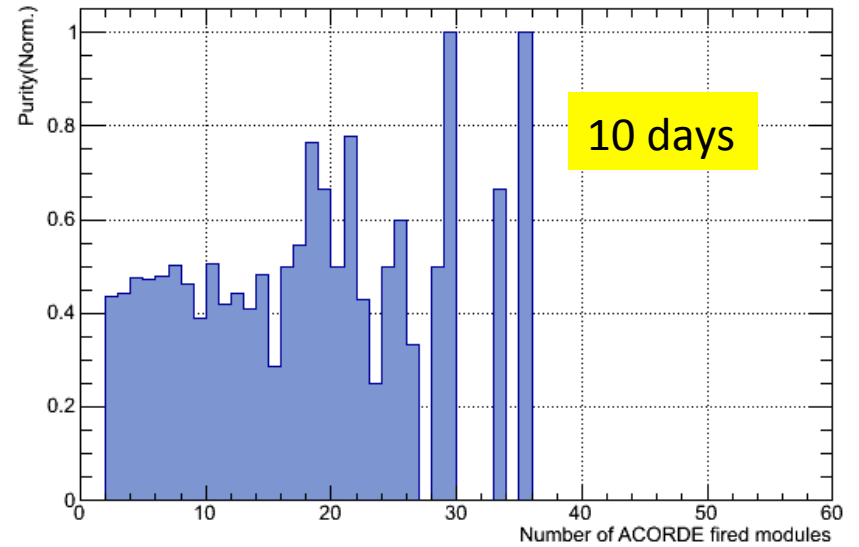

Purity of ACORDE trigger before TS (LHC12a,b,c)

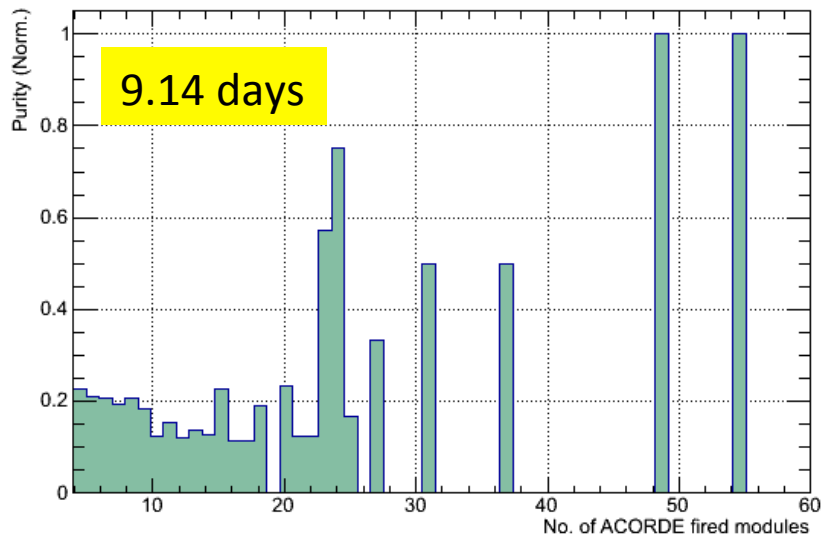

Purity of ACORDE trigger after TS (LHC12d,f)

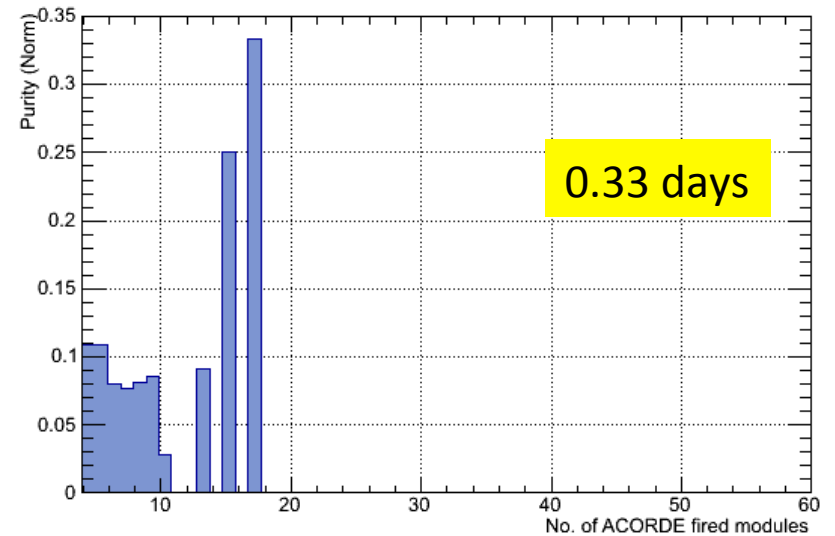

Purity = No. of AMU+TOF triggers with at least one TPC track / No. of AMU+TOF triggers

ACORDE-TOF coincidence triggers

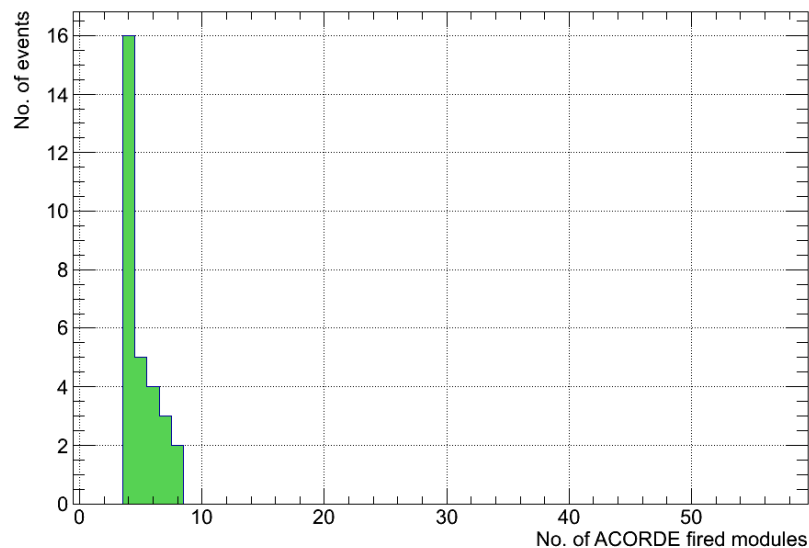

PURITY OF ACORDE+TOF TRIGGER: ~ 96 %

ACORDE-TOF coincidence triggers (ntracks>0)

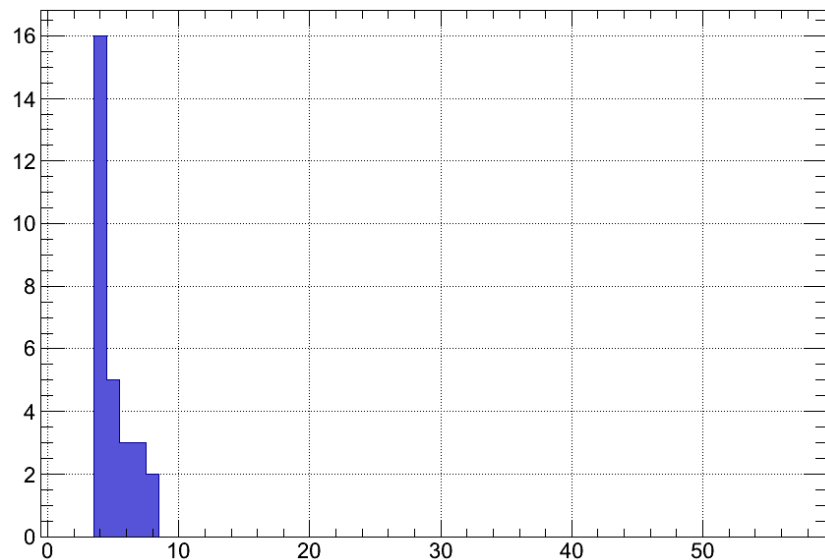

2012 DATA (NO BEAM RUNS)

ACORDE Fired modules multiplicity distribution (LHC12a,b,c)

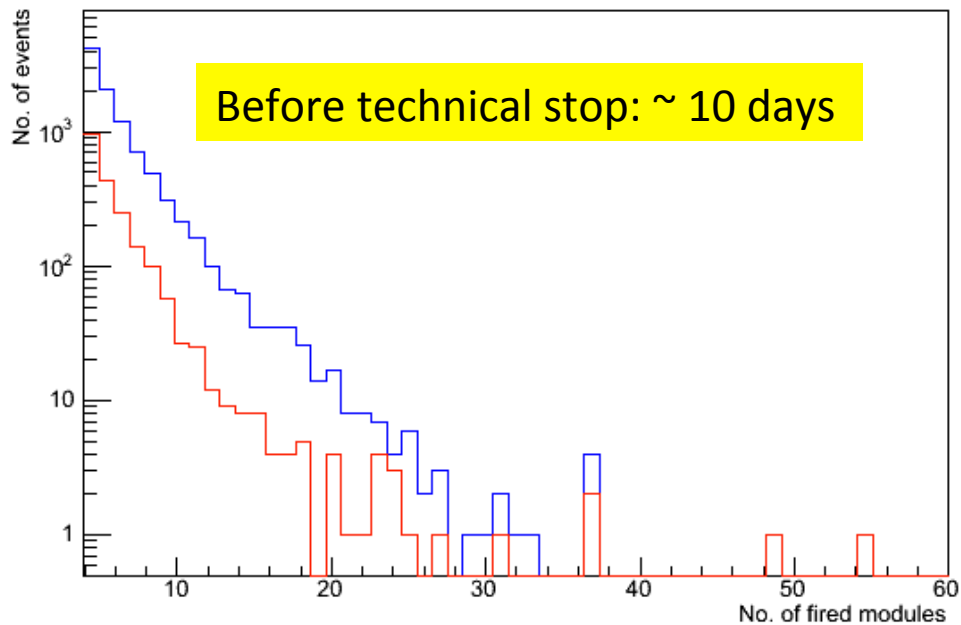

Blue line → All events
Red line → Events with TPC tracks > 0

ACORDE Fired modules multiplicity distribution (LHC12d,f)

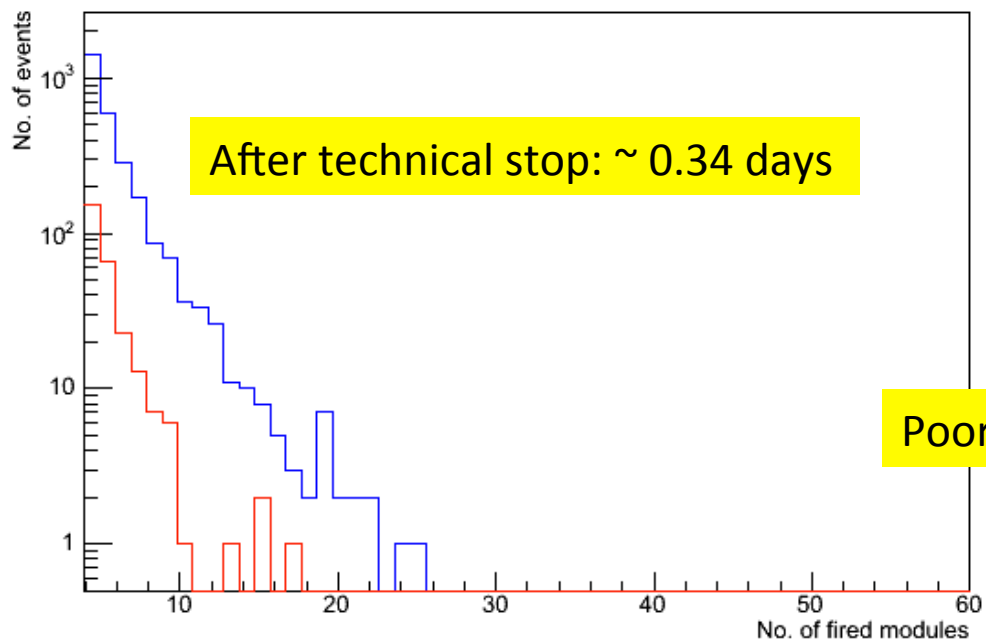

2012 DATA (NO BEAM RUNS)

LHC12d (no beam runs)

No. of muons (ALL triggers)

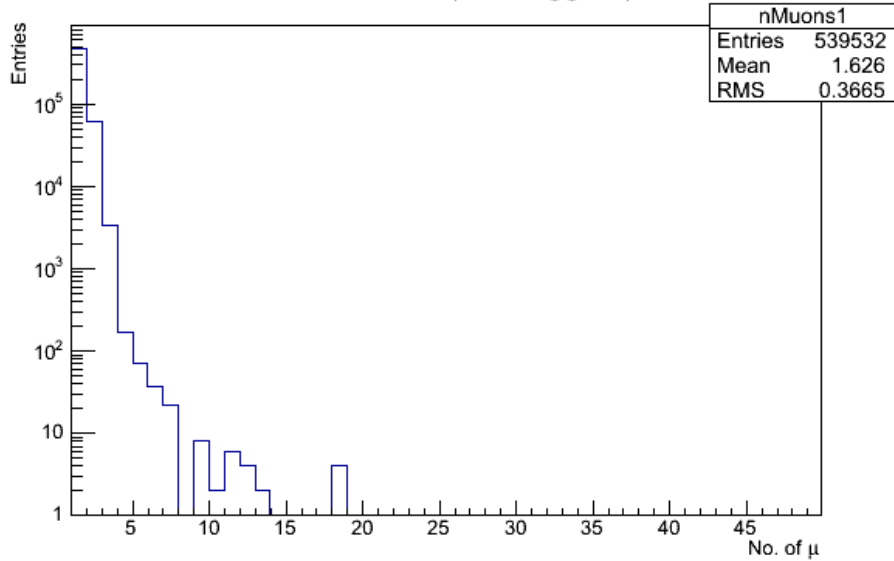

No. of muons (TRD)

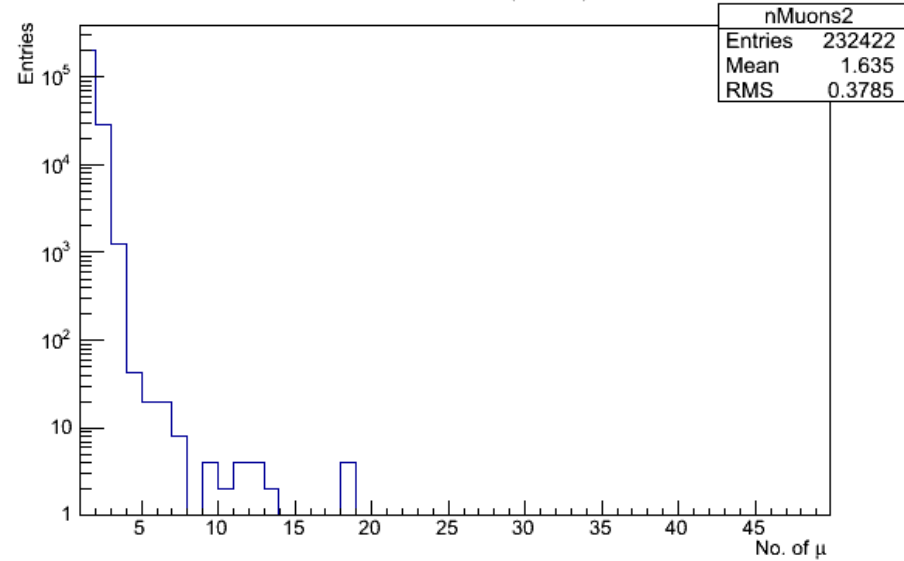

No. of muons (OB0)

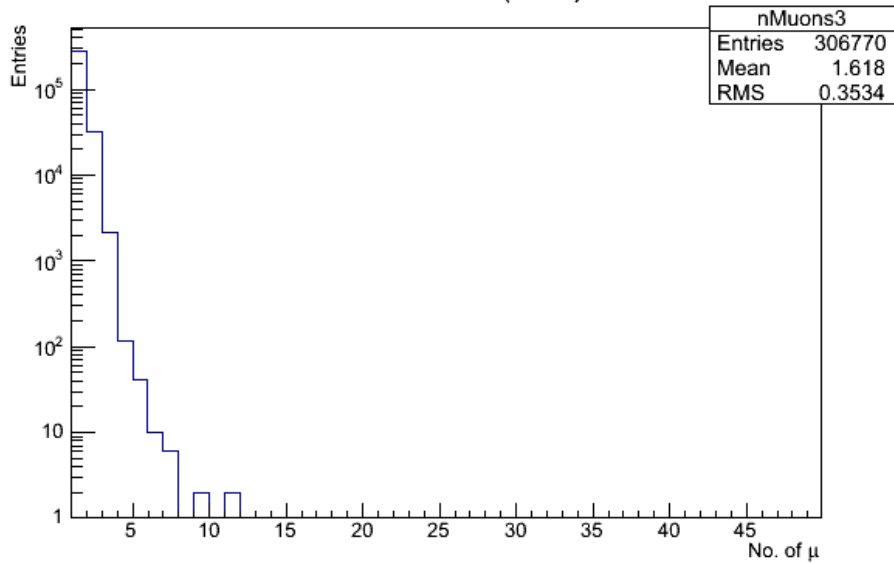

No. of muons (AMU)

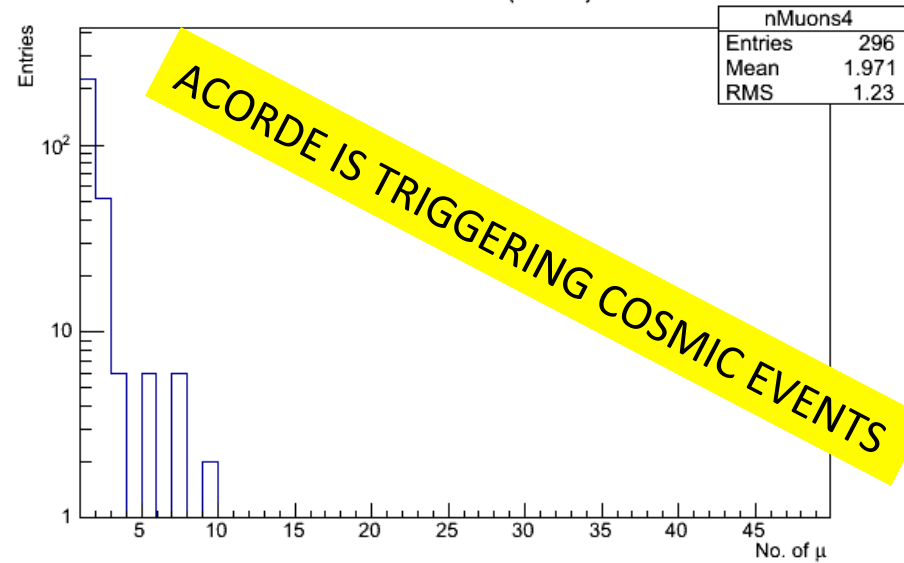

ACORDE IS TRIGGERING COSMIC EVENTS

LHC12f (no beam runs)

No. of muons (ALL triggers)

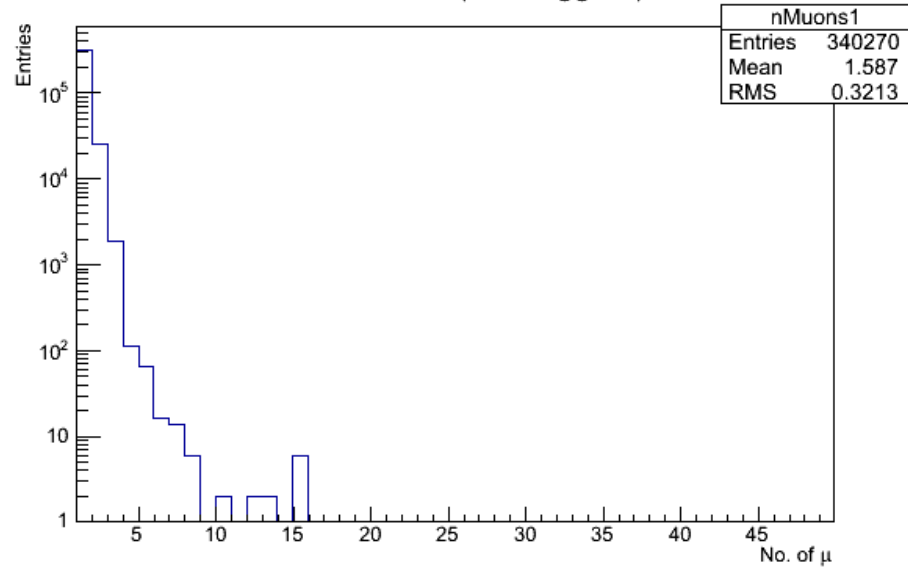

No. of muons (TRD)

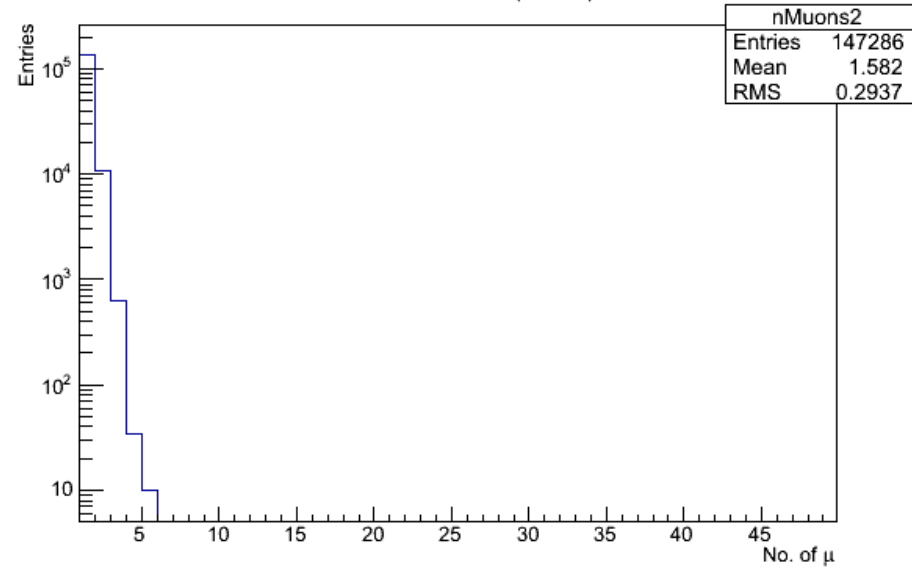

No. of muons (OB0)

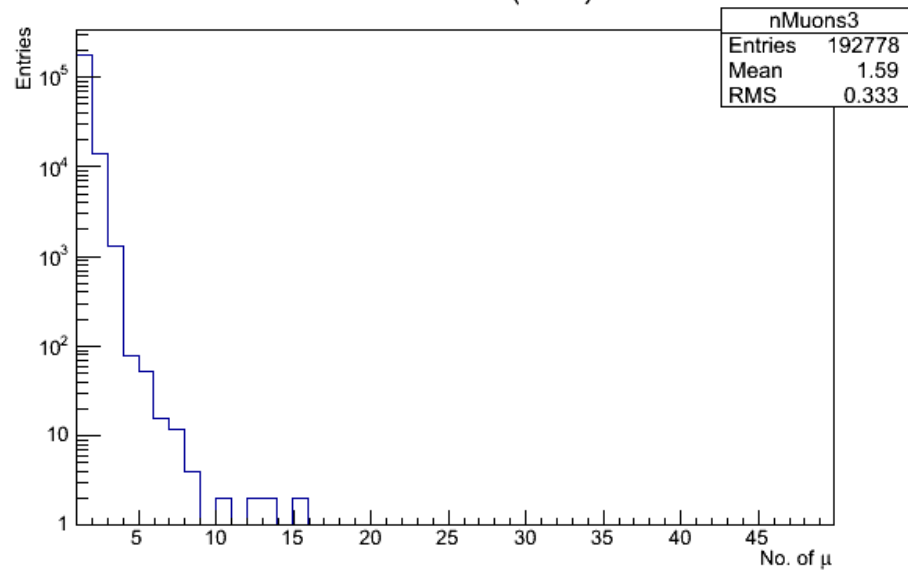

No. of muons (AMU)

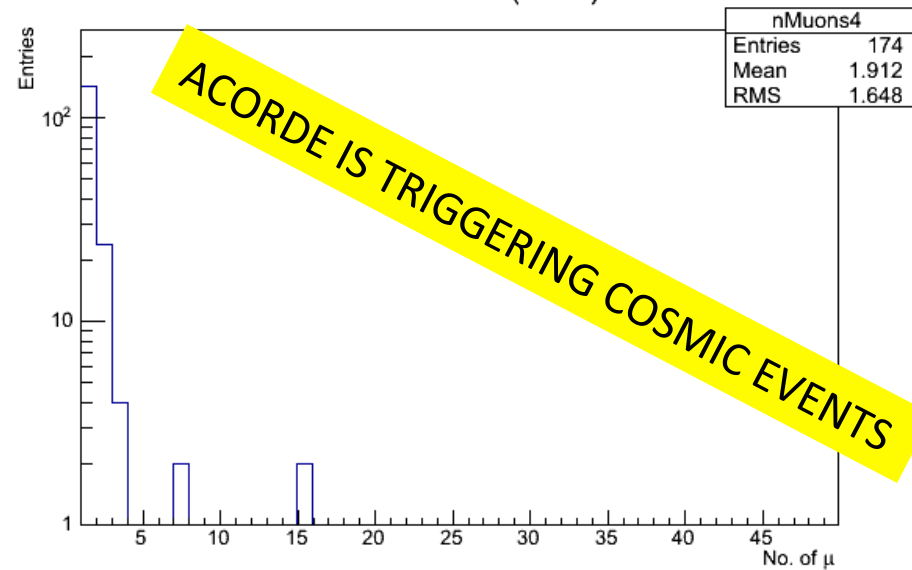

PP BEAM RUNS

LHC12b pp runs

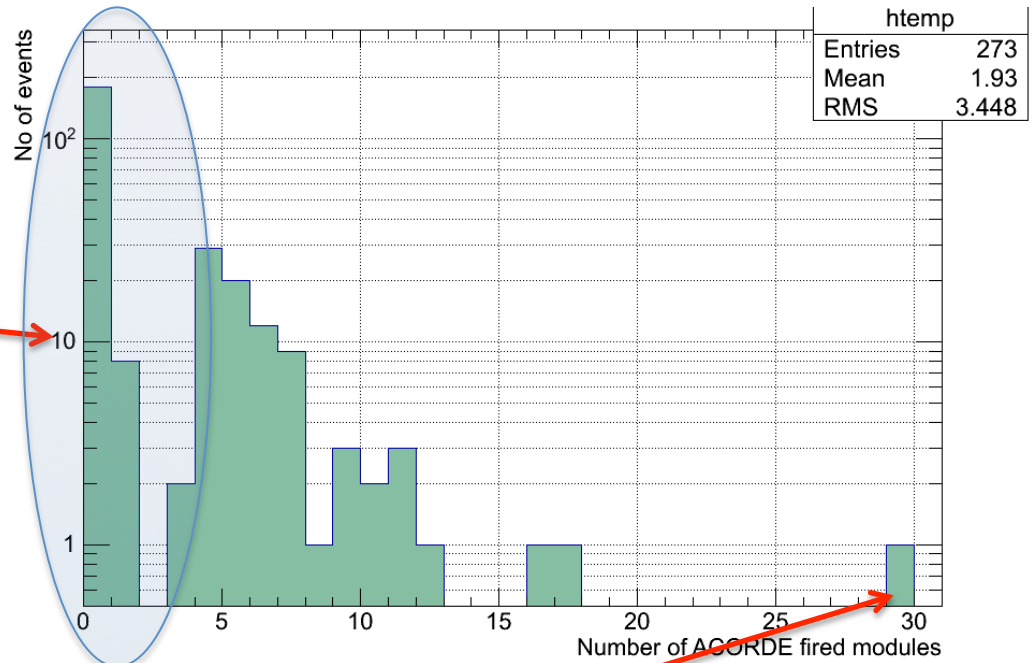

Not good triggers

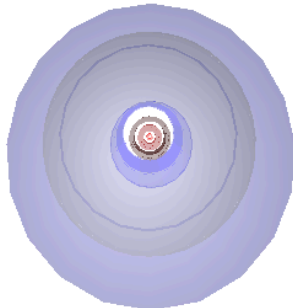
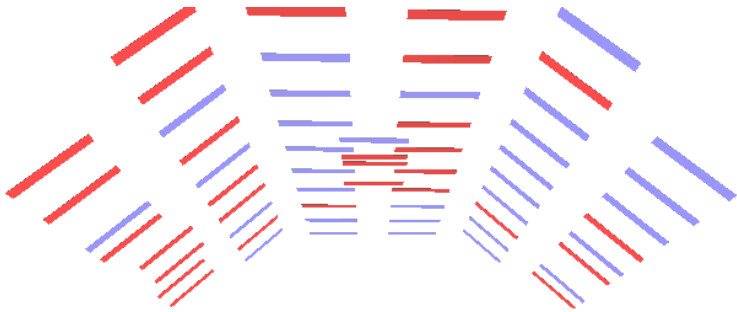

RUN: 184968 (~ 6 hours)

LHC12d pp runs (AMU triggers)

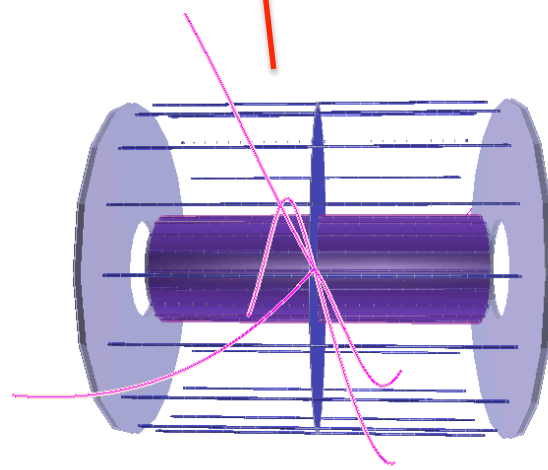
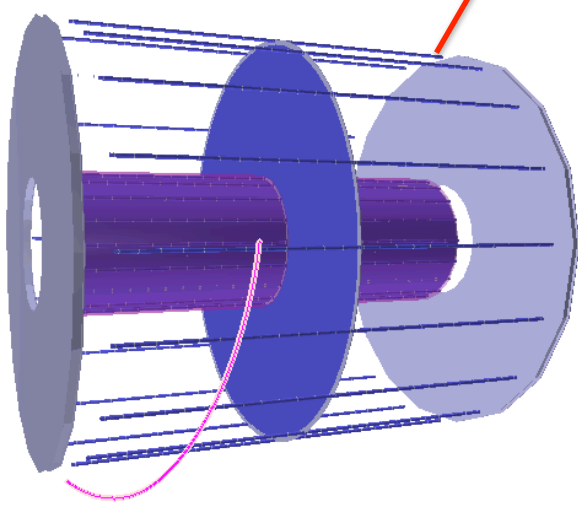
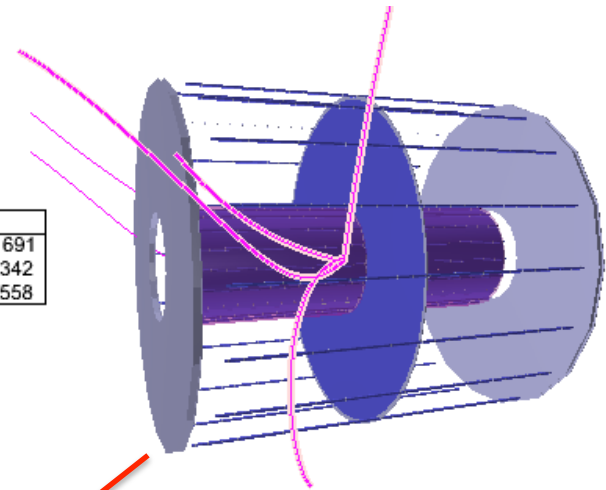
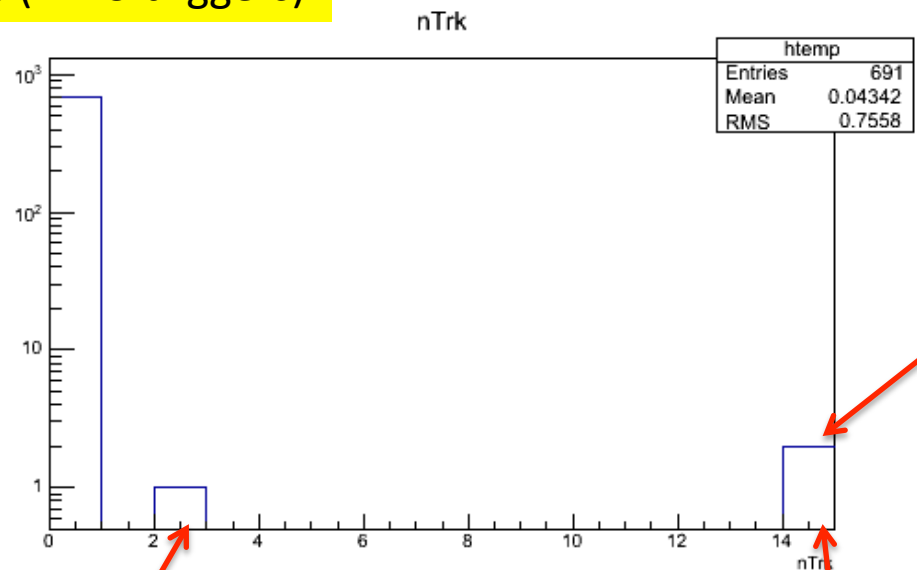

Comentarios finales

- Se hizo material para la reunión del PWG-UD (Lunes 24/Sept/2012) y el trigger meeting (Viernes 28/Sept/2012)
- Hacer el análisis en toda la muestra de los periodos LHC12d, LHC12e & LHC12f
- Preparar material para la reunión del PWG-UD (Lunes 1/Oct/2012)?