

Effective Field Theories in Flavor Physics and as Indirect Probes Beyond the Standard Model

Matthias Neubert

Mainz Institute for Theoretical Physics
Johannes Gutenberg University

XV. Mexican School on Particles and Fields

Benemérita Universidad Autónoma de Puebla
Puebla, Mexico, 6-15 September 2012

 **PRISMA Cluster of Excellence**
Precision Physics, Fundamental Interactions and Structure of Matter

 **ERC Advanced Grant (EFT4LHC)**
An Effective Field Theory Assault on the
Zeptometer Scale: Exploring the Origins of
Flavor and Electroweak Symmetry Breaking



JOHANNES GUTENBERG
UNIVERSITÄT MAINZ



Quark flavor physics

Lecture I: Concepts of Quark Flavor Physics

- Introduction and motivation
- Yukawa couplings, CKM matrix, unitarity triangle
- Neutral meson mixing, some UT determinations

Lecture II: Indirect Searches for New Physics

- CP violation in the interference of mixing and decay
- Effective weak interactions
- Testing the Standard Model with rare FCNC processes

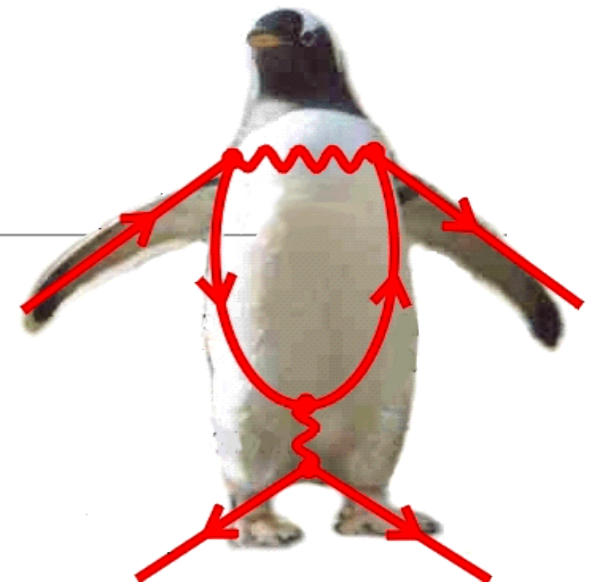

Effective field theory

Lecture III: Concepts of Effective Field Theory

- Basic ideas, Wilsonian effective action
- Scale separation, integrating out high-energy modes, low-energy effective Lagrangian, dimensional analysis
- Modern view of QFTs and general principles

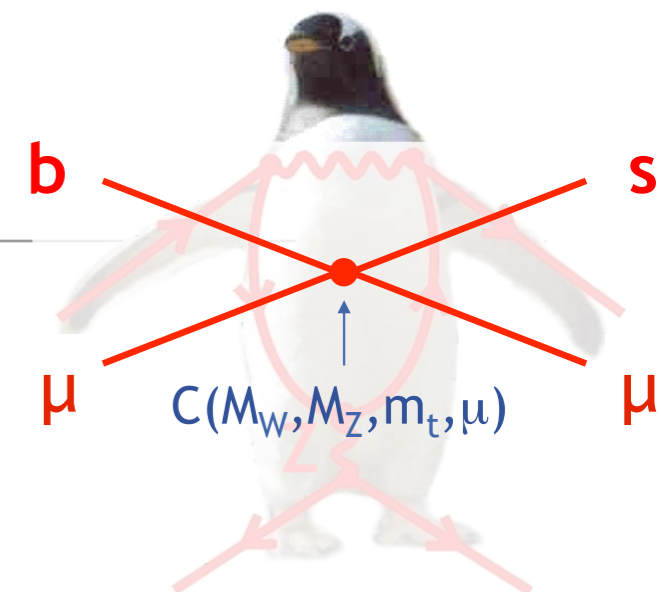

Lecture IV: Applications of Effective Field Theory

- The Standard Model as an effective field theory
- Several examples of applications beyond the Standard Model
- Interesting insights

Remembering Puebla ...

Heavy Quark Physics

Cracking the Standard Model?

Matthias Neubert – Cornell University

CTEQ Summer School 2005

Puebla – Mexico

May 2005

Searching for the unknown

- ✱ So far, all measurements in the flavor sector are in agreement with the SM
- ✱ However, there are tantalizing hints of New Physics effects in some **rare, penguin-dominated decays**
- ✱ Not in contradiction with anything we know from other processes (e.g., $B \rightarrow X_s \gamma$)
- ✱ Experimental situation stabilizes, and theory is under good control

★ Experimental situation: (after LP 03)

- $S(\phi K_S) = +0.45 \pm 0.43 \pm 0.07$ BaBar
 - $S(\phi K_S) = -0.96 \pm 0.50 \pm 0.10$ Belle
- } -0.15 ± 0.33

$S(\phi K_S) - S(J/\psi K_S) = -0.88 \pm 0.33 (2.7\sigma)$

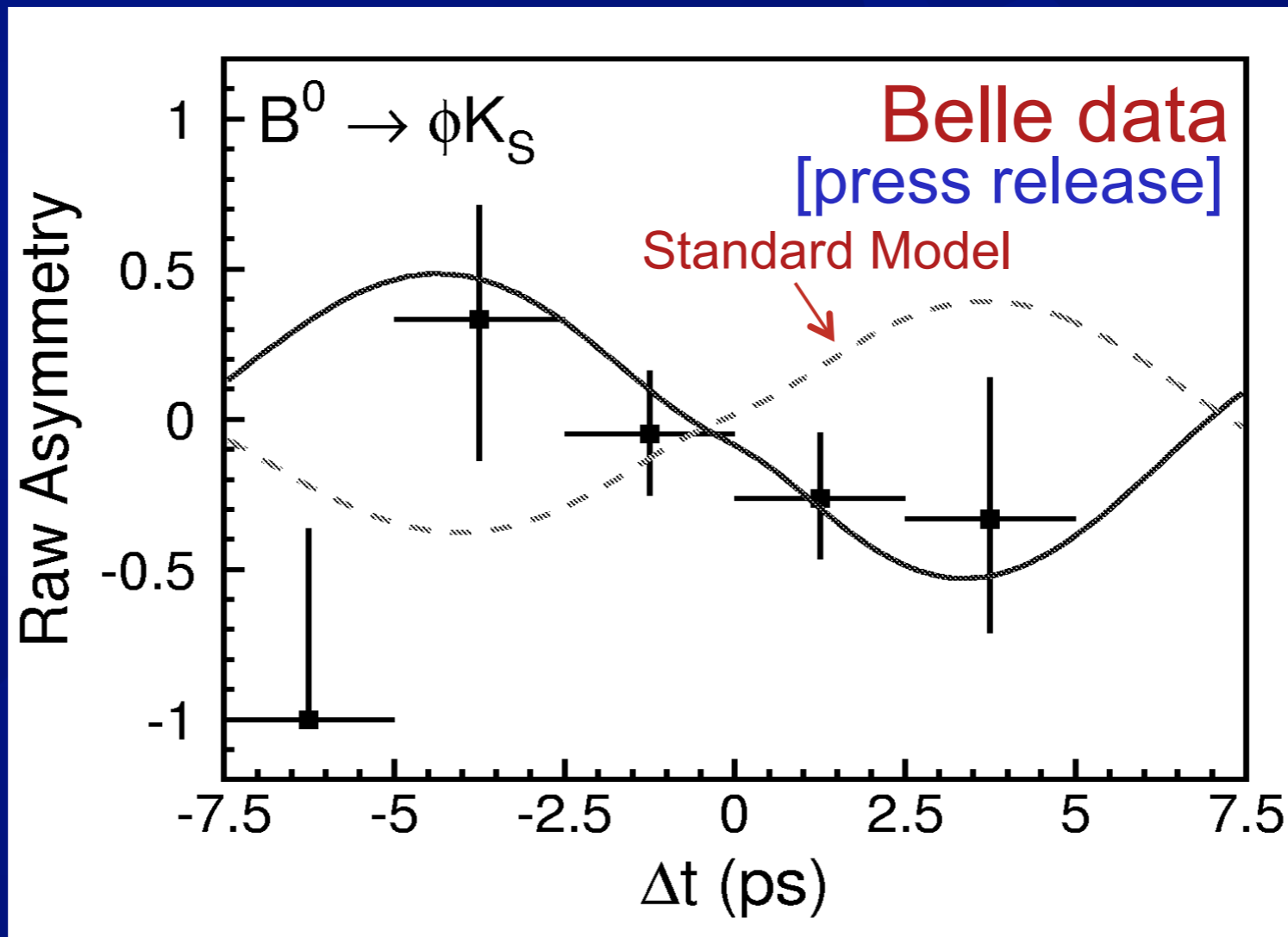

Deviation is 3.8σ !!!

7 reasons for excitement!

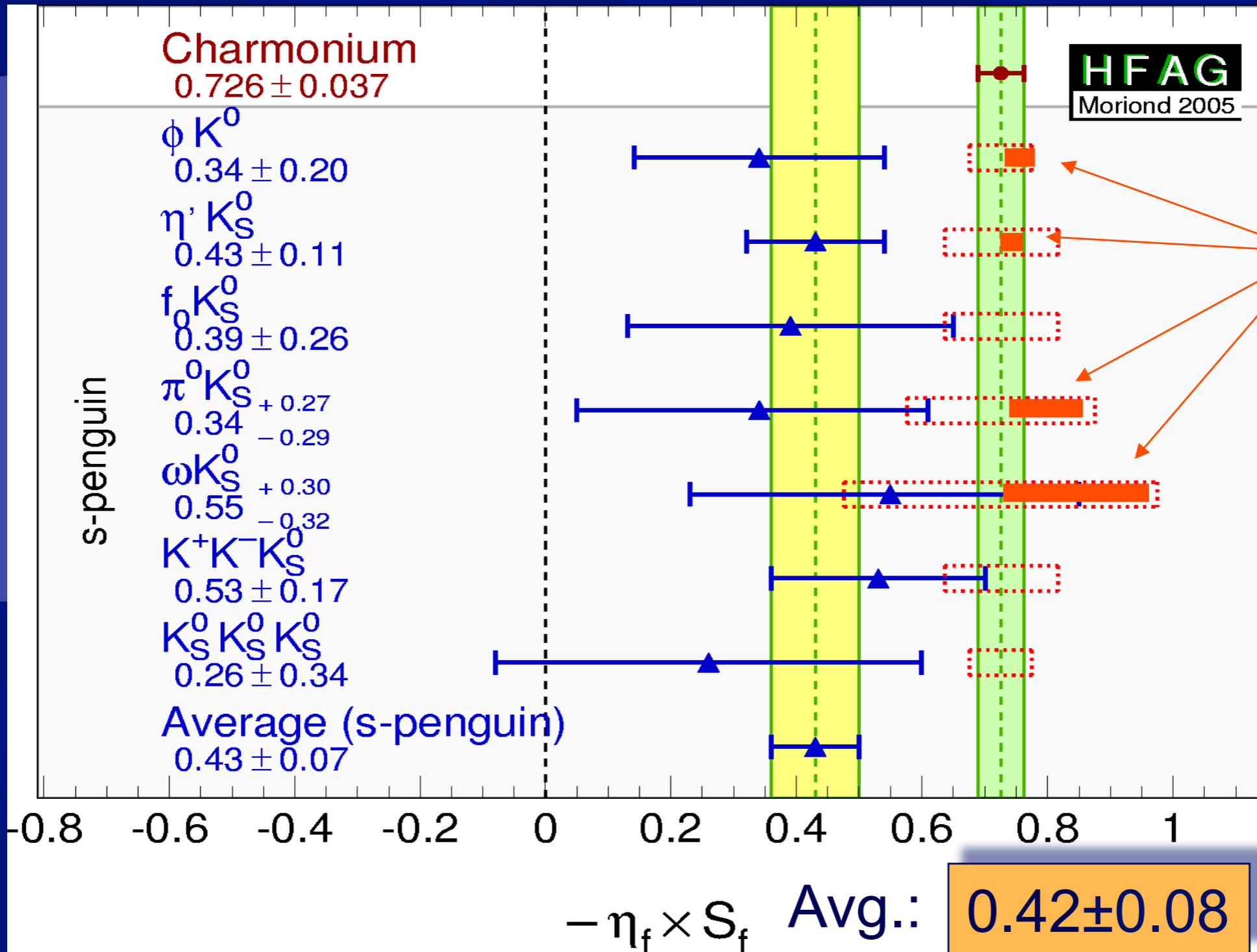

Current status (Winter 2012)

$$\sin(2\beta^{\text{eff}}) \equiv \sin(2\phi_1^{\text{eff}})$$

HFAG
Moriond 2012
PRELIMINARY

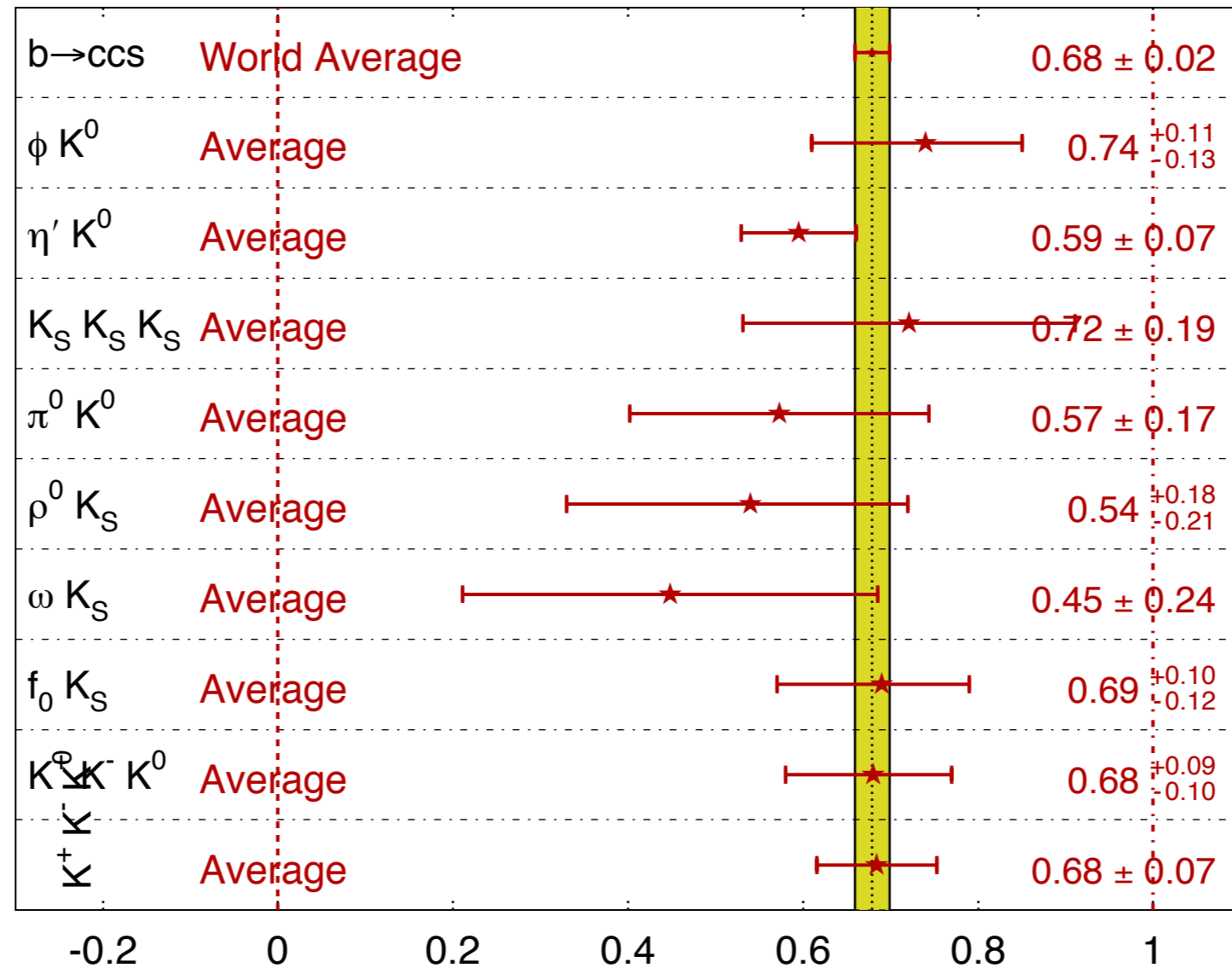

... effect has evaporated in all modes !

The Standard Model still stands, but ...

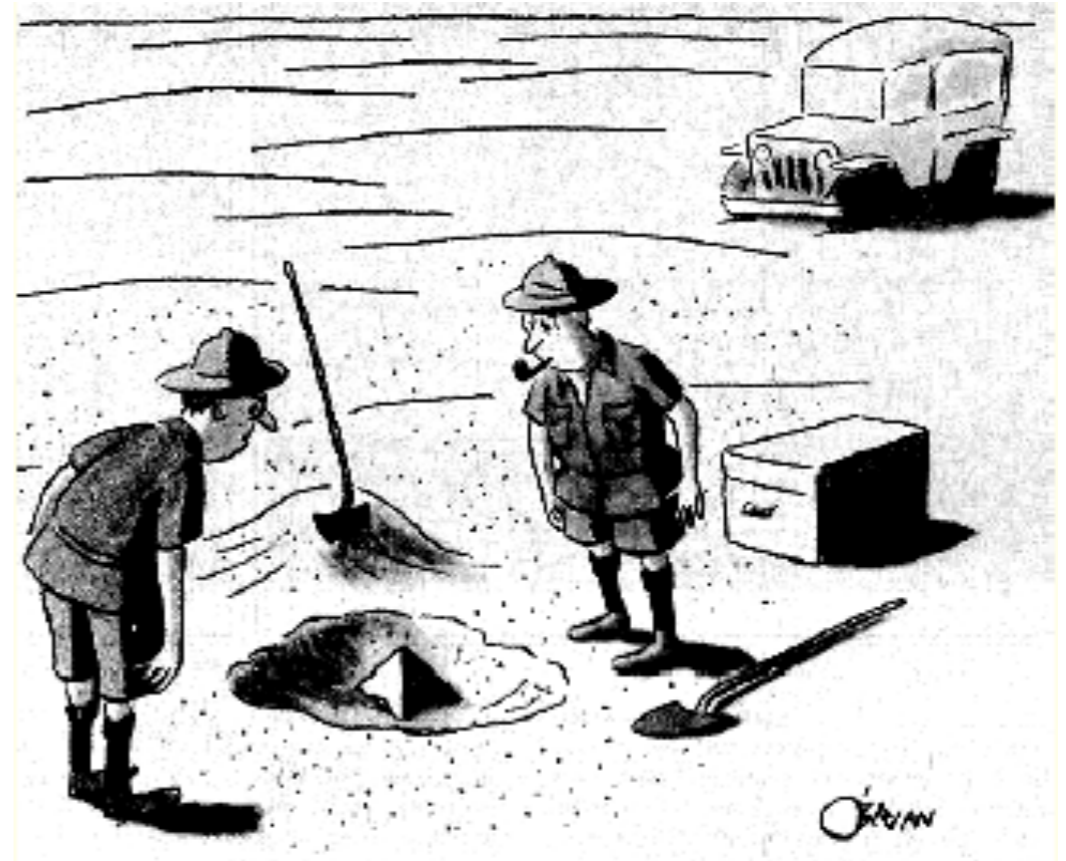
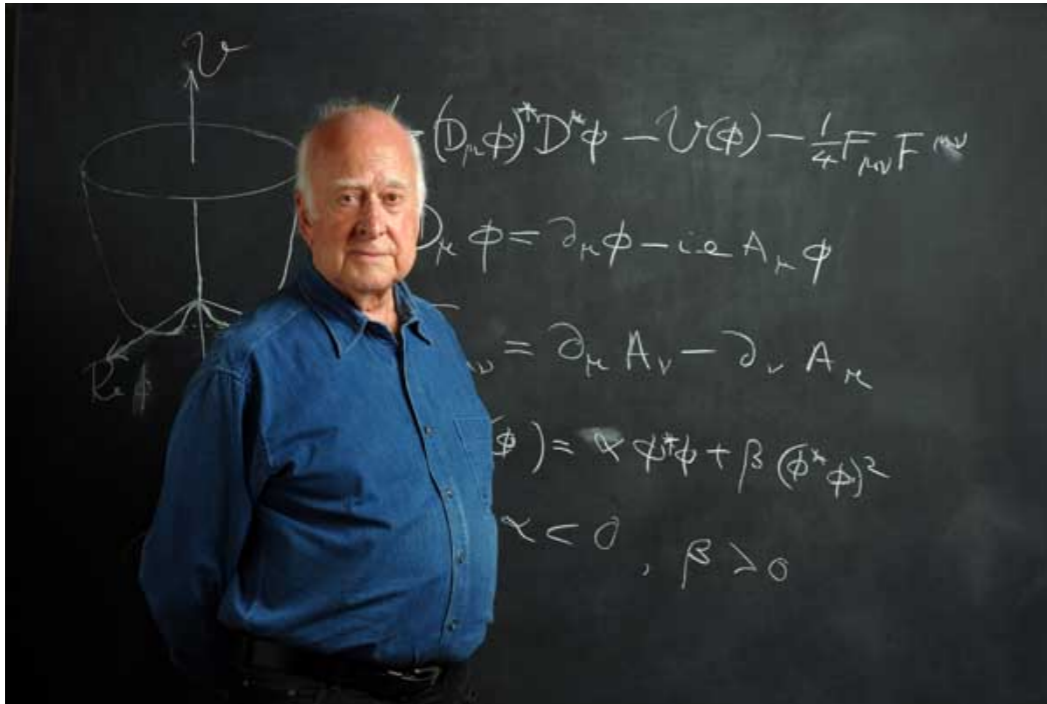

“This could be the discovery of the century. Depending, of course, on how far down it goes.”

... we have entered an era of significant changes

Most amazingly, LHC discovered a Higgs boson

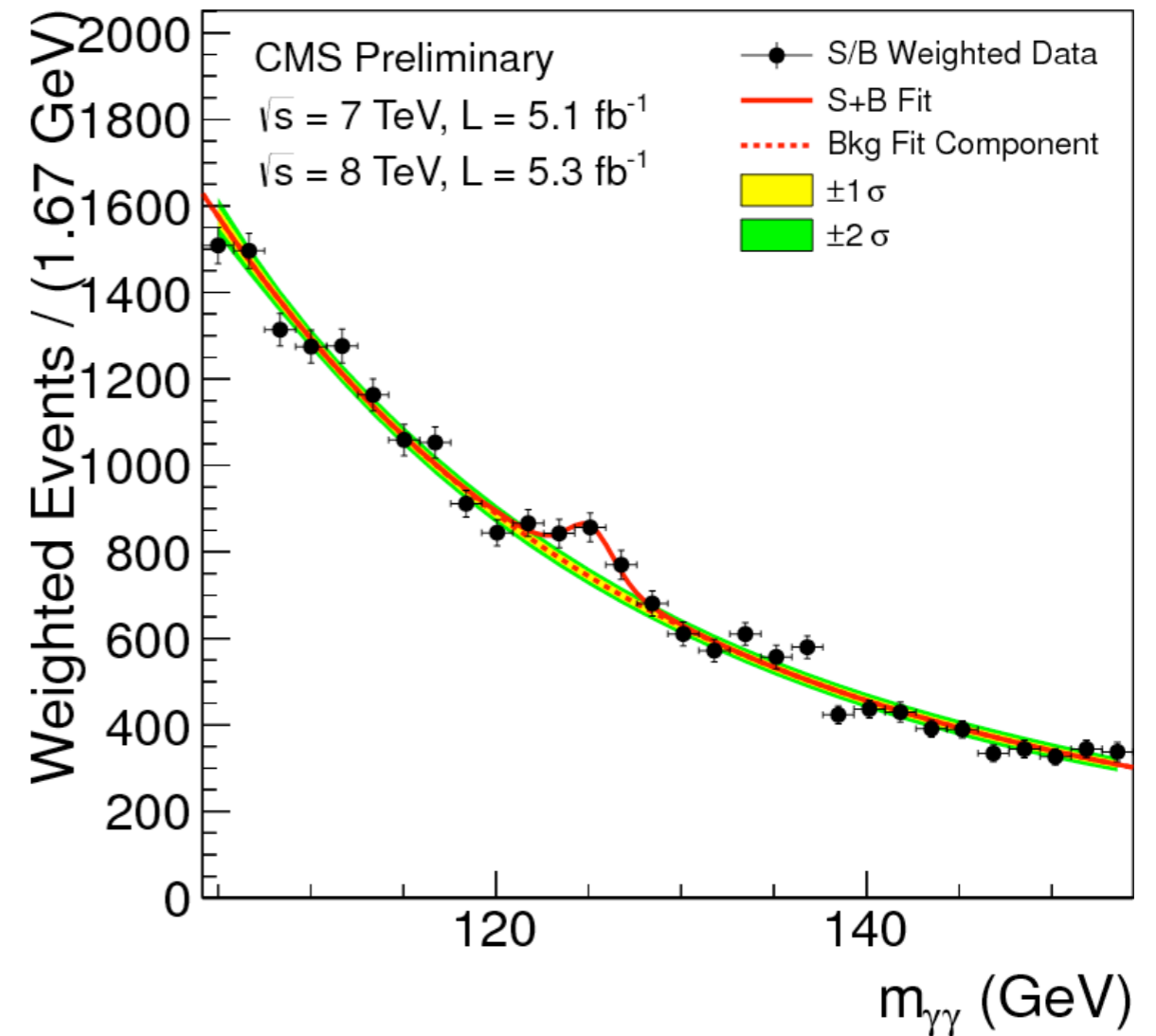
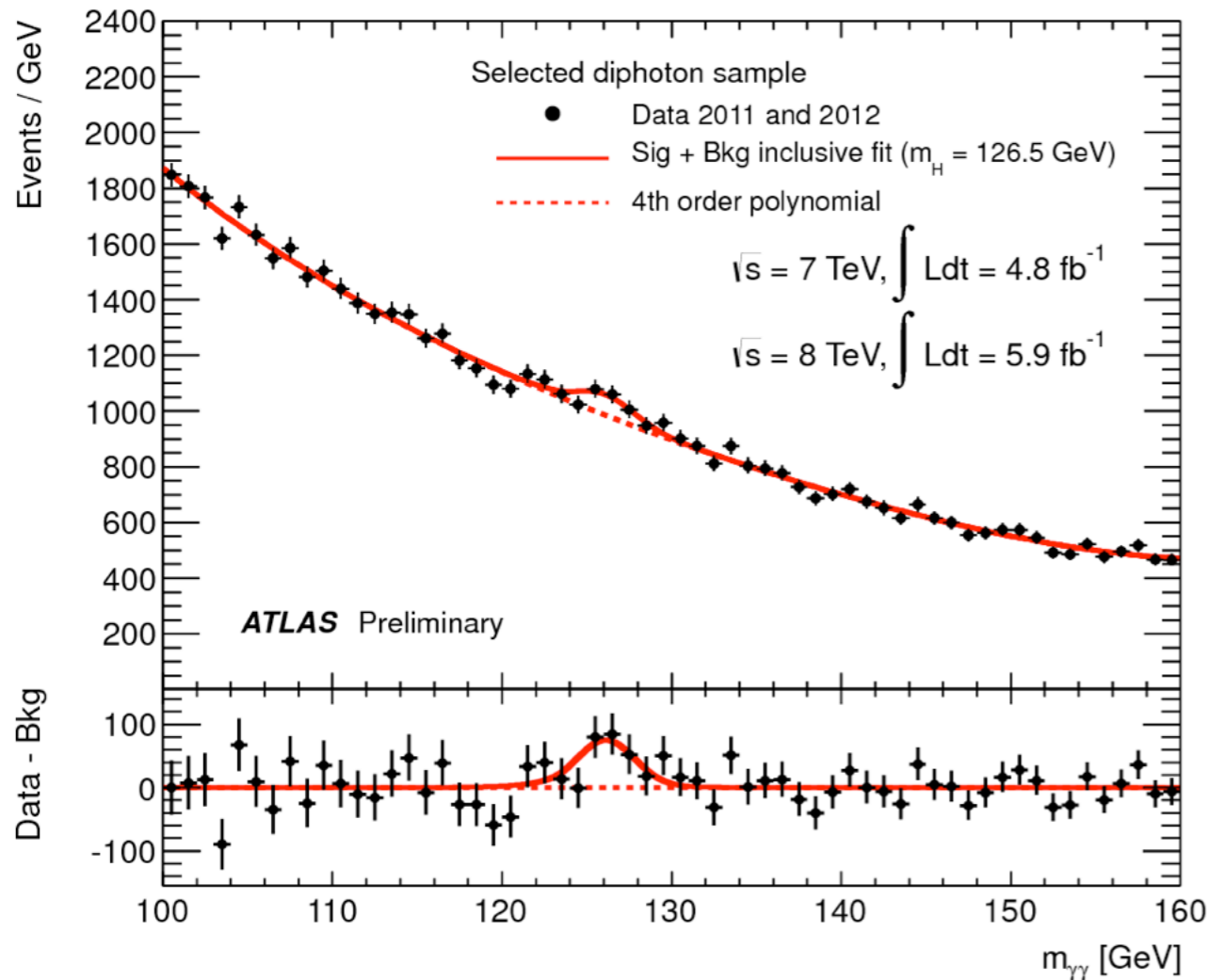

The most important discovery in 30 years !

Most amazingly, LHC discovered a Higgs boson

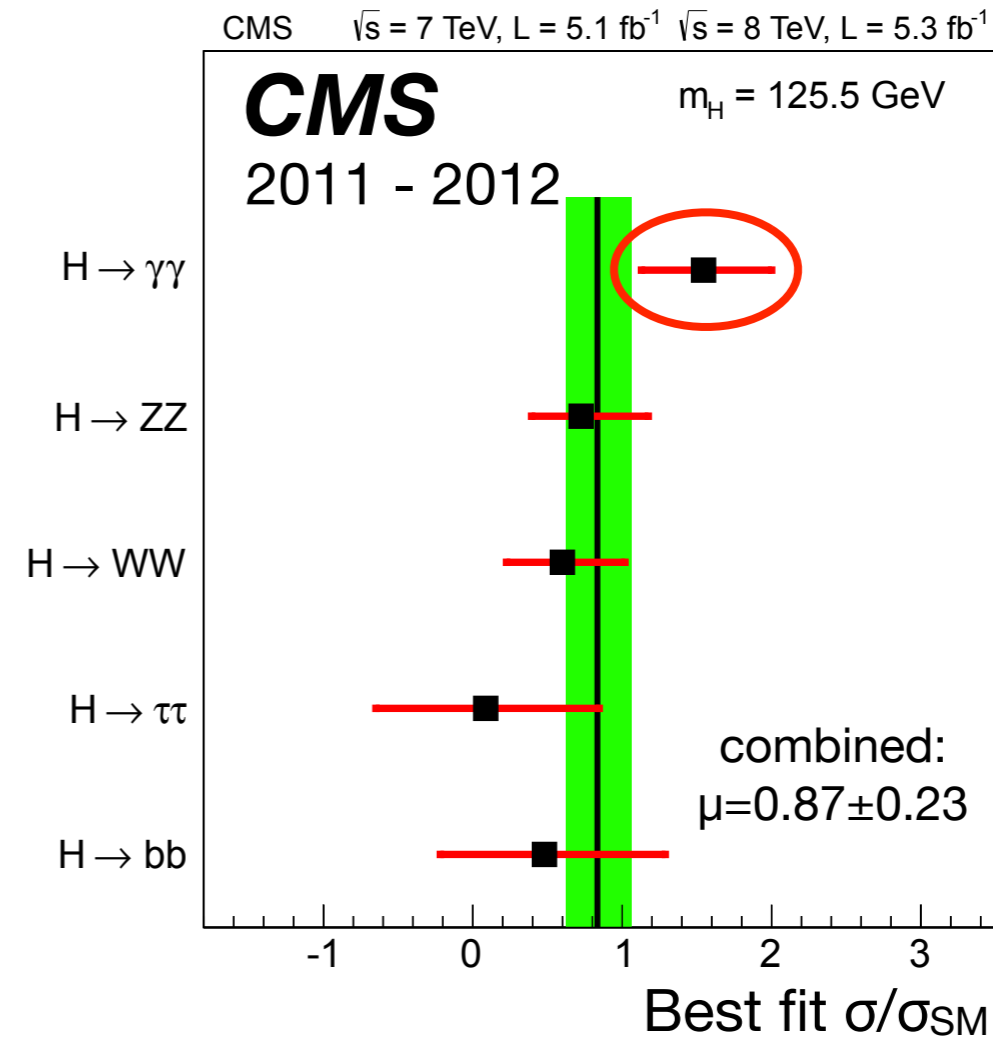
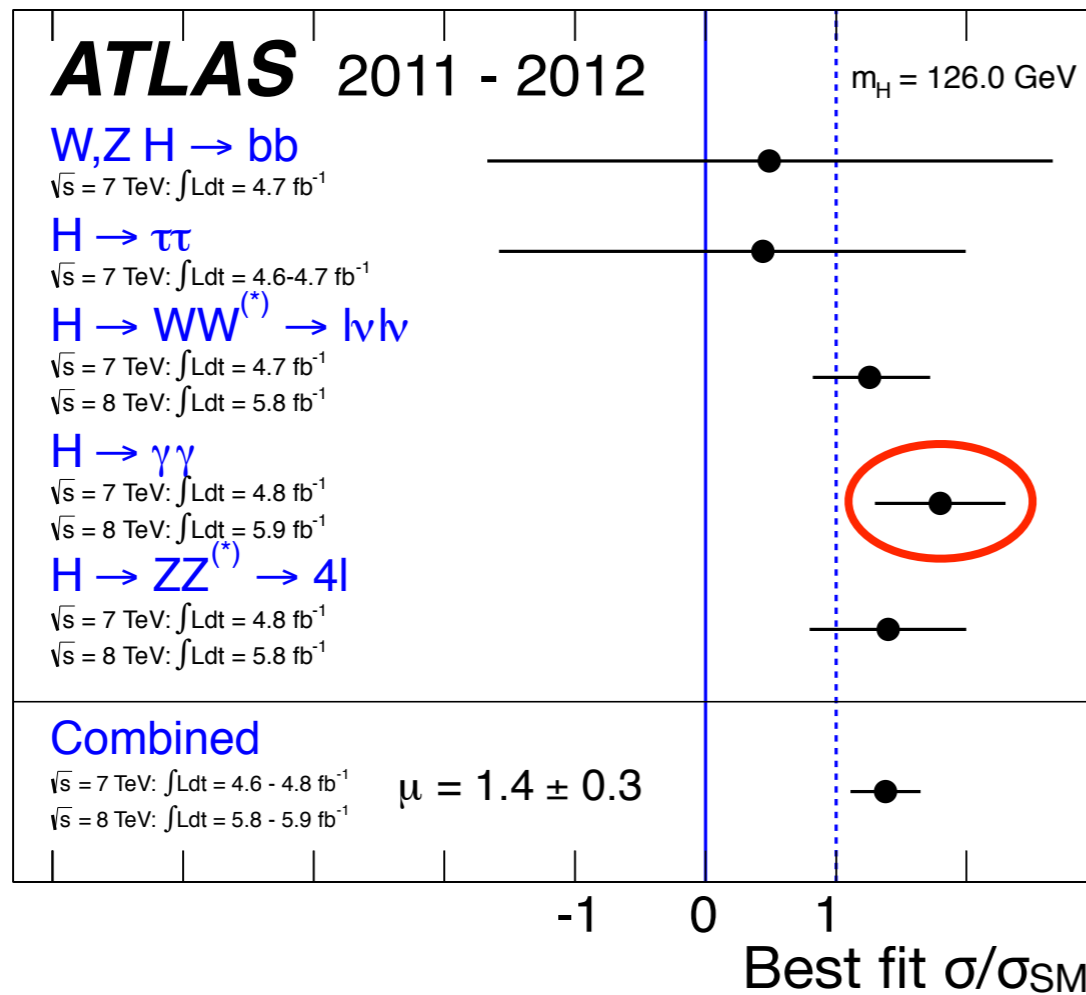

Preliminary indications:

- overall production rate agrees very well with SM
- decays to $ZZ+WW$ agree well with SM (ATLAS: 1.34 ± 0.38 , CMS: 0.67 ± 0.30)
- $h \rightarrow \gamma\gamma$ rate tends to be higher than SM, but perhaps we should not get too excited yet ...

Lecture I: Concepts of Quark Flavor Physics

Flavor physics as an indirect BSM probe

The **hierarchy problem** (mechanism of EWSB) and the **origin of flavor** are two big, unsolved mysteries of fundamental physics

- connected to deep questions such as the **origin of mass** of elementary particles, the **stability of the electroweak scale**, the **matter-antimatter asymmetry** in the Universe, the **origin of fermion generations**, and the reason for the **hierarchies** observed in the spectrum of fermion masses and mixing angles
- in SM, **flavor physics is connected to EWSB** via the Higgs Yukawa interactions

Higgs and flavor physics provide unique opportunities to probe the **structure of electroweak interactions at the quantum level**, thereby offering sensitive probes of physics beyond the SM

Following the **Higgs discovery** (July 2012), both routes can now be pursued with vigor

Flavor physics

- What is “flavor”?
- Generations: triplication of fermion spectrum without obvious necessity
- Dynamical explanation of flavor?
- Equally mysterious as dynamics of electroweak symmetry breaking
- Connection between two phenomena?

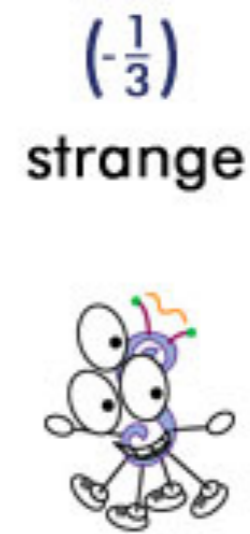

Flavor physics

- Hierarchies in fermion mass spectrum:

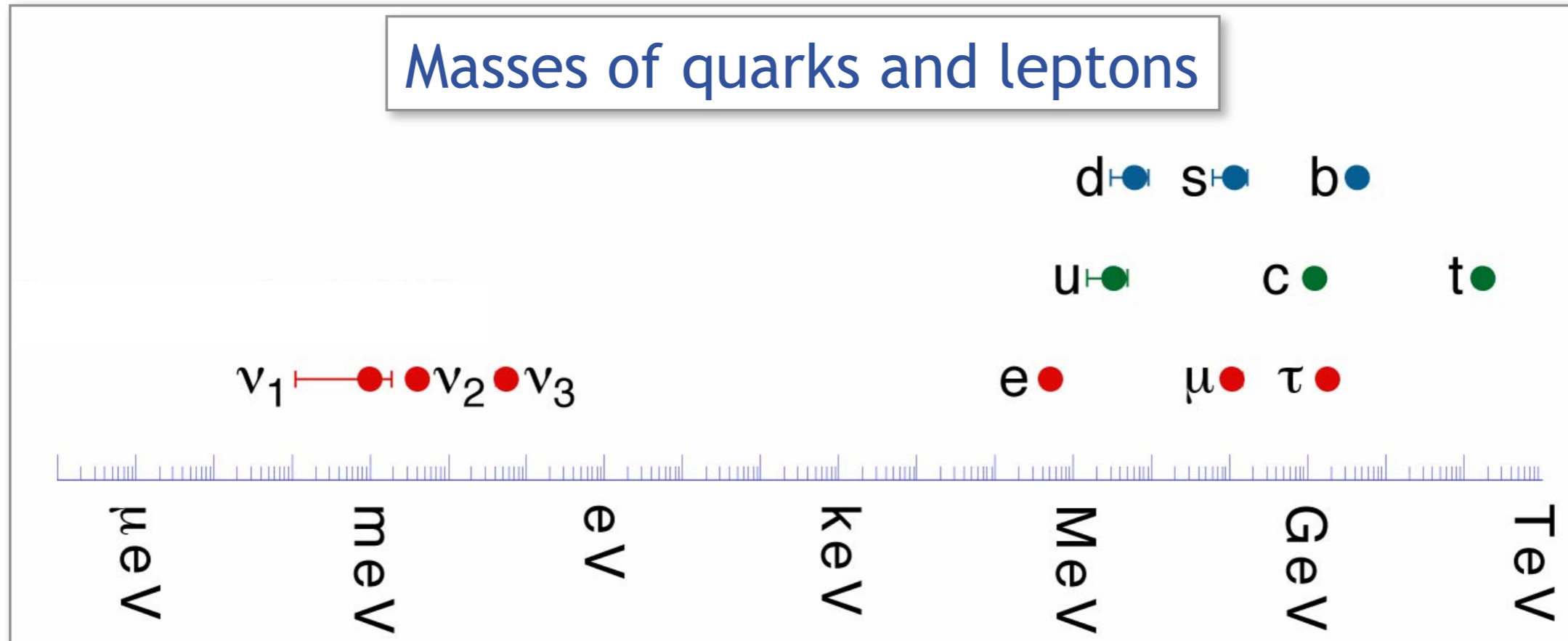

- Likewise, hierarchies in quark mixings

Flavor physics

- Flavor physics studies communication between different generations
- **Standard Model:** present only in charged-current interactions

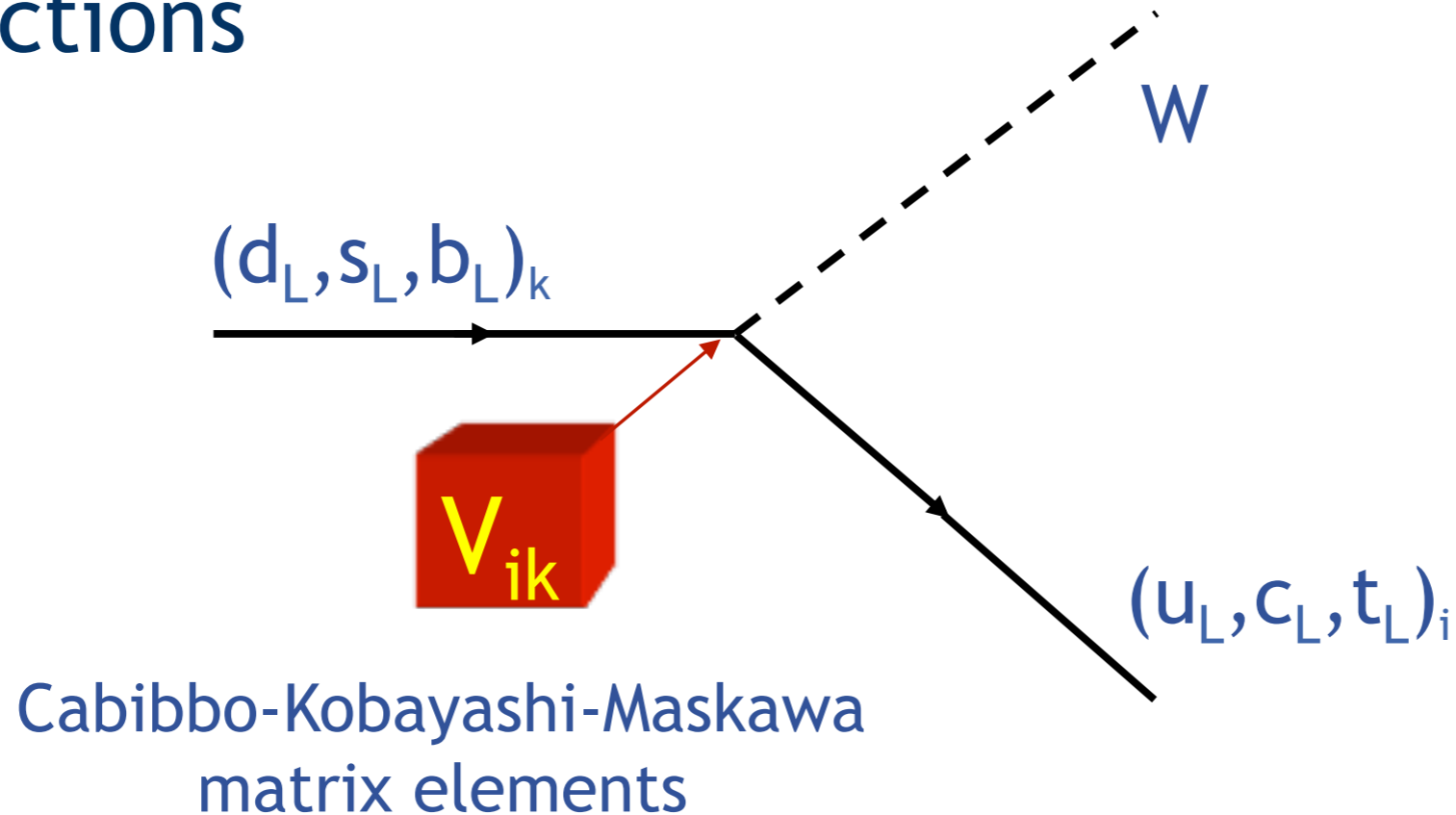

Yukawa couplings and CKM matrix

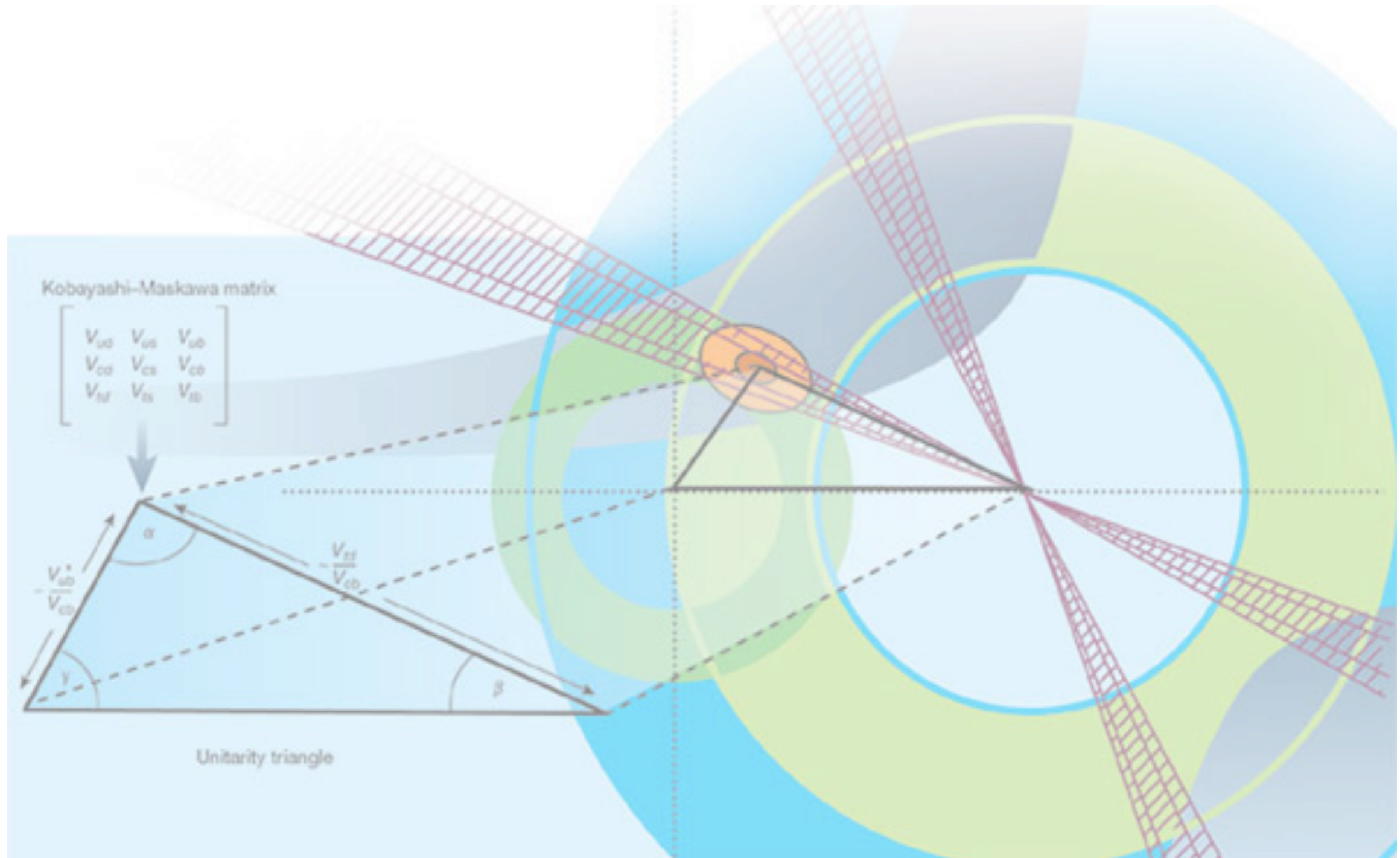

Yukawa couplings

- Most general, gauge invariant and renormalizable interactions of Higgs and matter fields:

generation index				$SU(2)_L$	$U(1)_Y$
L_L^i	$\begin{pmatrix} \nu_e \\ e_L \end{pmatrix}$	$\begin{pmatrix} \nu_\mu \\ \mu_L \end{pmatrix}$	$\begin{pmatrix} \nu_\tau \\ \tau_L \end{pmatrix}$	2	-1/2
Q_L^i	$\begin{pmatrix} u_L \\ d_L \end{pmatrix}$	$\begin{pmatrix} c_L \\ s_L \end{pmatrix}$	$\begin{pmatrix} t_L \\ b_L \end{pmatrix}$	2	+1/6
e_R^i	e_R	μ_R	τ_R	1	-1
u_R^i	u_R	c_R	t_R	1	+2/3
d_R^i	d_R	s_R	b_R	1	-1/3

Yukawa couplings

$$\Phi : \begin{pmatrix} \phi_1^+ \\ \phi_2^0 \end{pmatrix}, \quad \tilde{\Phi} = i\sigma_2 \Phi^* : \begin{pmatrix} \phi_2^{*0} \\ -\phi_1^{*-} \end{pmatrix} \quad \begin{array}{cc} \text{SU}(2)_L & \text{U}(1)_Y \\ 2 & \pm 1/2 \end{array}$$

- Yukawa couplings:

$$\mathcal{L}_Y = -\bar{e}_R^i Y_e^{ij} \Phi^\dagger L_L^j - \bar{d}_R^i Y_d^{ij} \Phi^\dagger Q_L^j - \bar{u}_R^i Y_u^{ij} \tilde{\Phi}^\dagger Q_L^j + \text{h.c.}$$

$$Y: \quad \begin{array}{cccccc} 1 & -1/2 & -1/2 & 1/3 & -1/2 & +1/6 & -2/3 & +1/2 & +1/6 \end{array}$$

- Y_e, Y_d, Y_u : arbitrary complex 3x3 matrices
- Electroweak symmetry breaking: $\langle \phi_2^0 \rangle = v/\sqrt{2}$

Yukawa couplings

- Gauge principle allows arbitrary generation-changing interactions, since fermions of different generations have equal gauge charges!
- Usually such couplings are eliminated by field redefinitions:

$$\psi^i \rightarrow U^{ij} \psi^j$$

unitary (i.e., probability preserving) “rotation” in generation space

Yukawa couplings

- Diagonalize Yukawa matrices using biunitary transformations, e.g.:

$$Y_e = W_e \lambda_e U_e^\dagger; \quad \lambda_e = \begin{pmatrix} y_e & 0 & 0 \\ 0 & y_\mu & 0 \\ 0 & 0 & y_\tau \end{pmatrix}$$

- Then perform field redefinitions:

$$e_L \rightarrow U_e e_L, \quad e_R \rightarrow W_e e_R$$

$$u_L \rightarrow U_u u_L, \quad u_R \rightarrow W_u u_R$$

$$d_L \rightarrow U_d d_L, \quad d_R \rightarrow W_d d_R$$

- This diagonalizes the mass terms, giving masses $m_f = y_f (v/\sqrt{2})$ to all fermions

CKM matrix

- Effect of field redefinitions on weak interactions in the mass basis (QCD and QED invariant)
- Charged currents:

$$\mathcal{L}_{cc} = \frac{g_2}{\sqrt{2}} W^\mu (\bar{u}_L, \bar{c}_L, \bar{t}_L) \gamma_\mu V \begin{pmatrix} d_L \\ s_L \\ b_L \end{pmatrix} + \text{h.c.}; \quad V = U_u^\dagger U_d$$

- generation changing couplings proportional to V_{ij} :

$$d_L^i \rightarrow u_L^j + W^- \propto V_{ji} \quad u_L^i \rightarrow d_L^j + W^+ \propto V_{ij}^*$$

(Cabibbo-Kobayashi-Maskawa matrix)

CKM matrix

- Neutral currents:

$$\mathcal{L}_{\text{nc}} = \frac{g_2}{\cos \theta_W} Z^\mu \sum_f \left[\bar{f}_L U_f^\dagger \left(T_f^3 \frac{1 - \gamma_5}{2} - Q_f \sin^2 \theta_W \right) U_f f_L \right. \\ \left. + \bar{f}_R W_f^\dagger \left(-Q_f \sin^2 \theta_W \right) W_f f_R \right]$$

cancel each other

- no generation-changing interactions!
(at level of elementary vertices)
- GIM mechanism (Glashow-Iliopoulos-Maiani, 1970)
- led to prediction of charm quark (K- \bar{K} mixing)

CKM matrix

- Unitary 3x3 matrix V can be parameterized by 3 Euler angles and 6 phases
- Not all phases are observable, since under phase redefinitions $q \rightarrow e^{i\varphi_q} q$ of the quark fields:

$$V \rightarrow \begin{pmatrix} e^{-i\varphi_u} & 0 & 0 \\ 0 & e^{-i\varphi_c} & 0 \\ 0 & 0 & e^{-i\varphi_t} \end{pmatrix} V \begin{pmatrix} e^{i\varphi_d} & 0 & 0 \\ 0 & e^{i\varphi_s} & 0 \\ 0 & 0 & e^{i\varphi_b} \end{pmatrix}, \quad V_{ij} \rightarrow e^{i(\varphi_d^i - \varphi_u^j)} V_{ij}$$

- 5 of 6 phases can be eliminated by suitable choices of phase differences!

CKM matrix

- Remaining phase δ_{CKM} is source of all CP-violating effects in Standard Model (assuming $\theta_{\text{QCD}}=0$)
 - weak interactions couple to left-handed fermions and right-handed antifermions
 - violate **P** and **C** maximally, but would be invariant under **CP** and **T** if all weak couplings were real
 - physical phase of CKM matrix breaks CP invariance
- Allows for an absolute distinction between matter and antimatter!

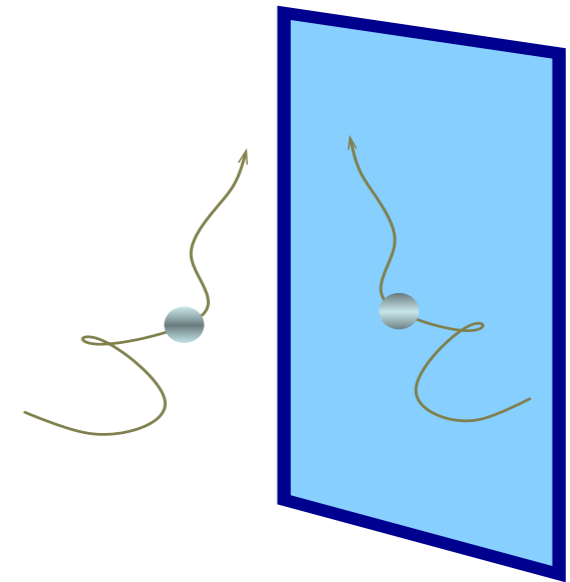



SCIENCE AND TECHNOLOGY NEWS | THE WEEK'S BEST IDEAS

NewScientist

April 24-30, 2004

INSIDE
THE BEST JOBS
IN NEW ENGLAND

ANTIMATTER'S NEMESIS

The power to generate new atomic worlds



WORLD FIRST
THE MOUSE WITH TWO MOTHERS

US\$4.95 CAN\$5.95 £2.50 No2444



0 71486 01115 6 17

CKM matrix

- CP violation required to explain the different abundances of matter and antimatter in the universe (baryogenesis)
- CP violation in quark sector requires $N \geq 3$ fermion generations
- Model for explanation of CP violation led to prediction of the third generation!
Kobayashi, Maskawa (1973)

CKM matrix

- Form of V not unique (phase conventions)
- Several parameterizations used; a very useful one is due to [Wolfenstein \(1983\)](#):

$$V = \begin{pmatrix} V_{ud} & V_{us} & V_{ub} \\ V_{cd} & V_{cs} & V_{cb} \\ V_{td} & V_{ts} & V_{tb} \end{pmatrix} = \begin{pmatrix} 1 - \frac{\lambda^2}{2} & \lambda & A\lambda^3(\rho - i\eta) \\ -\lambda & 1 - \frac{\lambda^2}{2} & A\lambda^2 \\ A\lambda^3(1 - \rho - i\eta) & -A\lambda^2 & 1 \end{pmatrix} + O(\lambda^4)$$

- Hierarchical structure in $\lambda \approx 0.22$
- Remaining parameters $O(1)$
- Complex entries $O(\lambda^3)$

Large teal square	Medium blue square	Small red square
Medium blue square	Large teal square	Small light blue square
Small red square	Small light blue square	Large teal square

CKM matrix

- Jarlskog determinant:
for arbitrary choice of i, j, k, l the quantity

$$\text{Im}(V_{ij}V_{kl}V_{il}^*V_{kj}^*) = J \sum_{m,n} \epsilon_{ikm} \epsilon_{jln}$$

is an invariant of the CKM matrix (independent of phase conventions)

- CP invariance is broken if and only if $J \neq 0$
- Wolfenstein parameterization:

$$J = O(\lambda^6) = O(10^{-4}) \quad \text{rather small}$$

Unitarity triangle

- Unitarity relation $V^\dagger V = V V^\dagger = 1$ implies:

$$V_{ji}^* V_{jk} = \delta_{ik} \quad \text{and} \quad V_{ij}^* V_{kj} = \delta_{ik}$$

- For $i \neq k$ this gives 6 triangle relations, in which a sum of 3 complex numbers adds up to zero:

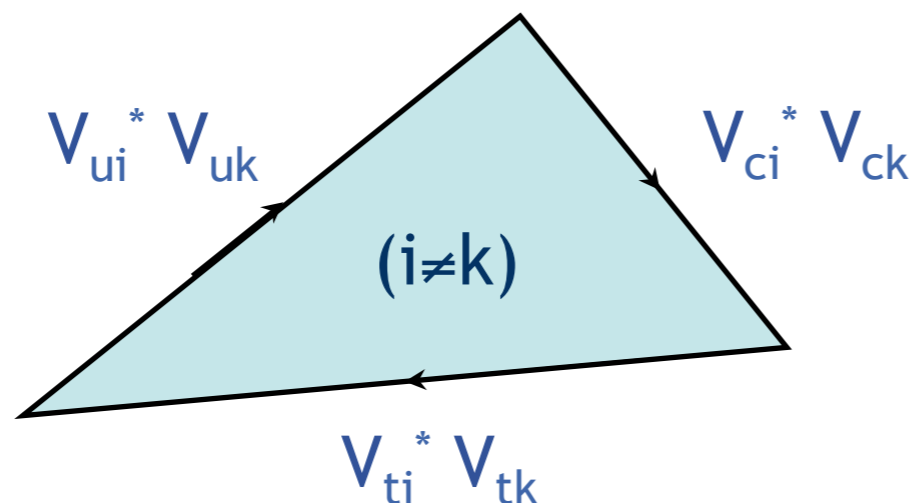

$$\text{area} = J/2$$

Unitarity triangle

- Phase redefinitions turn triangles
- For two triangles, all sides are of same order in λ ; *the* unitarity triangle is:

$$V_{ub}^* V_{ud} + V_{cb}^* V_{cd} + V_{tb}^* V_{td} = 0$$

- Graphical representation:

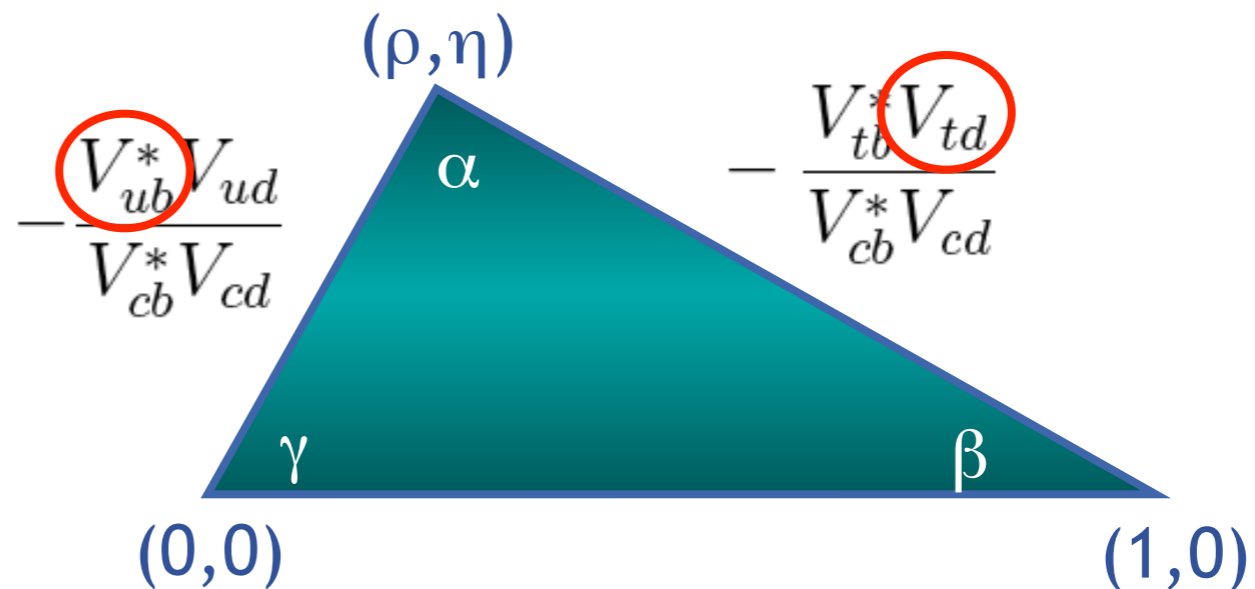

Present knowledge of the unitarity triangle

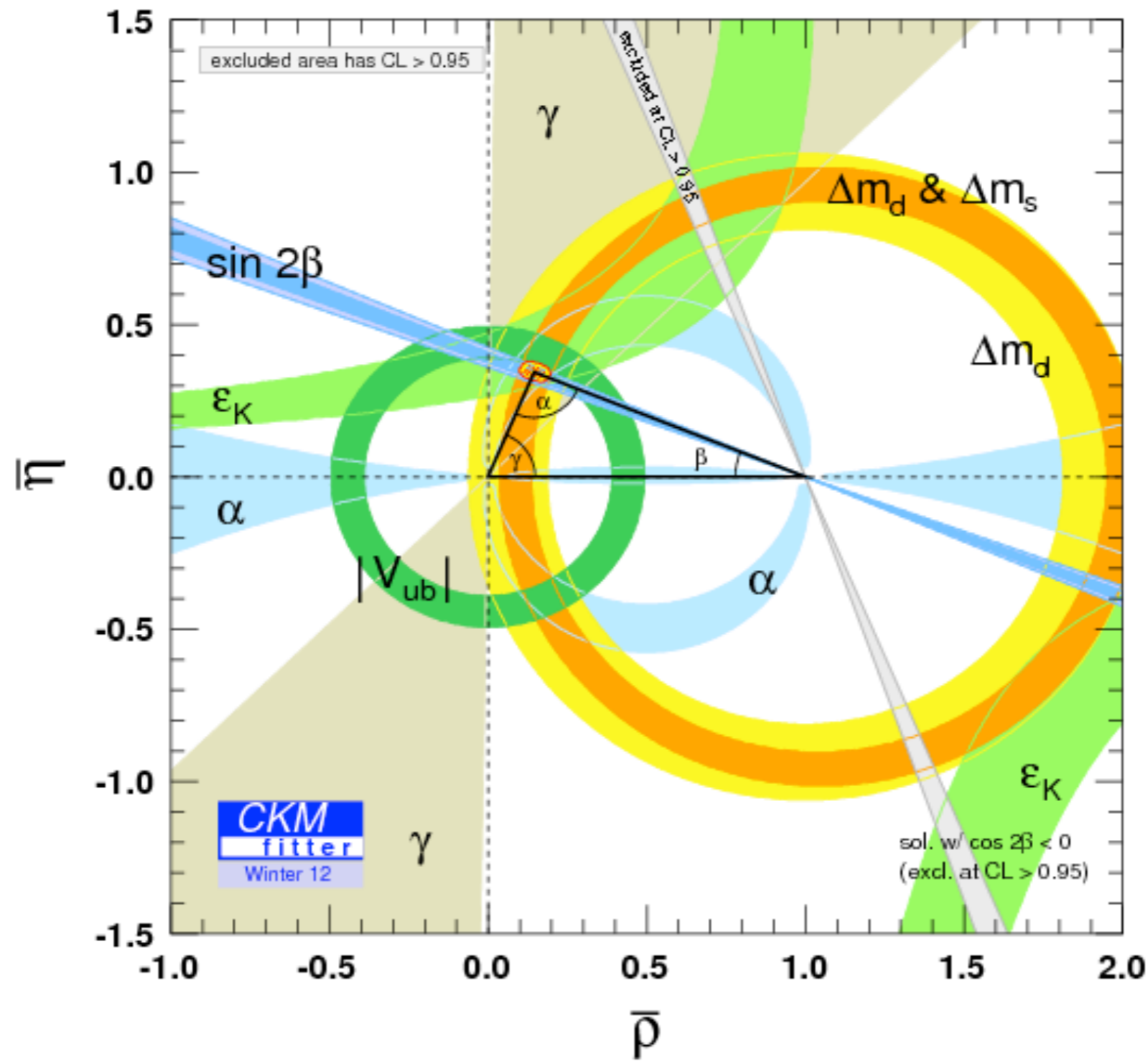

Oscillations of neutral mesons

- Neutral mesons can be transformed into their antiparticles by second-order weak processes
- Analogy with quantum-mechanical system of coupled pendulums: state B^0 at $t=0$ develops into a superposition of states B^0 and \bar{B}^0 with time-oscillating amplitudes

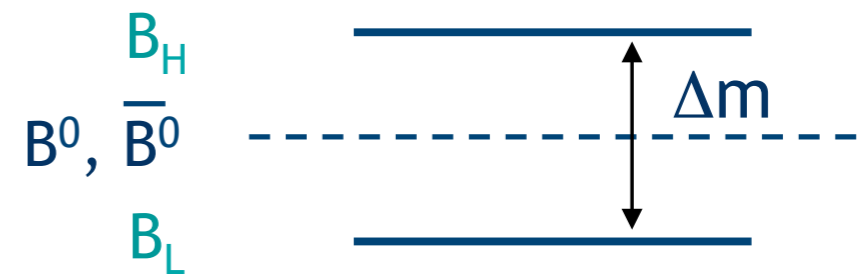
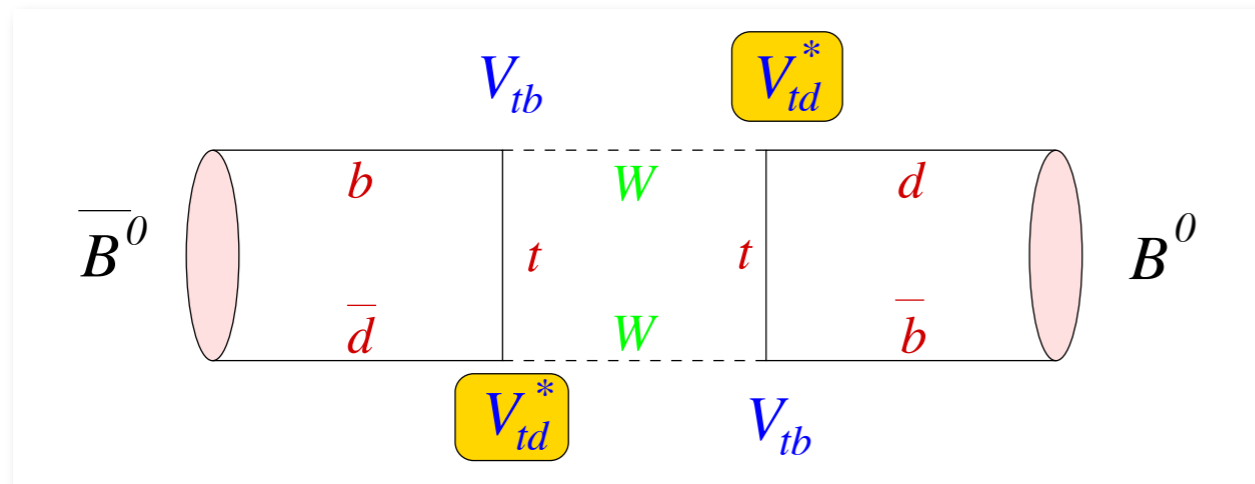

Oscillations of neutral mesons

- B-factories produce pairs of B^0 and \bar{B}^0 mesons in coherent quantum states

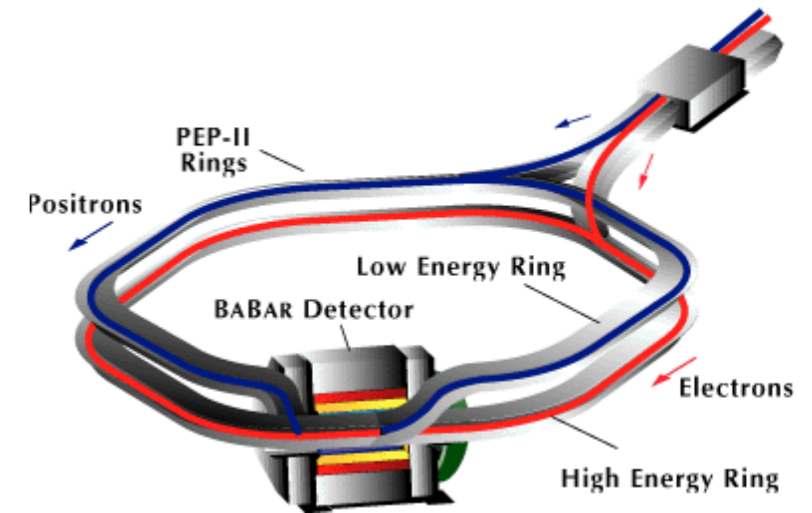
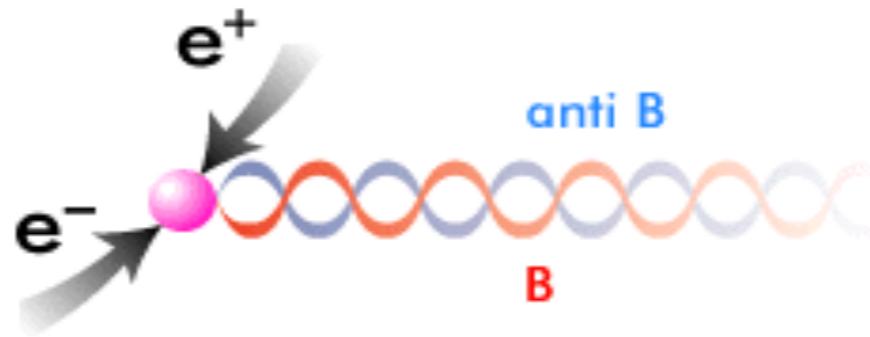

- Decay of one meson (with reconstruction of its flavor) initiates time measurement for the other meson

Quantum-mechanical treatment

(neglect exponential decay for simplicity)

- Schrödinger equation for B^0 and \bar{B}^0 :

$$i \frac{d}{dt} \begin{pmatrix} B^0 \\ \bar{B}^0 \end{pmatrix} = \begin{pmatrix} M & \frac{1}{2} e^{-2i\beta} \Delta m \\ \frac{1}{2} e^{2i\beta} \Delta m & M \end{pmatrix} \begin{pmatrix} B^0 \\ \bar{B}^0 \end{pmatrix}, \quad \text{mass eigenvalues:}$$

$$M_{\pm} = M \pm \frac{\Delta m}{2}$$

- Non-diagonal entry due to box diagram:

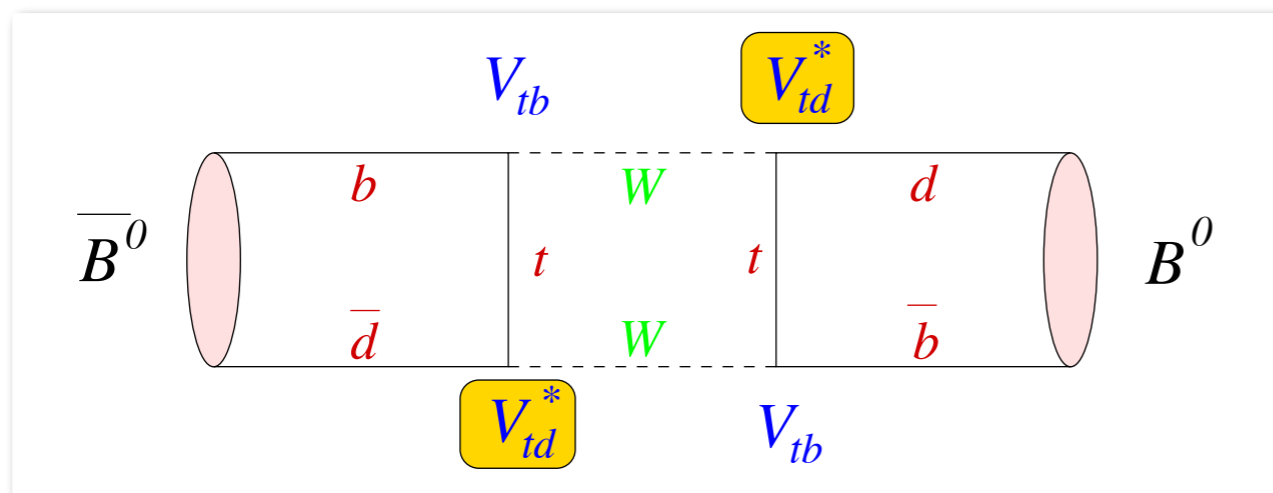

$$\propto (V_{tb} V_{td}^*)^2 \propto e^{2i\beta}$$

Quantum-mechanical treatment

(neglect exponential decay for simplicity)

- Schrödinger equation for B^0 and \bar{B}^0 :

$$i \frac{d}{dt} \begin{pmatrix} B^0 \\ \bar{B}^0 \end{pmatrix} = \begin{pmatrix} M & \frac{1}{2} e^{-2i\beta} \Delta m \\ \frac{1}{2} e^{2i\beta} \Delta m & M \end{pmatrix} \begin{pmatrix} B^0 \\ \bar{B}^0 \end{pmatrix}, \quad \text{mass eigenvalues: } M_{\pm} = M \pm \frac{\Delta m}{2}$$

- Non-diagonal entry due to box diagram:

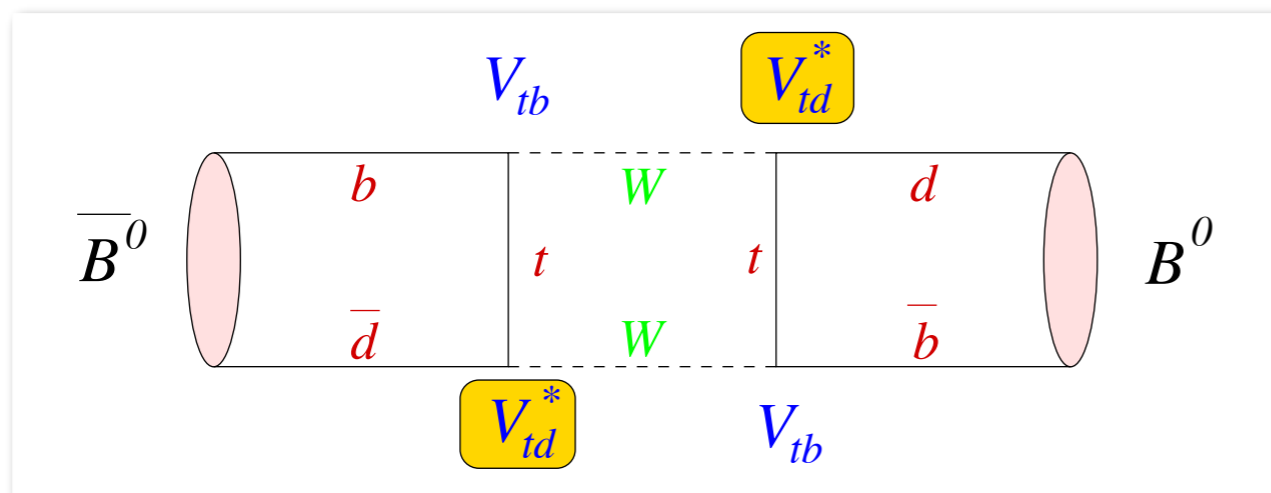

$$\propto (V_{tb} V_{td}^*)^2 \propto e^{2i\beta}$$

- Time evolution of an initial (at $t=0$) \bar{B}^0 state:

$$|\psi(t)\rangle = e^{-iMt} \left[\cos\left(\frac{1}{2}\Delta mt\right) |\bar{B}^0\rangle + ie^{2i\beta} \sin\left(\frac{1}{2}\Delta mt\right) |B^0\rangle \right]$$

Oscillations of neutral mesons

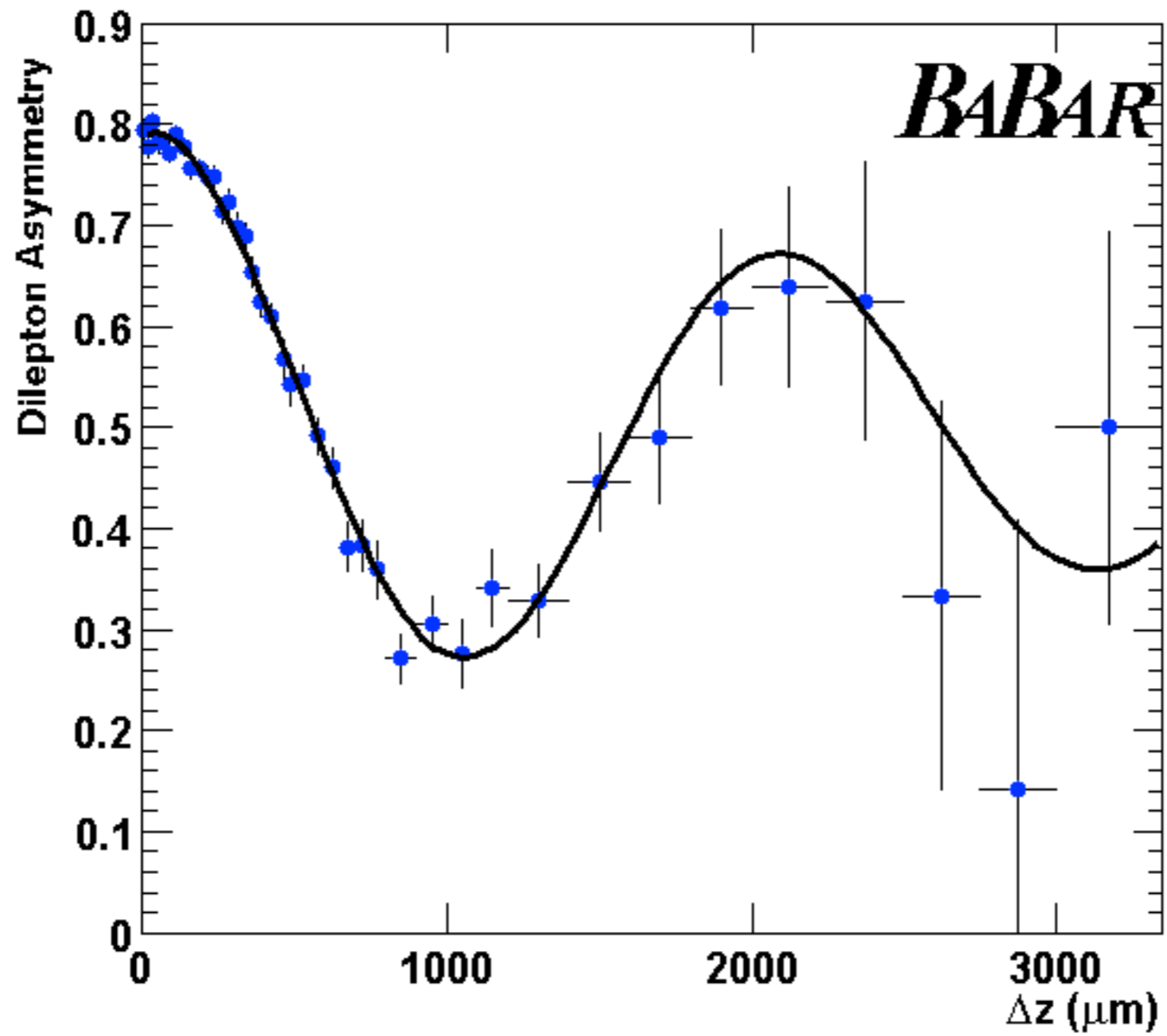

Determination of $|V_{td}|$ from Δm

- Master formula:

$$\Delta m = \frac{G_F^2 M_W^2}{16\pi^2} |V_{tb} V_{td}^*|^2 S_0\left(\frac{m_t^2}{M_W^2}\right) \eta_{\text{QCD}} \frac{1}{m_B} \langle B^0 | (\bar{d}b)_{V-A} (\bar{d}b)_{V-A} | \bar{B}^0 \rangle$$

$$S_0(x_t) \approx 0.784 x_t^{0.76}$$

perturbative QCD
correction

$$\equiv \frac{8}{3} B_B f_B^2 m_B^2$$

(from lattice QCD)

- Discovery of B- \bar{B} mixing (ARGUS experiment, 1987) pointed to a very heavy top quark!

Determination of $|V_{td}|$ from Δm

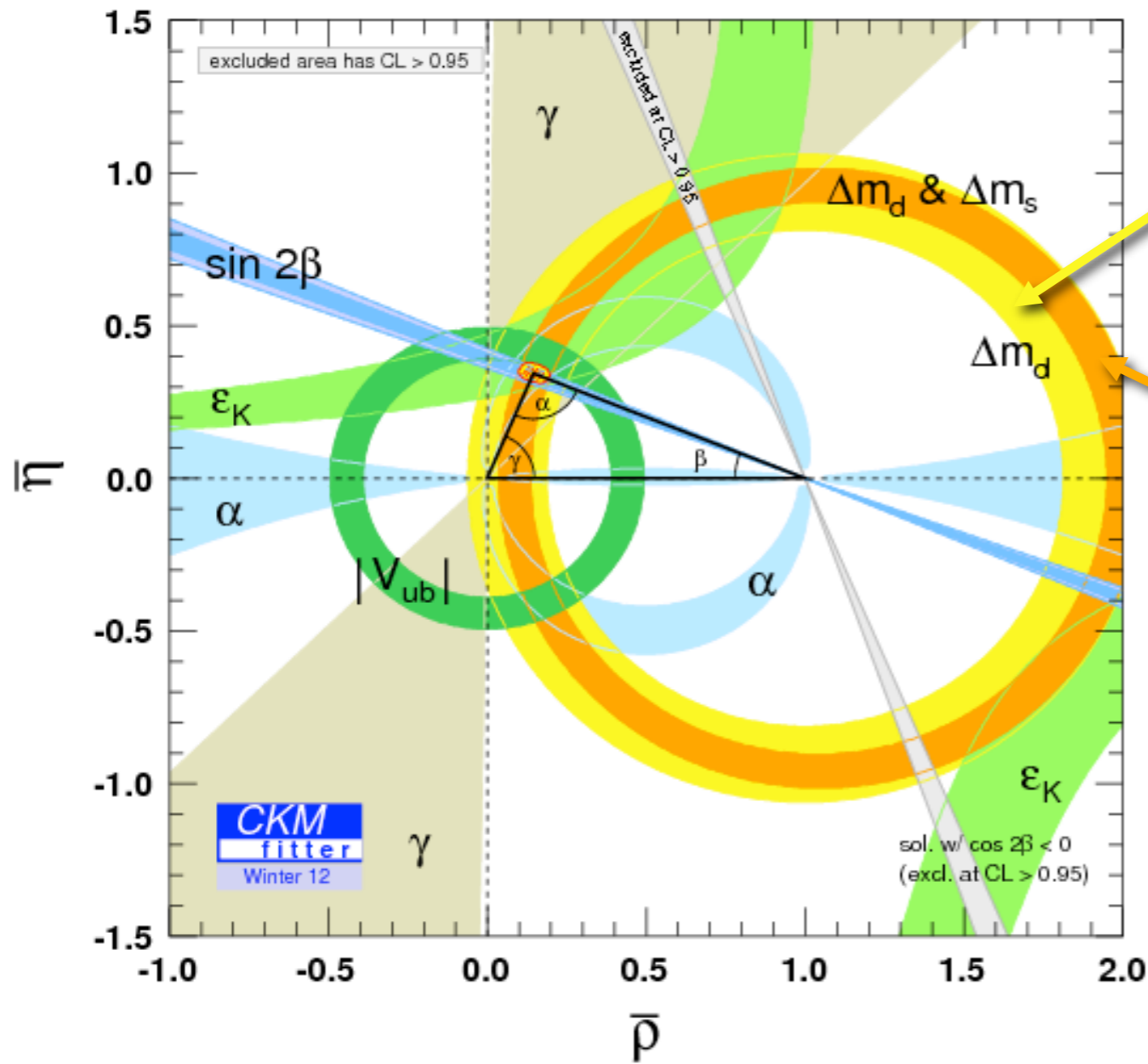

result derived from B_d mixing alone
(large theoretical uncertainties)

result derived from ratio of B_d and B_s mixing frequencies
(reduced theoretical uncertainties)

$$\frac{\Delta m(B_d)}{\Delta m(B_s)} = \left| \frac{V_{td}}{V_{ts}} \right|^2 \frac{B_{B_d} f_{B_d}^2 m_{B_d}}{B_{B_s} f_{B_s}^2 m_{B_s}}$$

Some more constraints on the unitarity triangle

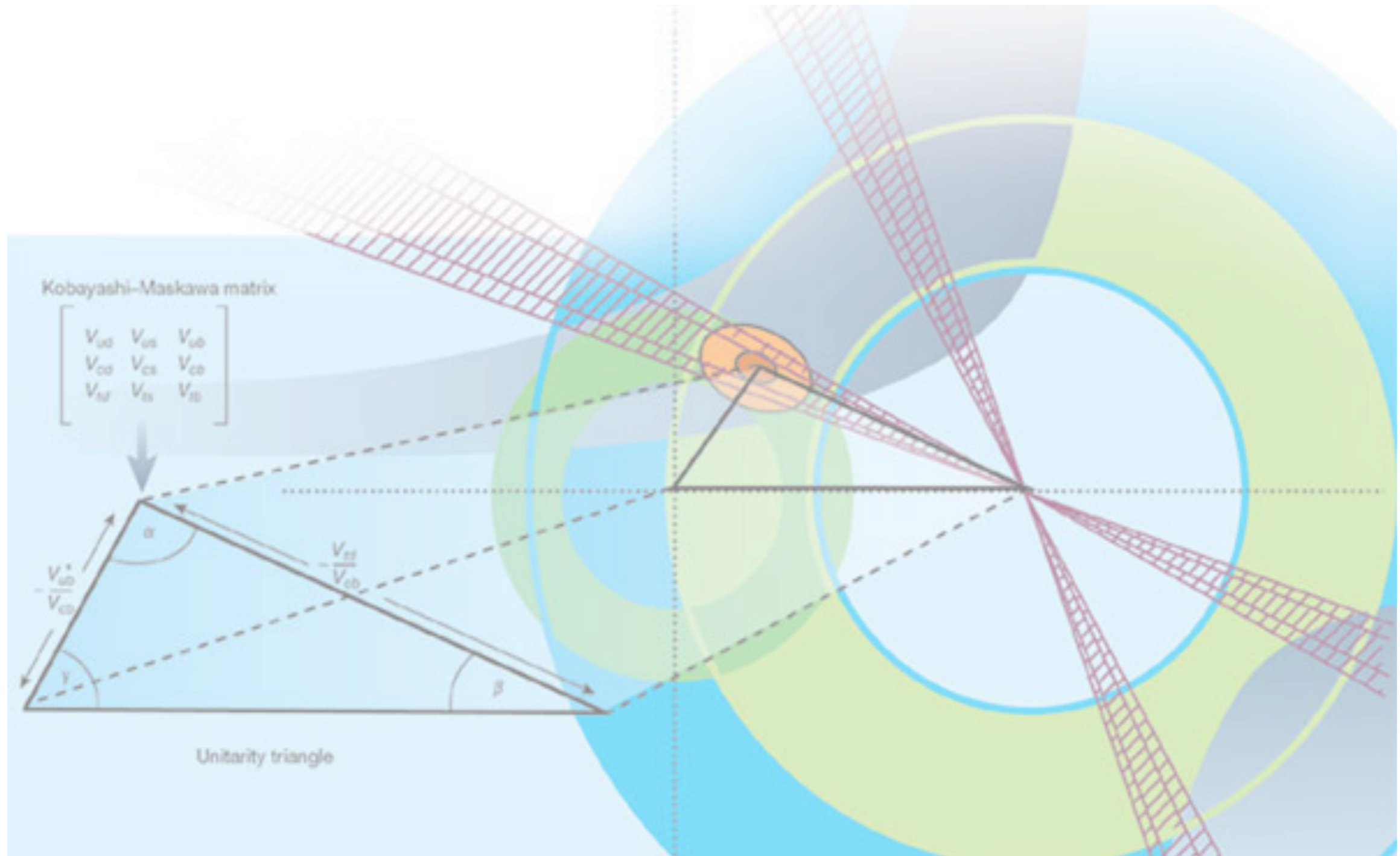

Determination of $\text{Im}(V_{td}^2)$ from kaon mixing

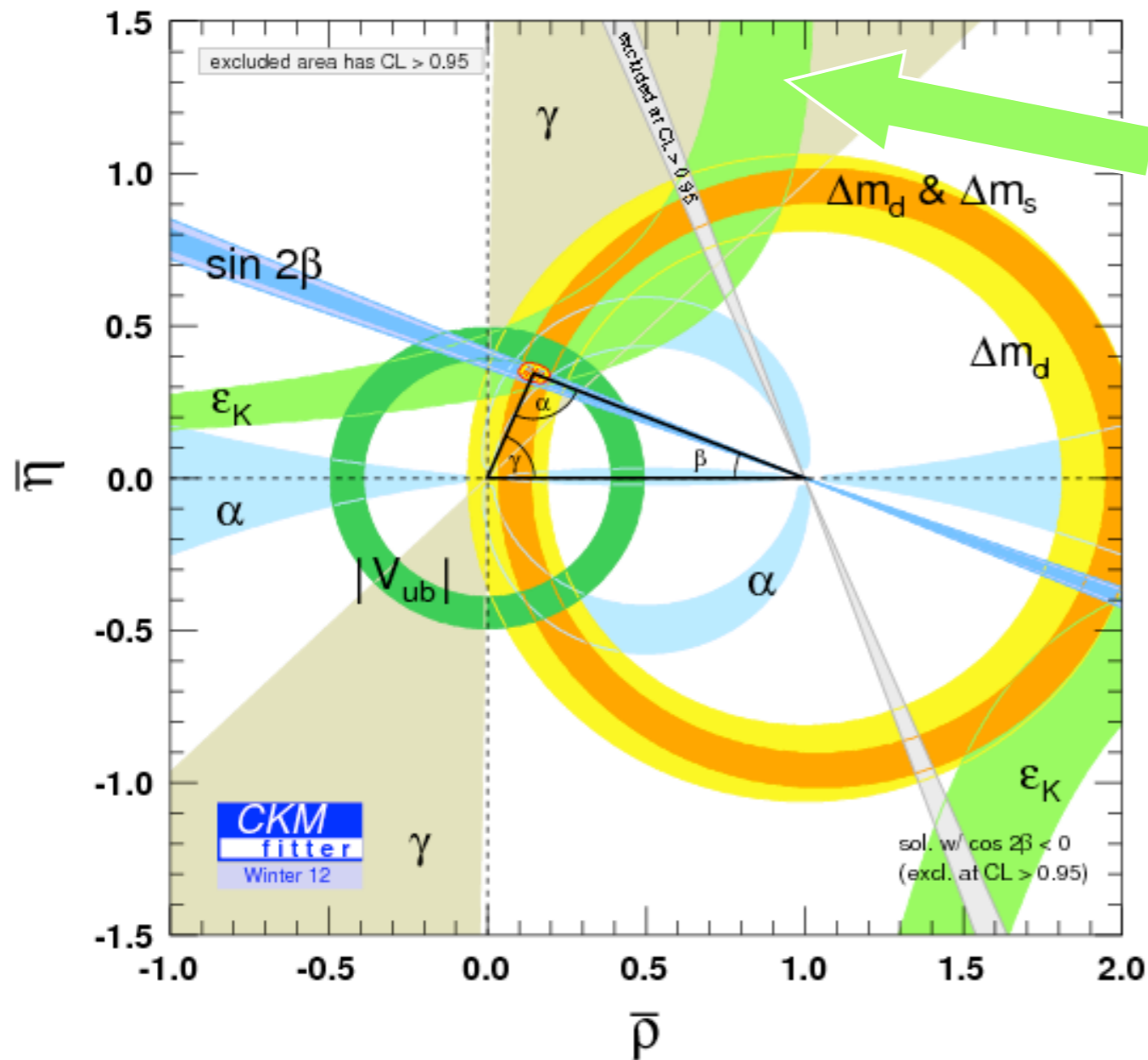

- Determination of $\text{Im}(V_{td}^2)$ from CP violation in K^0 - \bar{K}^0 mixing
- Large hadronic uncertainties (lattice QCD)

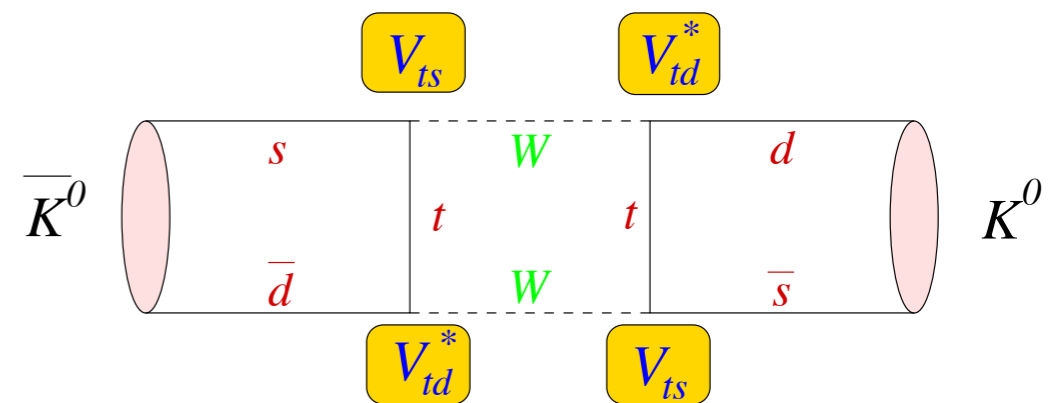

Determination of $|V_{ub}|$ from semileptonic decays

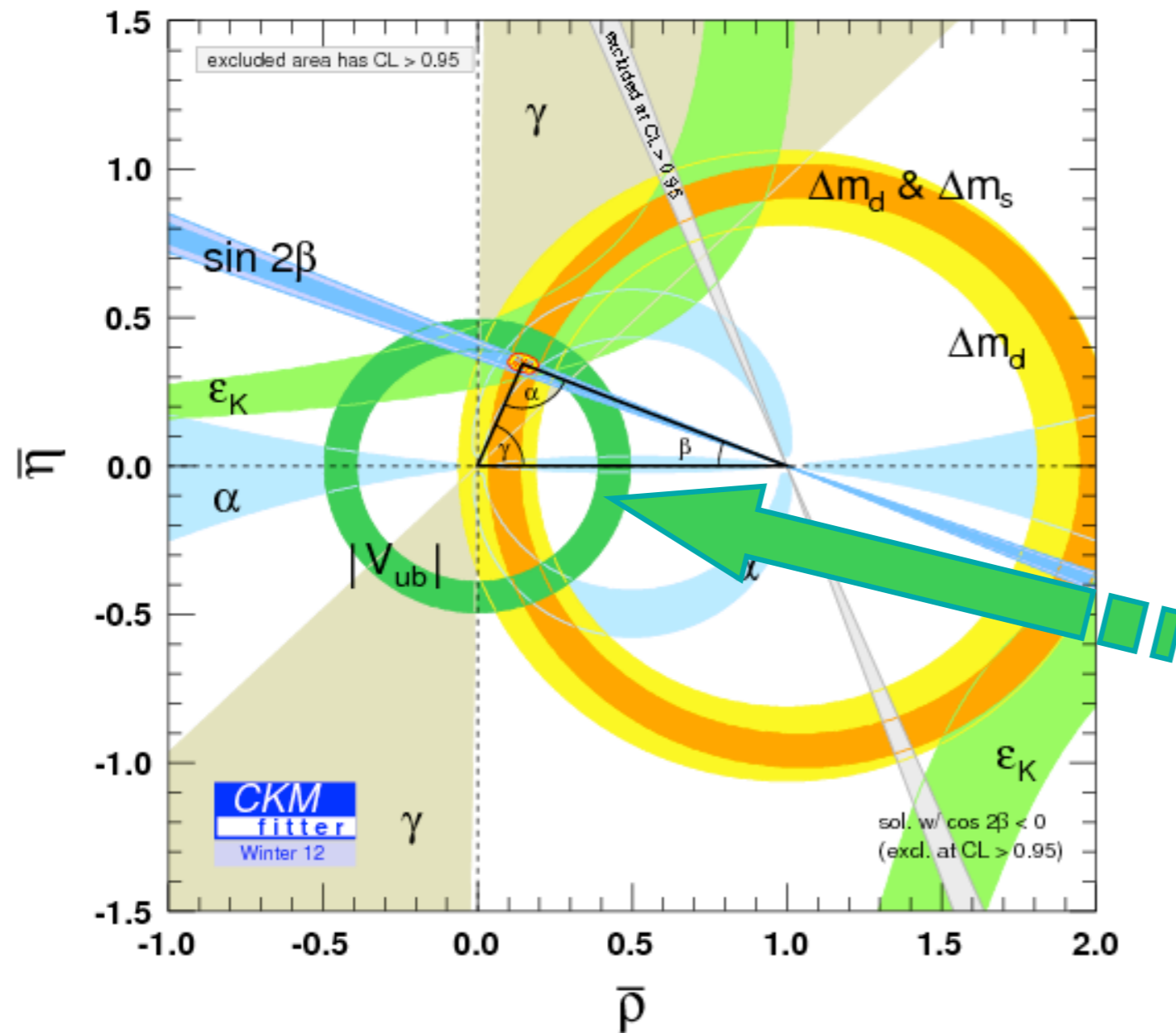

- Determination of $|V_{ub}|$ in inclusive and exclusive semileptonic B decays

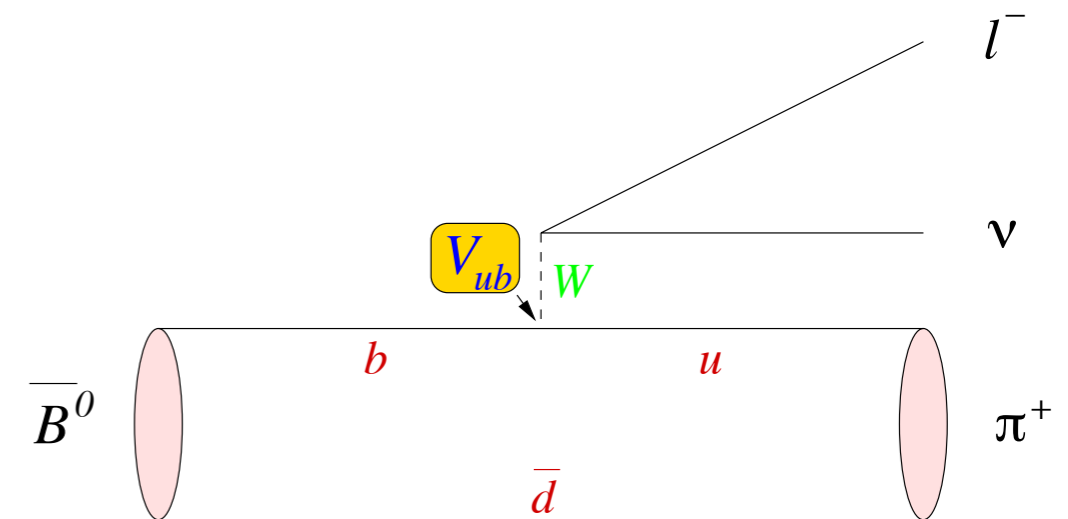

Quark flavor physics

Lecture I: Concepts of Quark Flavor Physics

- Introduction and motivation
- Yukawa couplings, CKM matrix, unitarity triangle
- Neutral meson mixing, some UT determinations

Lecture II: Indirect Searches for New Physics

- CP violation in the interference of mixing and decay
- Effective weak interactions
- Testing the Standard Model with rare FCNC processes

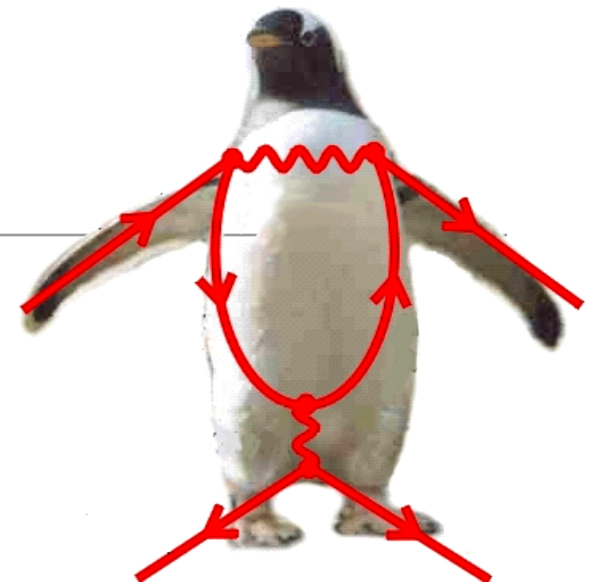

A more subtle quantum-mechanical effect:

Study **interference of mixing and decay** in neutral B-meson decays into CP eigenstates

Time-dependent CP asymmetry provides **direct access to angles** of the unitarity triangle

To see how this works, use our previous result for the time dependence of an initial \bar{B}^0 state (at $t=0$)

CP violation in interference of mixing and decay

- Time evolution of an initial (at $t=0$) \bar{B}^0 state:

$$|\psi(t)\rangle = e^{-iMt} \left[\cos\left(\frac{1}{2}\Delta mt\right) |\bar{B}^0\rangle + ie^{2i\beta} \sin\left(\frac{1}{2}\Delta mt\right) |B^0\rangle \right]$$

- Consider decay of a CP eigenstate f , with decay amplitudes A for $\bar{B}^0 \rightarrow f$ and \bar{A} for $B^0 \rightarrow f$

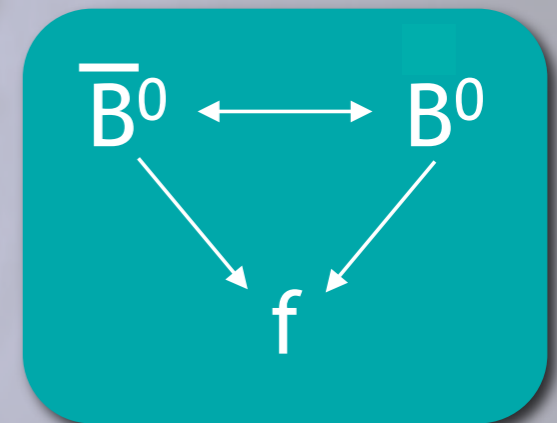

- Amplitude for this decay at time $t>0$:

$$\mathcal{A}_{\bar{B}^0}(t) = e^{-iMt} \left[A \cos\left(\frac{1}{2}\Delta mt\right) + i\bar{A} e^{2i\beta} \sin\left(\frac{1}{2}\Delta mt\right) \right]$$

direct decay

indirect decay via mixing

CP violation in interference of mixing and decay

- Time dependence of decay rate:

$$\begin{aligned}\Gamma_{\bar{B}^0 \rightarrow f}(t) &\propto |A|^2 \cos^2 \frac{\Delta mt}{2} + |\bar{A}|^2 \sin^2 \frac{\Delta mt}{2} - \text{Im}(A^* \bar{A} e^{2i\beta}) \sin \Delta mt \\ &\propto 1 + \frac{|A|^2 - |\bar{A}|^2}{|A|^2 + |\bar{A}|^2} \cos \Delta mt - \frac{2\text{Im}(A^* \bar{A} e^{2i\beta})}{|A|^2 + |\bar{A}|^2} \sin \Delta mt\end{aligned}$$

- Rate for CP-conjugate process $B^0 \rightarrow \bar{f}$ given by same expression with $A \leftrightarrow \bar{A}$ and $\beta \rightarrow -\beta$

CP violation in interference of mixing and decay

- Time-dependent CP asymmetry:

$$A_{\text{CP}}(t) \equiv \frac{\Gamma_{\bar{B}^0 \rightarrow f}(t) - \Gamma_{B^0 \rightarrow f}(t)}{\Gamma_{\bar{B}^0 \rightarrow f}(t) + \Gamma_{B^0 \rightarrow f}(t)} = \mathcal{C} \cos(\Delta m t) - \mathcal{S} \sin(\Delta m t)$$

$$\frac{|A|^2 - |\bar{A}|^2}{|A|^2 + |\bar{A}|^2}$$

(direct CP asymmetry)

$$\frac{2\text{Im}(A^* \bar{A} e^{2i\beta})}{|A|^2 + |\bar{A}|^2}$$

- Special case: decay amplitude dominated by a single partial amplitude with weak phase φ_A

$$\Rightarrow \quad \mathcal{C} = 0 \quad \text{and} \quad \mathcal{S} = \sin[2(\beta - \varphi_A)]$$

CP violation in interference of mixing and decay

- Allows determination of a weak phase (almost) free of hadronic uncertainties!
- 2 possibilities in SM:

$$\varphi_A = 0 \Rightarrow \mathcal{S} = \sin(2\beta)$$

(e.g. $B \rightarrow J/\psi K_S, \phi K_S$)

$$\varphi_A = -\gamma \Rightarrow \mathcal{S} = \sin[2(\beta + \gamma)] = -\sin(2\alpha)$$

(e.g. $B \rightarrow \pi\pi, \rho\rho$)

- Comparing $\sin 2\beta$ values extracted from tree-dominated vs. loop-dominated processes is a sensitive probe for **New Physics**

CP violation in interference of mixing and decay

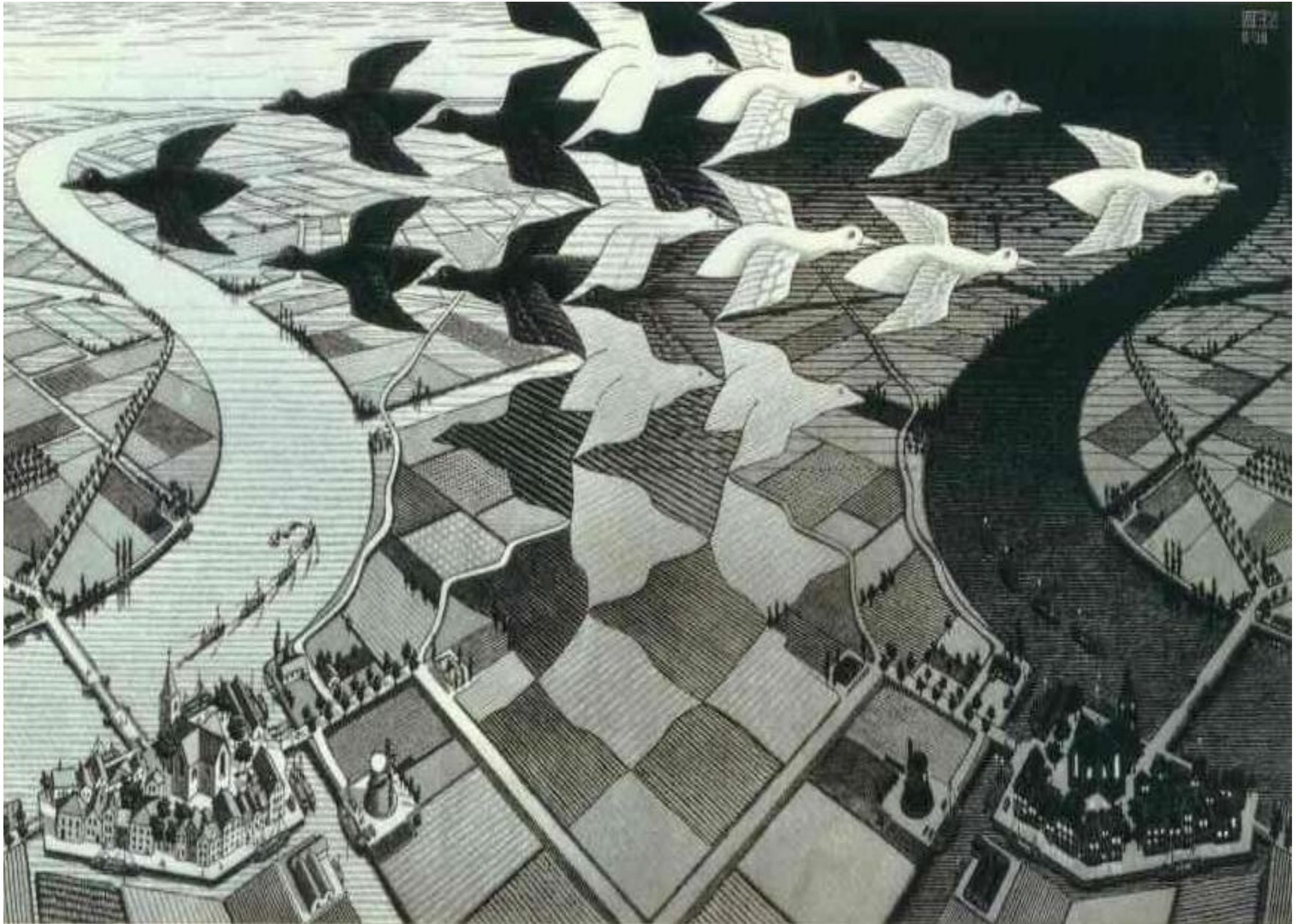

CP violation in interference of mixing and decay

- “Golden” decay
 $B \rightarrow J/\psi K_S$:

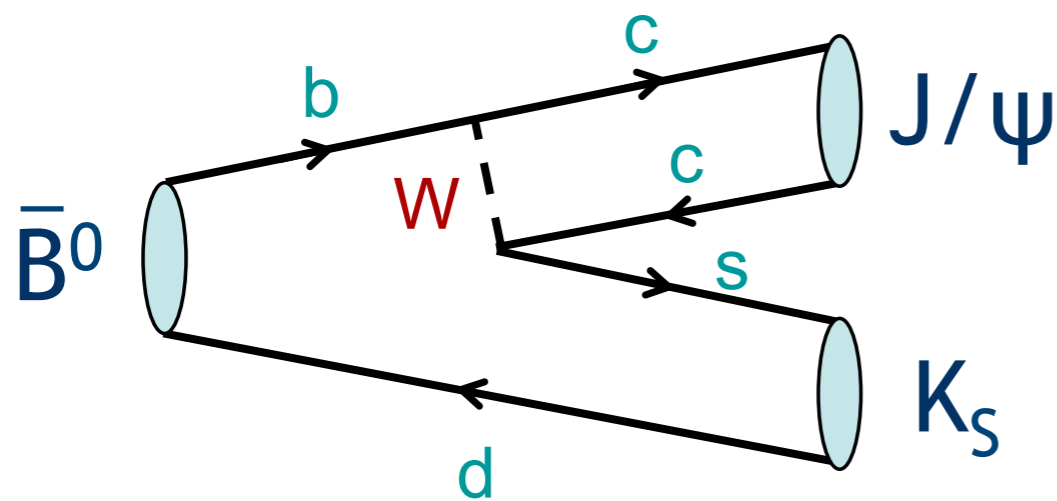

- Amplitude is real to very good approximation, $\varphi_A = 0$

- CP asymmetry $S(f) = \sin 2\beta$ determines CP-violating phase β without knowledge of decay amplitude!
- Theoretical uncertainty only $\sim 1\%$
- Very precise measurement of an angle of the unitarity triangle:

$$\sin 2\beta = 0.691 \pm 0.020$$

A very precise constraint on the unitarity triangle

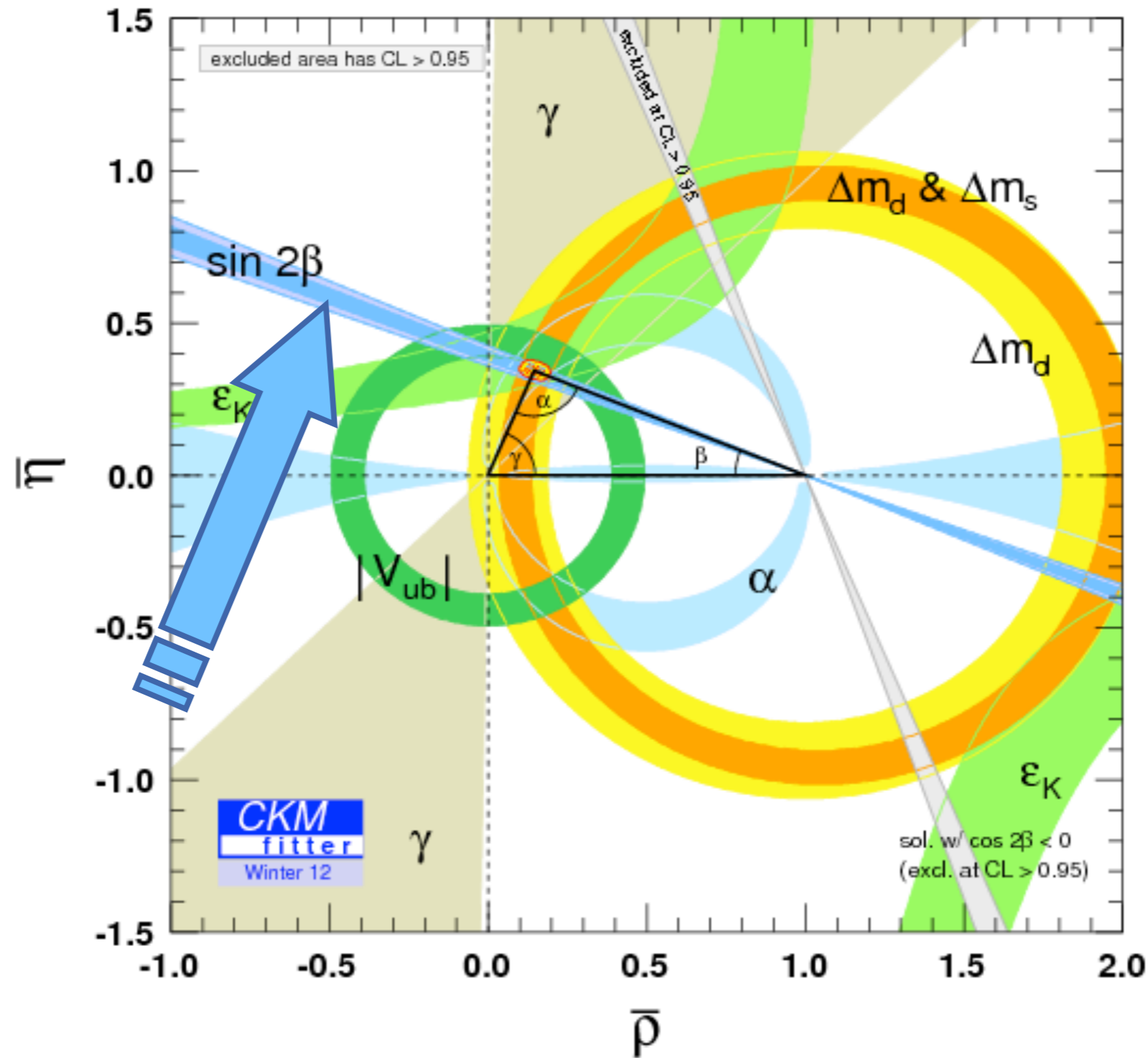

sin2β from tree- and loop-dominated processes

$$\sin(2\beta^{\text{eff}}) \equiv \sin(2\phi_1^{\text{eff}})$$

HFAG
Moriond 2012
PRELIMINARY

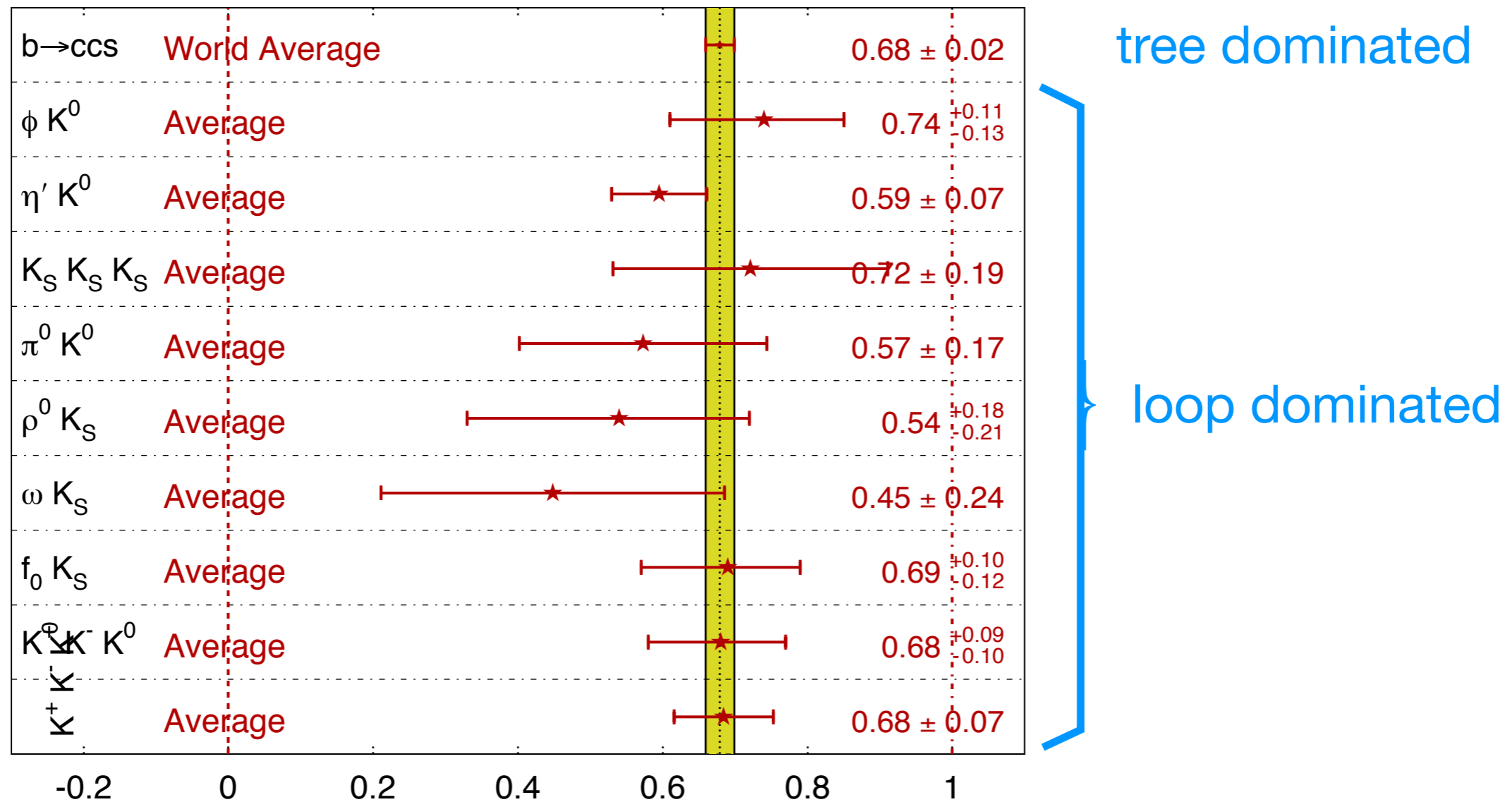

No hint yet for New Physics !

Indirect searches for New Physics

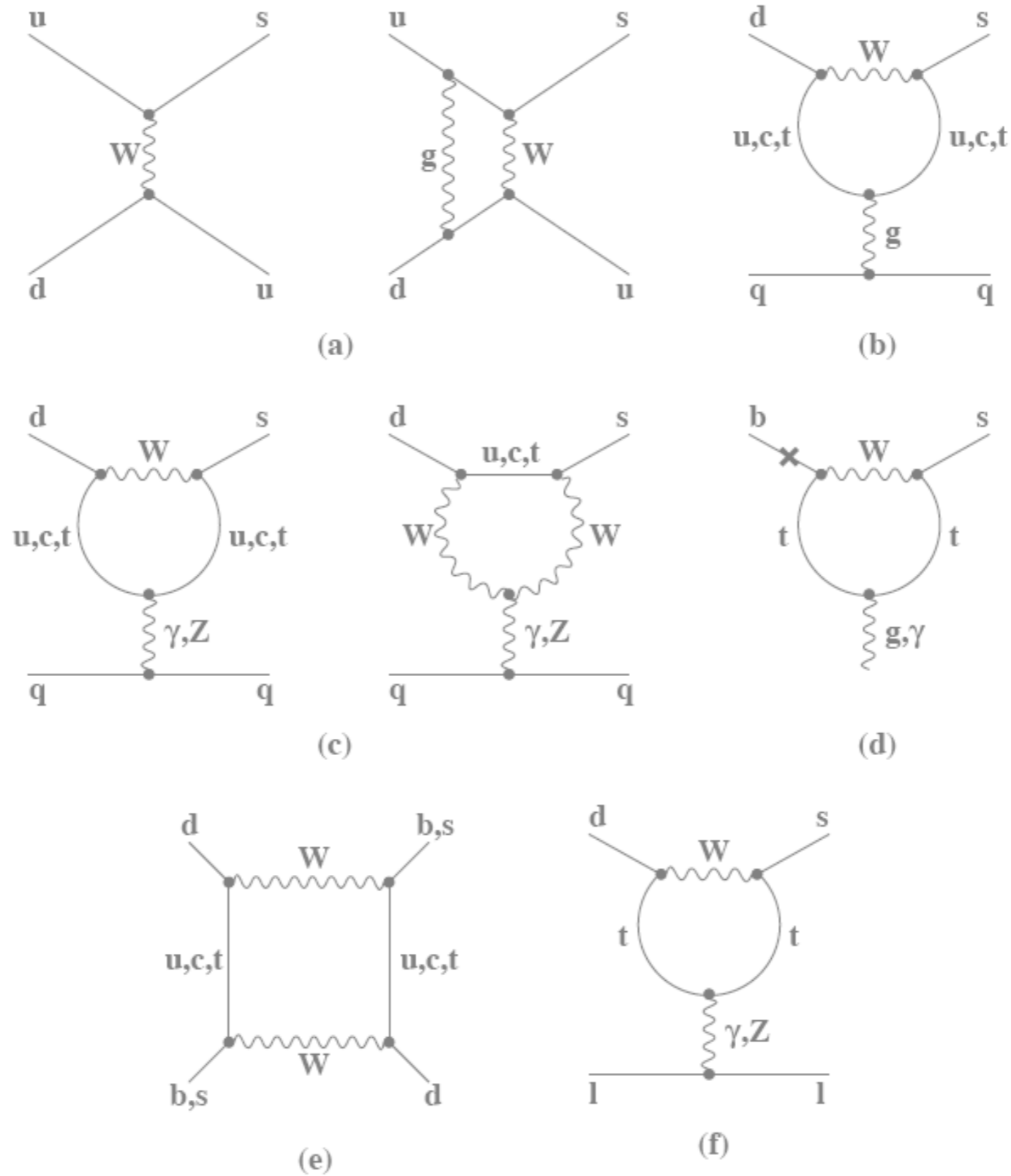

Effective field theory (a first encounter)

- At low energies, the exchange of heavy, virtual particles ($M \gg E$) leads to local effective interactions

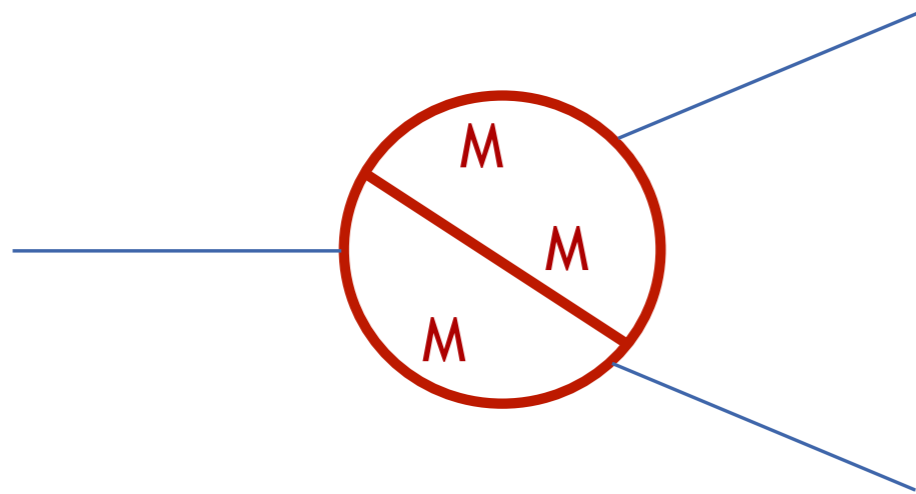

exchange of heavy, virtual particles
between light SM particles

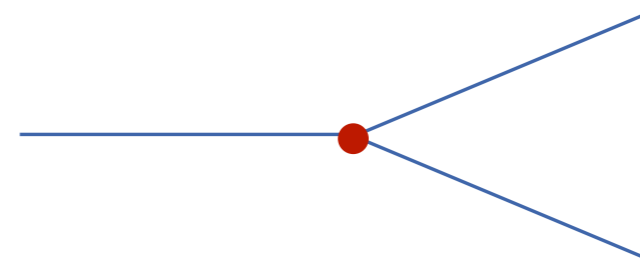

induced, effective local interactions
at low energies

- Effective field theory offers systematic description of effects of modes with large virtualities through an expansion in local operators

W exchange at low energy (Fermi theory)

- Fermi theory of weak interactions describes W-boson exchange in terms of local 4-fermion couplings
- Consider:

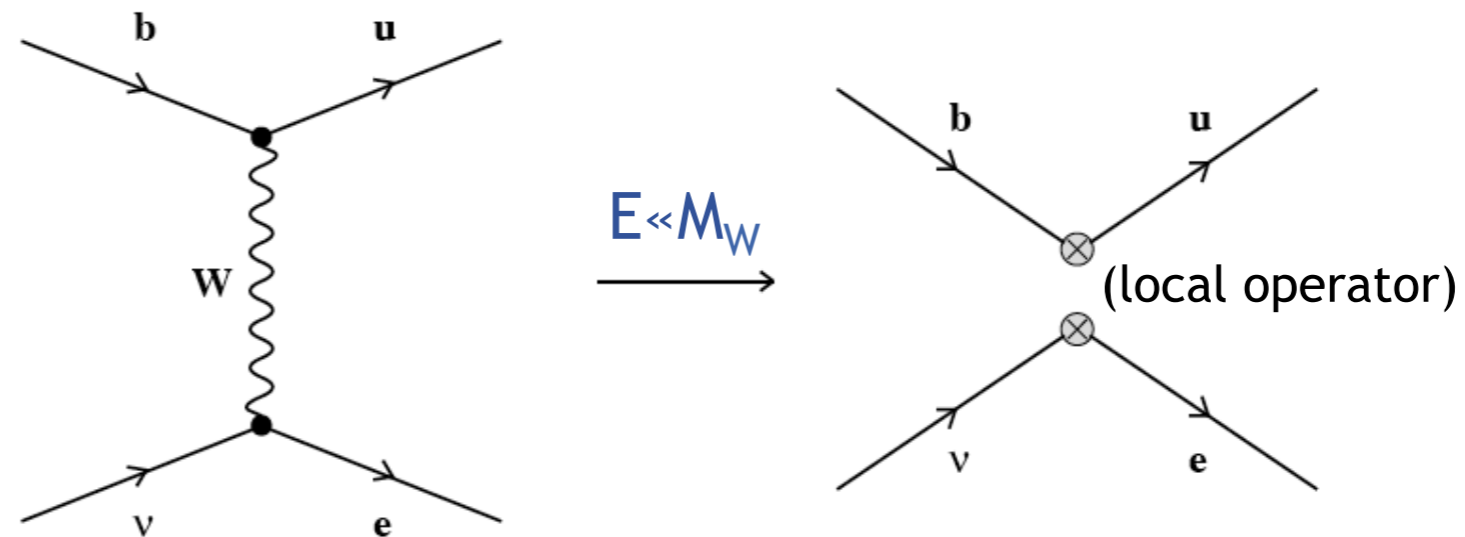

- Fermi constant: $G_F/\sqrt{2} = g_2^2/8M_W^2$
 - determines scale of weak interactions

W exchange at low energy (Fermi theory)

- Semileptonic decay: QCD corrections influence both graphs in same way
- Resulting “effective” interaction for $E \ll M_W$:

$$\mathcal{L}_{\text{eff}} = -\frac{4G_F}{\sqrt{2}} V_{ub} C_1(\mu) \bar{e}_L \gamma_\mu \nu_L \bar{u}_L \gamma^\mu b_L$$

\swarrow
 $C_1=1$

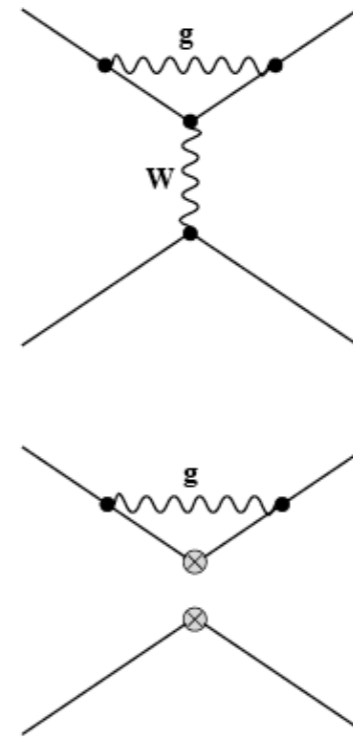

- Scaling $1/M_W^2$ for $d=6$ operators explains weakness of “weak” interactions

W exchange at low energy (Fermi theory)

- W exchange between four different quark fields (nonleptonic decays):

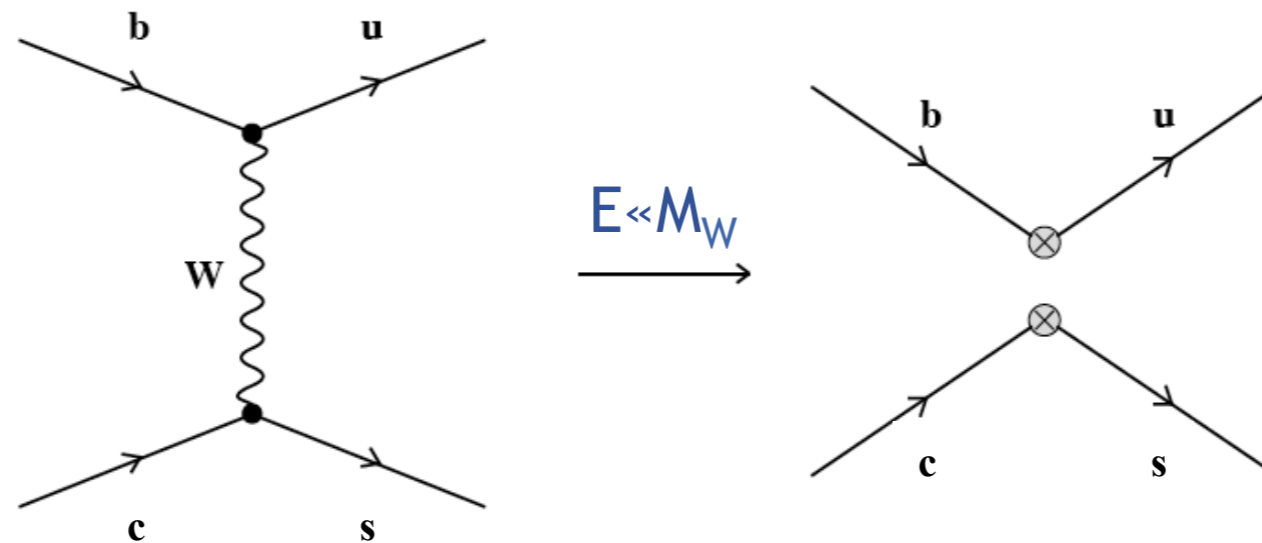

- At tree level, analogous treatment as before

W exchange at low energy (Fermi theory)

- Complications for loop graphs:

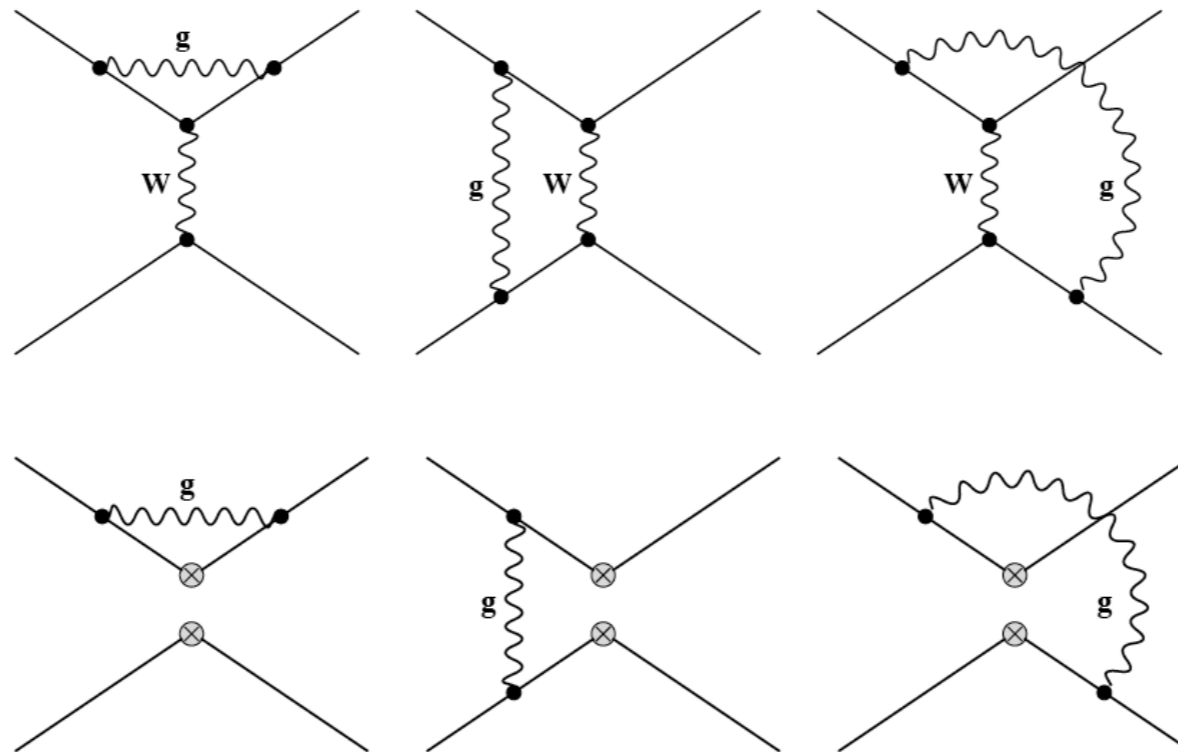

- Naive Taylor expansion of W-boson propagator no longer justified!

W exchange at low energy (Fermi theory)

- Problem with large loop momenta:

$$\int d^D p \frac{1}{M_W^2 - p^2} f(p) \neq \frac{1}{M_W^2} \int d^D p \left(1 + \frac{p^2}{M_W^2} + \dots \right) f(p)$$

- But no differences at low loop momenta!
- Effect can be calculated and corrected for using perturbation theory, since effective coupling $\alpha_s(M_W)$ is small

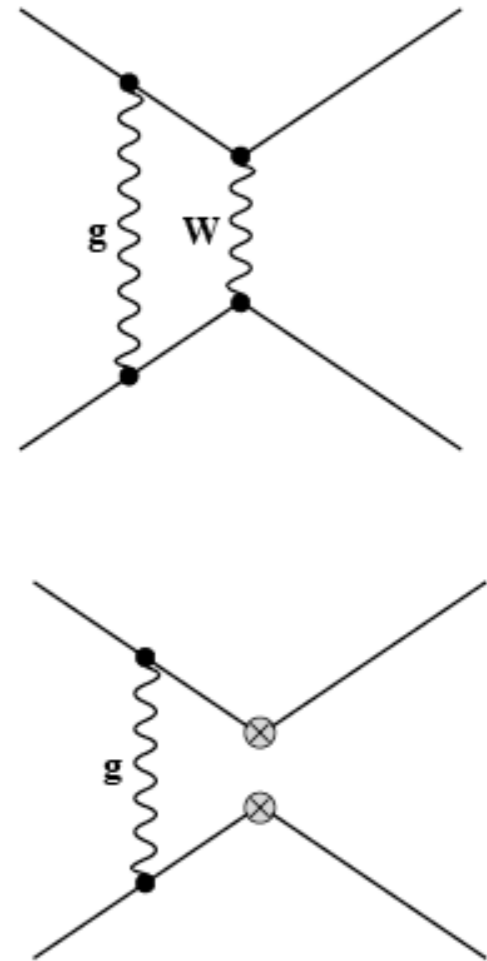

W exchange at low energy (Fermi theory)

- Resulting effective interaction:

$$\mathcal{L}_{\text{eff}} = -\frac{4G_F}{\sqrt{2}} V_{cs}^* V_{ub} \left[C_1(\mu) \bar{s}_L^j \gamma_\mu c_L^j \bar{u}_L^i \gamma^\mu b_L^i + C_2(\mu) \bar{s}_L^i \gamma_\mu c_L^j \bar{u}_L^j \gamma^\mu b_L^i \right]$$

with Wilson coefficients:

$$C_1(\mu) = 1 + \frac{3}{N_c} \frac{\alpha_s(\mu)}{4\pi} \left(\ln \frac{M_W^2}{\mu^2} - \frac{11}{6} \right) + O(\alpha_s^2)$$

$$C_2(\mu) = -3 \frac{\alpha_s(\mu)}{4\pi} \left(\ln \frac{M_W^2}{\mu^2} - \frac{11}{6} \right) + O(\alpha_s^2).$$

→ accounts for effects of hard gluons ($p \sim M_W$)

Main idea of effective field theory

- Separation of short- and long-distance effects; schematically:

$$\int_{-p^2}^{M_W^2} \frac{dk^2}{k^2} = \int_{\mu^2}^{M_W^2} \frac{dk^2}{k^2} + \int_{-p^2}^{\mu^2} \frac{dk^2}{k^2}$$

- Short-distance effects ($p \sim M_W$) are perturbatively calculable
- Long-distance effects must be treated using nonperturbative methods
- Dependence on arbitrary separation scale μ controlled by RG equations

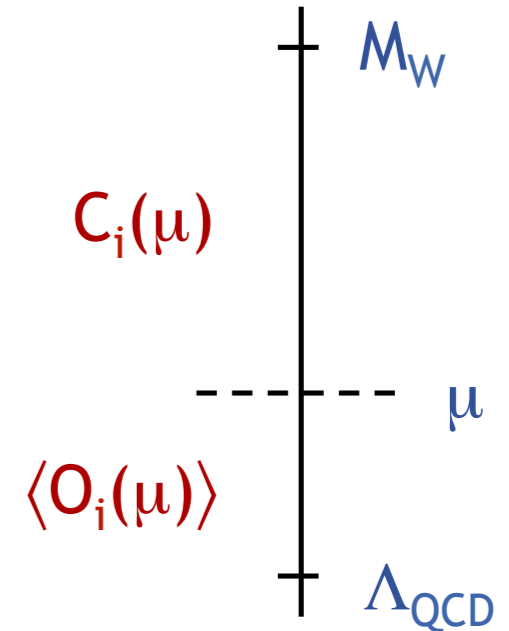

Main idea of effective field theory

- Why useful?
- Any sensitivity to high scales (including to physics beyond the Standard Model) can be treated using perturbative methods:

$$C_i(\mu) = C_i^{SM}(M_W, m_t, \mu) + C_i^{NP}(M_{NP}, g_{NP}, \mu)$$

- Nonperturbative methods (operator product expansion, lattice gauge theory, ...) usually only work at low scales (typically $\mu \sim \text{few GeV}$)

FCNC processes

- While generation-changing couplings of W bosons to quarks exist, flavor-changing neutral currents such as

$$b \rightarrow s\gamma, \quad b \rightarrow sZ^0, \quad b \rightarrow s\nu\bar{\nu}, \quad b \rightarrow s d\bar{d}, \quad b\bar{d} \rightarrow d\bar{b}, \quad \text{etc.}$$

(and others, also for light quarks)

do not exist as elementary vertices in the Standard Model (GIM mechanism)

FCNC processes

- But such processes can be induced at loop level, e.g.:

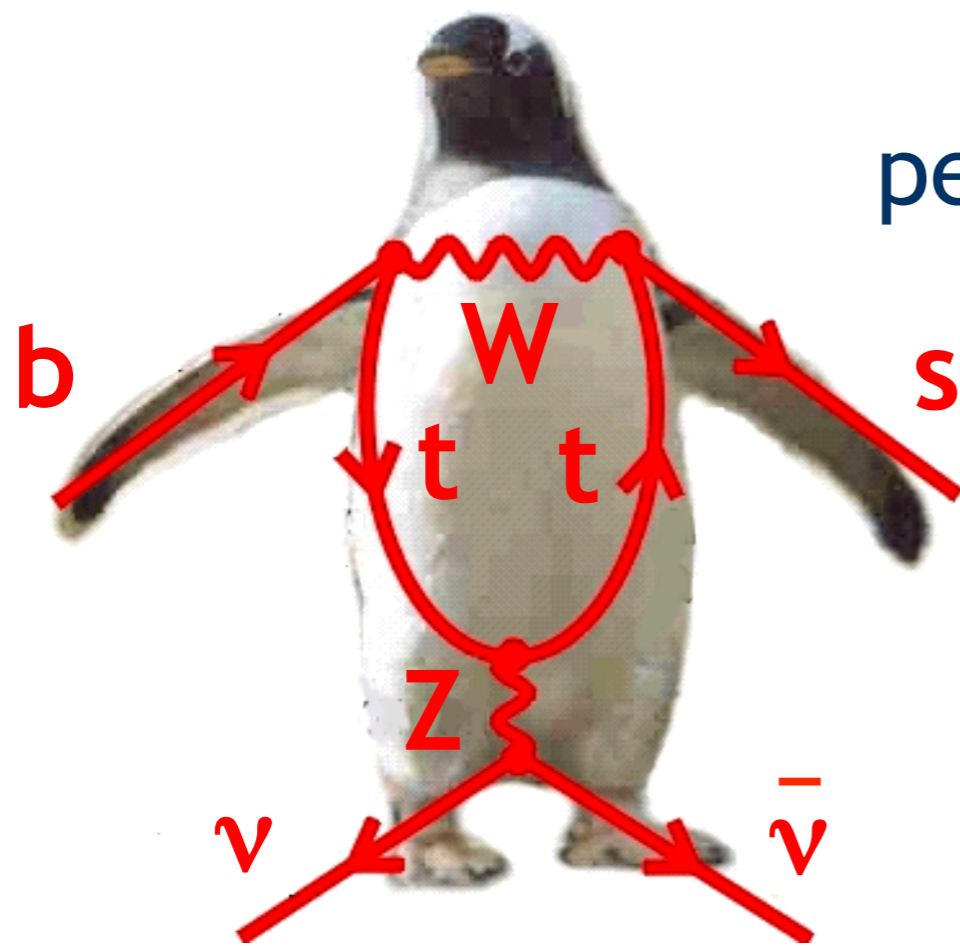

penguin diagram

loop-induced
decay $b \rightarrow s \nu \bar{\nu}$

FCNC processes

- Effective interaction at low energies
($E \ll M_W, M_Z, m_t$):

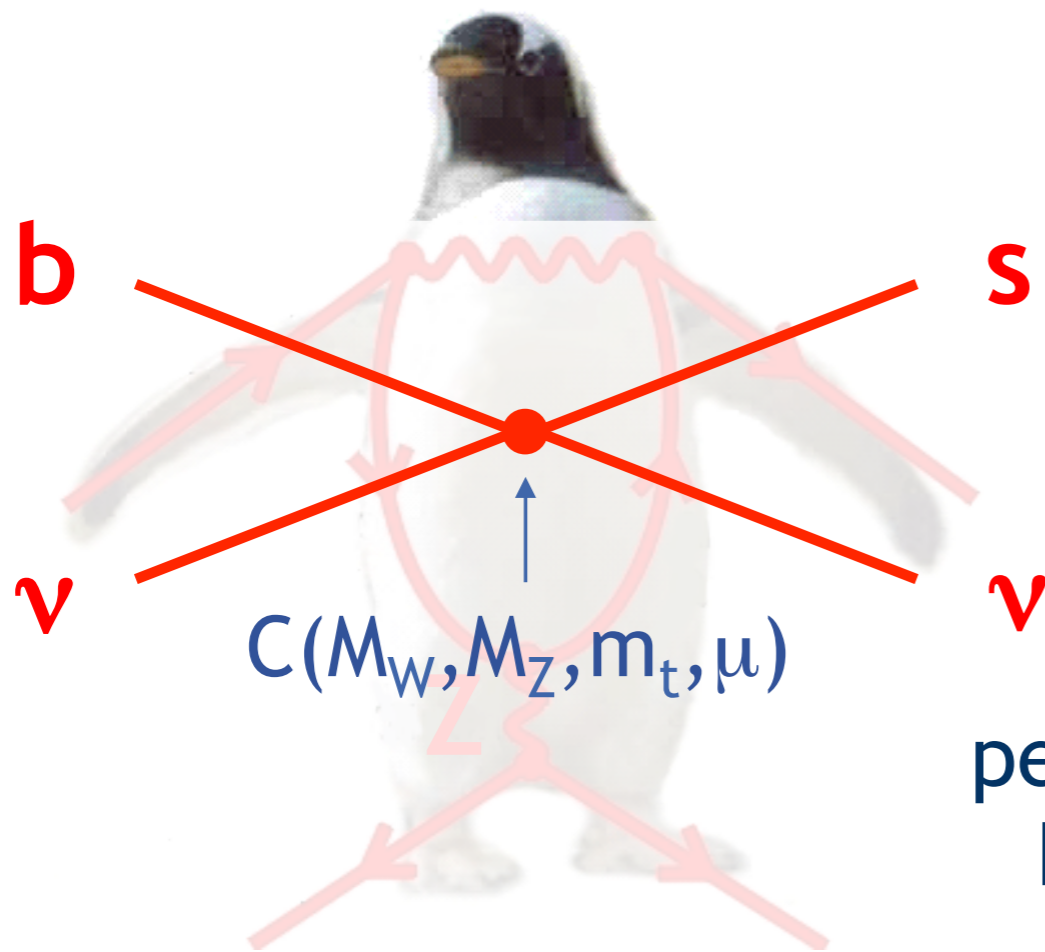

penguin diagram approximated
by local 4-fermion operator

FCNC processes

- Detailed analysis (**penguin autopsy**) exhibits that GIM mechanism is “incomplete” in this case:

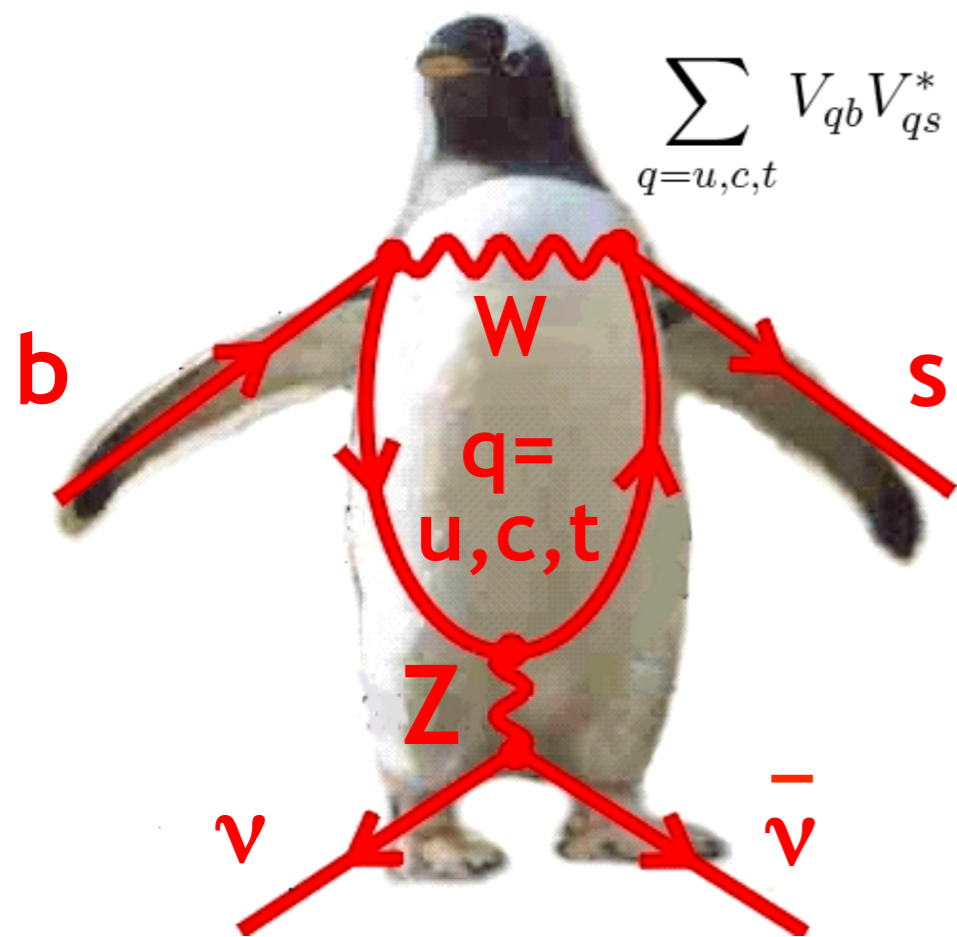

$$\sum_{q=u,c,t} V_{qb} V_{qs}^* f\left(\frac{m_q^2}{M_W^2}, \dots\right) = V_{tb} V_{ts}^* \left[f\left(\frac{m_t^2}{M_W^2}, \dots\right) - f\left(\frac{m_u^2}{M_W^2}, \dots\right) \right] + V_{cb} V_{cs}^* \left[f\left(\frac{m_c^2}{M_W^2}, \dots\right) - f\left(\frac{m_u^2}{M_W^2}, \dots\right) \right]$$

Unitarity relation:

$$V_{tb} V_{ts}^* + V_{cb} V_{cs}^* + V_{ub} V_{us}^* = 0$$

→ residual effect due to nontrivial mass dependence, often $\propto (m_t/M_W)^2$ or $\ln(m_t/\mu)$

FCNC processes

- Rich structure of couplings of Z^0, g, γ lead to a plethora of effective local $d=6$ operators
- Consider, e.g., decays of type $b \rightarrow s+X$ (or $b \rightarrow d+X$, $s \rightarrow d+X$), where X is flavor neutral:

$$\mathcal{H}_{\text{eff}} = \frac{G_F}{\sqrt{2}} \left[\sum_{q=u,c} V_{qb} V_{qs}^* \left(C_1 Q_1^{(q)} + C_2 Q_2^{(q)} \right) - V_{tb} V_{ts}^* \sum_{i=3, \dots, 10, 7\gamma, 8g} C_i Q_i \right]$$

W-boson exchange

penguin and box graphs

Operator basis

- Current-current operators (W exchange):

$$Q_1^{(p)} = (\bar{s}_i p_i)_{V-A} (\bar{p}_j b_j)_{V-A}$$

$$Q_2^{(p)} = (\bar{s}_i p_j)_{V-A} (\bar{p}_j b_i)_{V-A}$$

$$(\bar{q}_1 q_2)_{V\pm A} \equiv \bar{q}_1 \gamma^\mu (1 \pm \gamma_5) q_2$$

- Results analogous to earlier discussion):

$$C_1(M_W) = 1 - \frac{11}{6} \frac{\alpha_s(M_W)}{4\pi}$$

$$C_2(M_W) = \frac{11}{2} \frac{\alpha_s(M_W)}{4\pi},$$

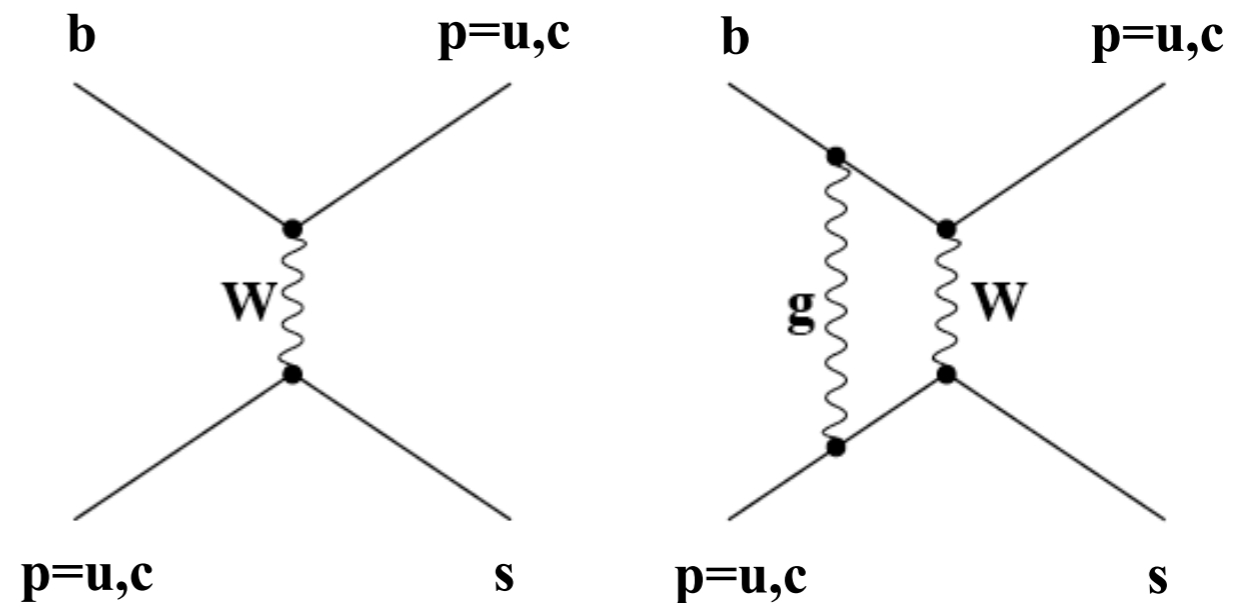

← results quoted at $\mu=M_W$ for simplicity

Operator basis

- QCD penguin operators:

$$Q_3 = (\bar{s}_i b_i)_{V-A} \sum_{q=u,d,s,c,b} (\bar{q}_j q_j)_{V-A}$$

$$Q_4 = (\bar{s}_i b_j)_{V-A} \sum_{q=u,d,s,c,b} (\bar{q}_j q_i)_{V-A}$$

$$Q_5 = (\bar{s}_i b_i)_{V-A} \sum_{q=u,d,s,c,b} (\bar{q}_j q_j)_{V+A}$$

$$Q_6 = (\bar{s}_i b_j)_{V-A} \sum_{q=u,d,s,c,b} (\bar{q}_j q_i)_{V+A}$$

- Results:

$$C_3(M_W) = C_5(M_W) = -\frac{1}{6} \tilde{E}_0 \left(\frac{m_t^2}{M_W^2} \right) \frac{\alpha_s(M_W)}{4\pi}$$

$$C_4(M_W) = C_6(M_W) = \frac{1}{2} \tilde{E}_0 \left(\frac{m_t^2}{M_W^2} \right) \frac{\alpha_s(M_W)}{4\pi}$$

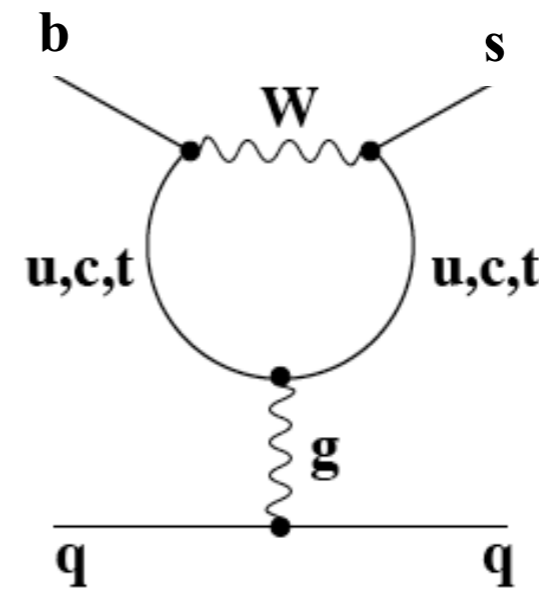

Loop function:

$$\tilde{E}_0(x) = -\frac{7}{12} + O(1/x)$$

Operator basis

- Electroweak penguin operators:

$$Q_7 = (\bar{s}_i b_i)_{V-A} \sum_{q=u,d,s,c,b} \frac{3}{2} e_q (\bar{q}_j q_j)_{V+A}$$

$$Q_8 = (\bar{s}_i b_j)_{V-A} \sum_{q=u,d,s,c,b} \frac{3}{2} e_q (\bar{q}_j q_i)_{V+A}$$

$$Q_9 = (\bar{s}_i b_i)_{V-A} \sum_{q=u,d,s,c,b} \frac{3}{2} e_q (\bar{q}_j q_j)_{V-A}$$

$$Q_{10} = (\bar{s}_i b_j)_{V-A} \sum_{q=u,d,s,c,b} \frac{3}{2} e_q (\bar{q}_j q_i)_{V-A}$$

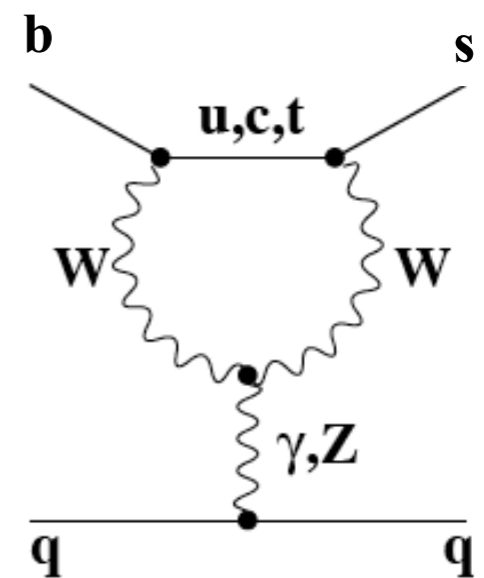
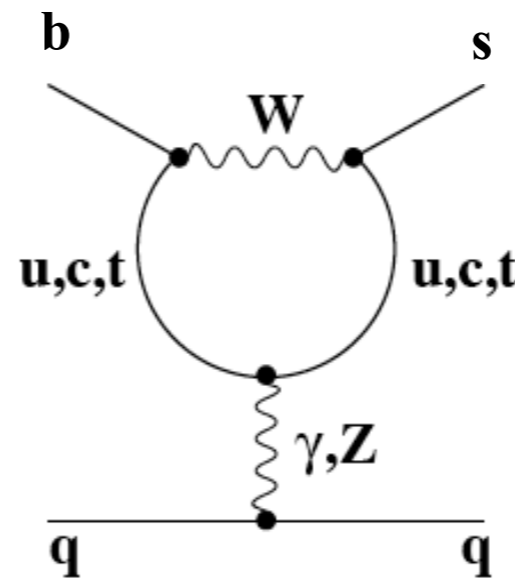

- Results:

$$C_7(M_W) = f\left(\frac{m_t^2}{M_W^2}\right) \frac{\alpha(M_W)}{6\pi}, \quad C_8(M_W) = C_{10}(M_W) = 0$$

$$C_9(M_W) = \left[f\left(\frac{m_t^2}{M_W^2}\right) + \frac{1}{\sin^2 \theta_W} g\left(\frac{m_t^2}{M_W^2}\right) \right] \frac{\alpha(M_W)}{4\pi}$$

Loop functions:

$$f(x) = \frac{x}{2} + \frac{4}{3} \ln x - \frac{125}{36} + O(1/x)$$

$$g(x) = -\frac{x}{2} - \frac{3}{2} \ln x + O(1/x)$$

Operator basis

- Dipol operators:

$$Q_{7\gamma} = -\frac{em_b}{8\pi^2} \bar{s} \sigma_{\mu\nu} (1 + \gamma_5) F^{\mu\nu} b$$

$$Q_{8g} = -\frac{g_s m_b}{8\pi^2} \bar{s} \sigma_{\mu\nu} (1 + \gamma_5) G_a^{\mu\nu} t_a b$$

- Results ($x=m_t^2/M_W^2$) :

$$C_{7\gamma}(M_W) = -\frac{1}{3} + O(1/x)$$

$$C_{8g}(M_W) = -\frac{1}{8} + O(1/x)$$

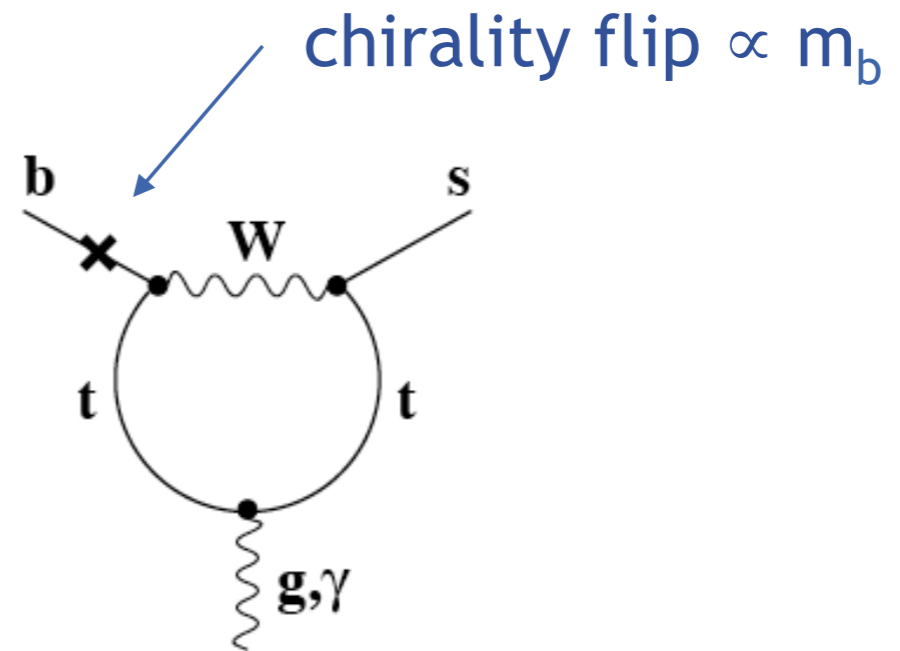

That's it !
(apart from operators containing leptons ...)

Operator basis for neutral meson mixing

- Consider finally B- \bar{B} or K- \bar{K} mixing processes mediated by transitions $b\bar{d} \rightarrow d\bar{b}$ (or $b\bar{s} \rightarrow s\bar{b}$, $s\bar{d} \rightarrow d\bar{s}$)
- Effective interaction:

$$\mathcal{L}_{\text{eff}} = G_F^2 (V_{tb} V_{td}^*)^2 F\left(\frac{m_t^2}{M_W^2}\right) (\bar{d}b)_{V-A} (\bar{d}b)_{V-A}$$

- dominant contribution ($\propto m_t^2$) due to top-quark loop
- first hint toward very heavy top quark

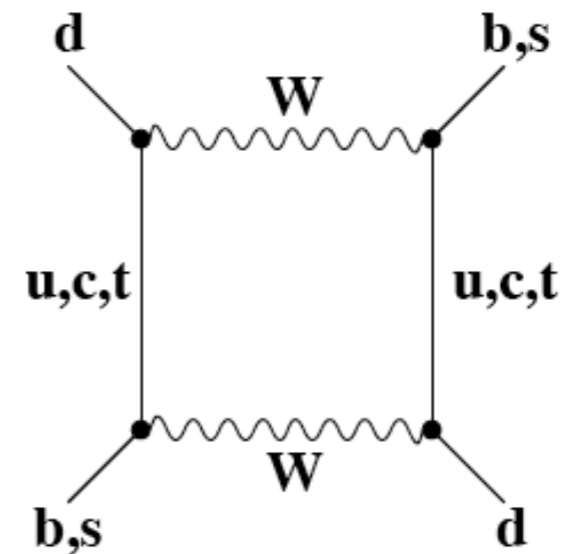

Probing New Physics in the quark flavor sector

Effective Lagrangians offer a **systematic way** to parameterize possible **New Physics contributions** in weak-interaction processes in terms of **Wilson coefficients**

The corresponding effects are **suppressed by $(g_X/\Lambda_{\text{NP}})^2$** , in analogy with $G_F \sim (g/M_W)^2$ in the Standard Model

Rare FCNC processes have **very strong, indirect sensitivity** to New Physics scales in the multi-TeV range, often outside the reach for direct production of new particles at the LHC

Flavor physics thus **complements direct searches** at LHC

Probing New Physics in the quark flavor sector

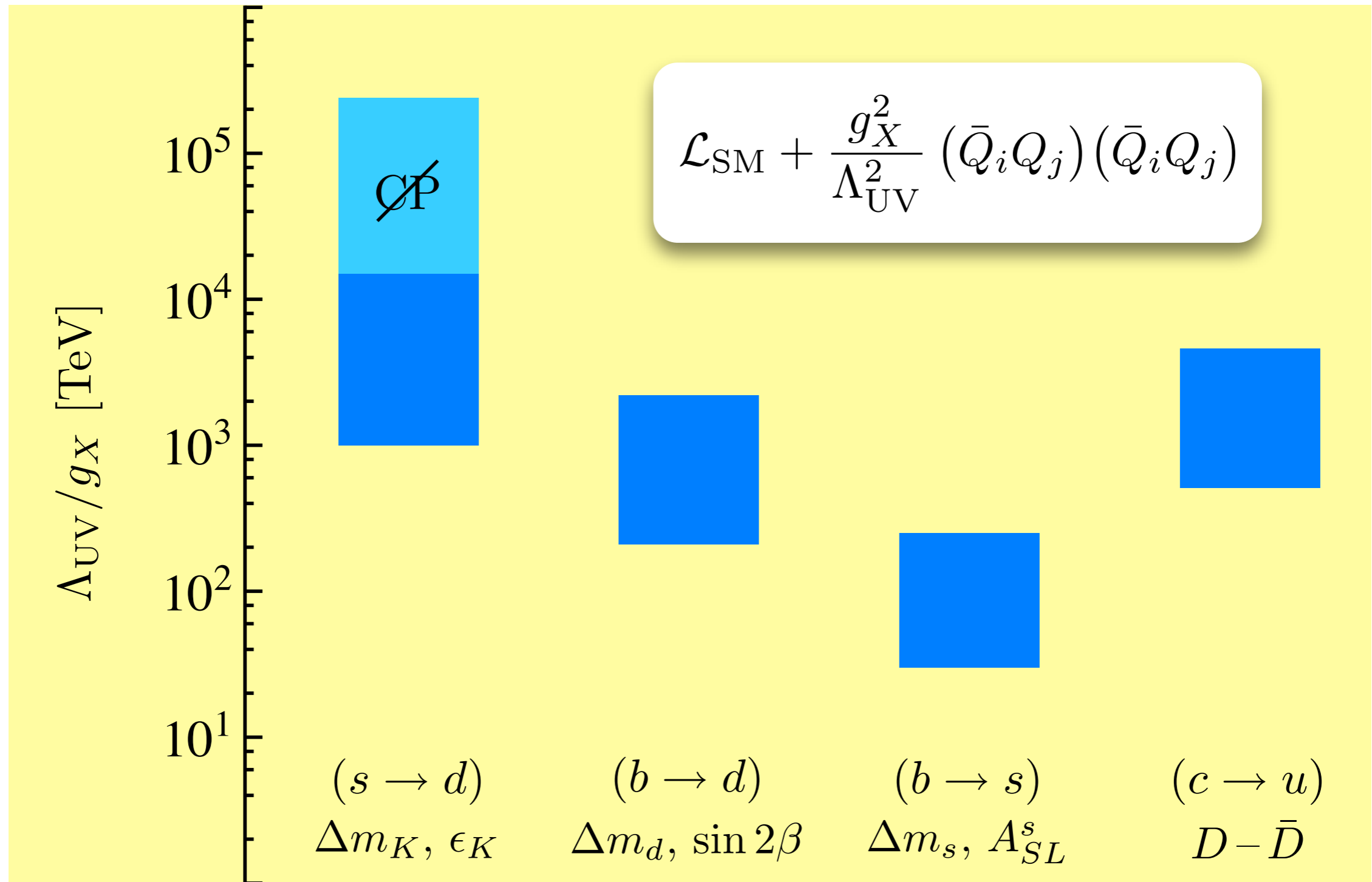

Generic bounds on New Physics scale (for $g_X \sim 1$)

Probing New Physics in the quark flavor sector

The fact that the generic New Physics scales in flavor physics are in the multi-TeV range is sometimes called the **flavor puzzle**

Either new particles are really as heavy as **10-1000 TeV**, and the hierarchy problem is solved by fine-tuning, or there must be a mechanism explaining why the flavor-changing New Physics interactions are **strongly suppressed** ($g_X \ll 1$)

The latter calls for **flavor symmetries** or an **alignment mechanism**, which correlated these couplings with the small flavor-violating parameters of the Standard Model to New

⇒ important impact on BSM model building !

Effective field theory

Lecture III: Concepts of Effective Field Theory

- Basic ideas, Wilsonian effective action
- Scale separation, integrating out high-energy modes, low-energy effective Lagrangian, dimensional analysis
- Modern view of QFTs and general principles

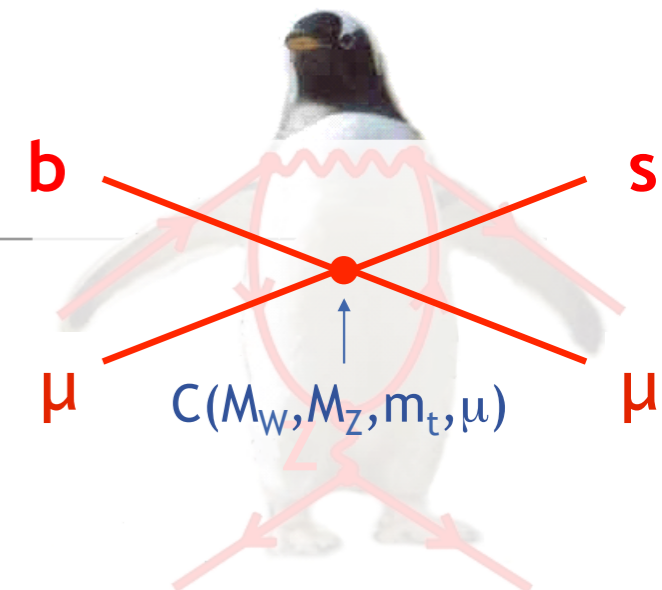

Lecture IV: Applications of Effective Field Theory

- The Standard Model as an effective field theory
- Several examples of applications beyond the Standard Model
- Interesting insights

Effective field theory

Effective field theories are a very powerful tool in quantum field theory (QFT):

- systematic formalism for the analysis of **multi-scale problems** (“Taylor expansion of Feynman graphs”)
- simplifies **practical calculations**, often makes them feasible
- particularly important in QCD, where short-distance effects are calculable perturbatively but long-distance effects are not
- provides new perspective on **renormalization**
- basis of **factorization** (i.e. scale separation) and **resummation** of large logarithmic terms

Effective field theory

Useful reviews:

- E. Witten, Nucl. Phys. B 122 (1977) 109
- S. Weinberg, Phys. Lett. B 91 (1980) 51
- L. Hall, Nucl. Phys. B 178 (1981) 75
- J. Polchinsky, hep-th/9210046
- A. Buras, hep-ph/9806471
- M. Neubert, hep-ph/0512222

Lecture III: Concepts of Effective Field Theory

Derivation of the effective Lagrangian

Consider a QFT with a characteristic (fundamental) high-energy scale M

We are interested in performing experiments at energies $E \ll M$

Step 1: Choose a cutoff $\Lambda < M$ and divide all quantum fields into high- and low-frequency components ($\omega > \Lambda$ and $\omega < \Lambda$):

$$\phi = \phi_L + \phi_H$$

Recall:

$$\phi(x) = \int \frac{d^3 k}{(2\pi)^3 2E_k} \left(a_k e^{-ik \cdot x} + a_k^\dagger e^{ik \cdot x} \right)$$

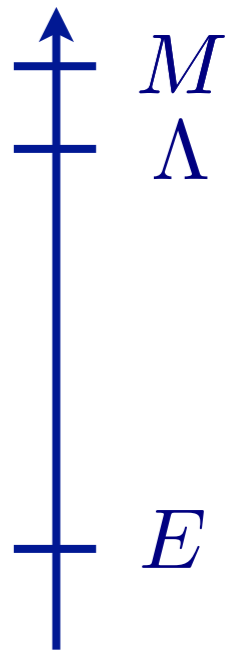

Derivation of the effective Lagrangian

Consider a QFT with a characteristic (fundamental) high-energy scale M

We are interested in performing experiments at energies $E \ll M$

Step 1: Choose a cutoff $\Lambda < M$ and divide all quantum fields into high- and low-frequency components ($\omega > \Lambda$ and $\omega < \Lambda$):

$$\phi = \phi_L + \phi_H$$

Physics (i.e. Green functions) at low energies $E \ll \Lambda$ is entirely described in terms of the fields ϕ_L ; Green functions of these fields can be derived from the generating functional:

$$Z[J_L] = \int \mathcal{D}\phi_L \mathcal{D}\phi_H e^{iS(\phi_L, \phi_H) + i \int d^D x J_L(x) \phi_L(x)}$$

$$\langle 0 | T \{ \phi_L(x_1) \dots \phi_L(x_n) \} | 0 \rangle = \frac{1}{Z[0]} \left(-i \frac{\delta}{\delta J_L(x_1)} \right) \dots \left(-i \frac{\delta}{\delta J_L(x_n)} \right) Z[J_L] \Big|_{J_L=0}$$

Derivation of the effective Lagrangian

Step 2: Since the high-frequency fields ϕ_H do not appear in the generating functional, we can “**integrate them out**” in the path integral:

$$Z[J_L] \equiv \int \mathcal{D}\phi_L e^{iS_\Lambda(\phi_L) + i \int d^D x J_L(x) \phi_L(x)}$$

where

$$e^{iS_\Lambda(\phi_L)} = \int \mathcal{D}\phi_H e^{iS(\phi_L, \phi_H)}$$

and $S_\Lambda(\phi_L)$ is called the **Wilsonian effective action**

Dependence on the cutoff Λ enters via the condition on the frequencies of the fields

Derivation of the effective Lagrangian

Step 3: Effective action is **non-local** on the scale $\Delta t \sim 1/\omega$, corresponding to the propagation of high-energy modes that have been removed from the Lagrangian

Since the remaining fields have energies $\omega < \Lambda$, the non-local effective action can be expanded in an **infinite series of local operators**:

$$S_\Lambda(\phi_L) = \int d^D x \mathcal{L}_\Lambda^{\text{eff}}(x)$$

where:

$$\mathcal{L}_\Lambda^{\text{eff}}(x) = \sum_i g_i Q_i(\phi_L(x))$$

coupling constants
(Wilson coefficients)

local operators built out of
fields ϕ_L and their derivatives

Dimensional analysis

Does a Lagrangian consisting of an infinite number of interactions and hence an infinite number of (renormalized) coupling constants give any predictive power?

- Not if one adopts an old-fashioned view about renormalization and renormalizable QFTs
- But not all is lost...

We can use **naive dimensional analysis** to estimate the size of individual terms in the infinite sum to any given matrix element

Dimensional analysis

As is common practice in particle physics, we adopt units where $\hbar = c = 1$, such that $[m] = [E] = [p] = [x^{-1}] = [t^{-1}]$ are all measured in the same units (mass units)

Denote by $[g_i] = -\gamma_i$ the mass dimension of the coupling constants in the effective Lagrangian

Since by assumption the theory has only a single fundamental scale M , it follows that:

$$g_i = C_i M^{-\gamma_i}$$

where by **naturalness** we expect that $C_i = O(1)$

Dimensional analysis

At low energy, it follows that the contribution of a given term $g_i Q_i$ to an observable (which for simplicity we assume to be dimensionless) scales like:

$$C_i \left(\frac{E}{M} \right)^{\gamma_i} = \begin{cases} O(1); & \text{if } \gamma_i = 0 \\ \ll 1; & \text{if } \gamma_i > 0 \\ \gg 1; & \text{if } \gamma_i < 0 \end{cases}$$

Therefore, only operators with $\gamma_i \leq 0$ are important for $E \ll M$

This is what makes the effective Lagrangian useful !

Depending on the precision goal, one can truncate the infinite sum over terms by only retaining operators whose γ_i value is smaller than a certain value

Dimensional analysis

Since the Lagrangian has mass dimension $D = \text{dimensionality of spacetime}$ (the action is dimensionless), it follows that

$$\delta_i = [Q_i] = D + \gamma_i$$

Hence we can summarize:

Dimension	Importance for $E \rightarrow 0$	Terminology
$\delta_i < D, \gamma_i < 0$	grows	relevant operators (super-renormalizable)
$\delta_i = D, \gamma_i = 0$	constant	marginal operators (renormalizable)
$\delta_i > D, \gamma_i > 0$	falls	irrelevant operators (non-renormalizable)

Only a **finite number** of relevant and marginal operators exist !

Dimensional analysis

Comments:

Dimension	Importance for $E \rightarrow 0$	Terminology
$\delta_i < D, \gamma_i < 0$	grows	relevant operators (super-renormalizable)
$\delta_i = D, \gamma_i = 0$	constant	marginal operators (renormalizable)
$\delta_i > D, \gamma_i > 0$	falls	irrelevant operators (non-renormalizable)

- “**relevant**” operators are usually unimportant, since they are forbidden by some symmetry (otherwise they give rise to a hierarchy problem)
- “**marginal**” operators are all there is in renormalizable QFTs
- “**irrelevant**” operators are the most interesting ones, since they tell us something about the fundamental scale M

Example: ϕ^4 - theory at weak coupling

Use the free Lagrangian to derive the mass dimension of all fields and couplings, assuming the theory is weakly coupled:

$$S = \int d^D x \left(\frac{1}{2} \partial_\mu \phi \partial^\mu \phi - \frac{m^2}{2} \phi^2 - \frac{\lambda}{4!} \phi^4 \right)$$

In D dimensions, it follows that:

$$[\phi] = \frac{D}{2} - 1, \quad [m] = 1, \quad [\lambda] = 4 - D$$

Hence:

- The mass term is a relevant operator
- The interaction term is marginal in $D=4$ (relevant in $D<4$)

Example: ϕ^4 - theory at weak coupling

Use the free Lagrangian to derive the mass dimension of all fields and couplings, assuming the theory is weakly coupled:

$$S = \int d^D x \left(\frac{1}{2} \partial_\mu \phi \partial^\mu \phi - \frac{m^2}{2} \phi^2 - \frac{\lambda}{4!} \phi^4 \right)$$

In D dimensions, it follows that:

$$[\phi] = \frac{D}{2} - 1, \quad [m] = 1, \quad [\lambda] = 4 - D$$

Hence:

- An operator containing n_1 fields ϕ and n_2 derivatives has dimension:

$$\delta_i = n_1 \left(\frac{D}{2} - 1 \right) + n_2, \quad \gamma_i = (n_1 - 2) \left(\frac{D}{2} - 1 \right) + (n_2 - 2)$$

- For $D > 2$, adding fields or derivatives increases the dimension !

Comments

Examples of effective field theories:

High-energy theory	Fundamental scale	Low-energy theory
Standard Model	$M_W \sim 80 \text{ GeV}$	Fermi theory
GUT	$M_{\text{GUT}} \sim 10^{16} \text{ GeV}$	Standard Model
String theory	$M_S \sim 10^{18} \text{ GeV}$	QFT
11-dim. M theory	...	String theory
...
QCD	$m_b \sim 5 \text{ GeV}$	HQET, NRQCD
	$M_{\text{ChSM}} \sim 1 \text{ GeV}$	ChPT

- SM and GUTs are perturbative QFTs
- Fermi theory contains only irrelevant operators (4 fermions)
- String/M theory: fundamental theory is non-local and even spacetime breaks down at short distances

Comments

Examples of effective field theories:

High-energy theory	Fundamental scale	Low-energy theory
Standard Model	$M_W \sim 80 \text{ GeV}$	Fermi theory
GUT	$M_{\text{GUT}} \sim 10^{16} \text{ GeV}$	Standard Model
String theory	$M_S \sim 10^{18} \text{ GeV}$	QFT
11-dim. M theory	...	String theory
...
QCD	$m_b \sim 5 \text{ GeV}$	HQET, NRQCD
	$M_{\text{ChSM}} \sim 1 \text{ GeV}$	ChPT

- QCD at low energy: example with strong coupling, where the relevant degrees of freedom at low energy (hadrons) are different from the degrees of freedom of QCD
- Low-energy theory is strongly coupled, yet ChPT is useful

Running couplings / Wilson coefficients

Often the fields ϕ_H correspond to heavy particles, whose effects become unimportant at low energies

But the frequency decomposition implies that **high-energy excitations of massless particles** (such as gauge bosons) are also integrated out from the low-energy effective theory

Consider now the situation where we lower the cutoff Λ without crossing the threshold for a heavy particle that could be integrated out:

- the structure of the operators Q_i in the effective Lagrangian remains the same
- hence, the effect of lowering the cutoff must be entirely absorbed into the values of the coupling constants g_i

Follows that $g_i = g_i(\Lambda)$ are **running**, Λ -dependent parameters !

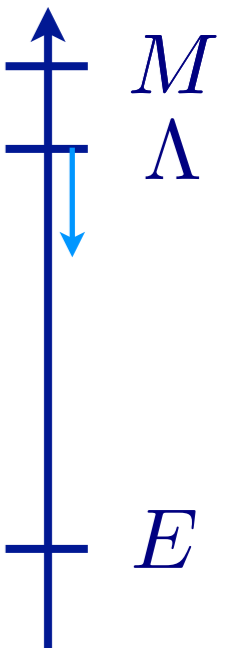

Modern quantum field theory

“Theorem of modesty”:

- no QFT ever is complete on all length and energy scales
- all QFTs are low-energy effective theories valid in some energy range, up to some cutoff Λ

Giving up renormalizability as a construction criterion for “decent” QFTs:

- at low energy, any effective theory will automatically reduce to a “renormalizable” QFT, meaning that “non-renormalizable” interactions give rise to small contributions $\sim (E/M)^n$
- this does not make renormalization irrelevant, but it provides a different point of view (Wilsonian picture of the RG)

Modern quantum field theory

Forget the folklore about “cancellations of infinities”

Get used to more physical viewpoint that:

- low-energy physics depends on the **short-distance dynamics** of the fundamental theory only through a small number of **relevant and marginal couplings**, and possibly through some irrelevant couplings if our measurements are sufficiently precise
- this finite number of couplings can be renormalized (i.e., infinities can be removed consistently) using a finite number of experimental data
- textbook criterion of “renormalizability” is automatically fulfilled (approximately) by any effective field theory

Modern quantum field theory

Forget the folklore about “cancellations of infinities”

Get used to more physical viewpoint that:

- contrary to the old paradigm of strictly forbidding non-renormalizable interactions, we always expect them to be present and give rise to small effects, which may or may not be observable at a given level of accuracy
- this provides an “**indirect way**” to search for hints of physics beyond the (current) Standard Model:

low-energy, high-precision measurements

Modern quantum field theory

Instead, relevant (“super-renormalizable”) interactions cause problems!

Consider, e.g., the mass term $m^2 \phi^2$ in scalar field theory

Dimensional analysis suggests that $m^2 \sim M^2 \sim \Lambda_{\text{UV}}^2$

But then a light scalar particle should not be present in the low-energy effective theory!

Hierarchy problem!

The same argument applies for all mass terms in any QFT (and likewise for the cosmological constant) !

Modern quantum field theory

New paradigm: EFTs must be **natural** in the sense that **all mass terms should be forbidden** by (exact or broken) symmetries!

Indeed:

- **gauge invariance:** forbids mass terms for gauge fields (photons and gluons in the Standard Model)
- **chiral symmetry:** forbids mass terms for fermions (all matter fields in the Standard Model)

Explains why the SM is a chiral gauge theory!

- **Supersymmetry:** would link the masses of scalars and fermions and, in combination with chiral symmetry, forbid mass terms for scalar fields (solves the hierarchy problem)

Effective field theory

Lecture III: Concepts of Effective Field Theory

- Basic ideas, Wilsonian effective action
- Scale separation, integrating out high-energy modes, low-energy effective Lagrangian, dimensional analysis
- Modern view of QFTs and general principles

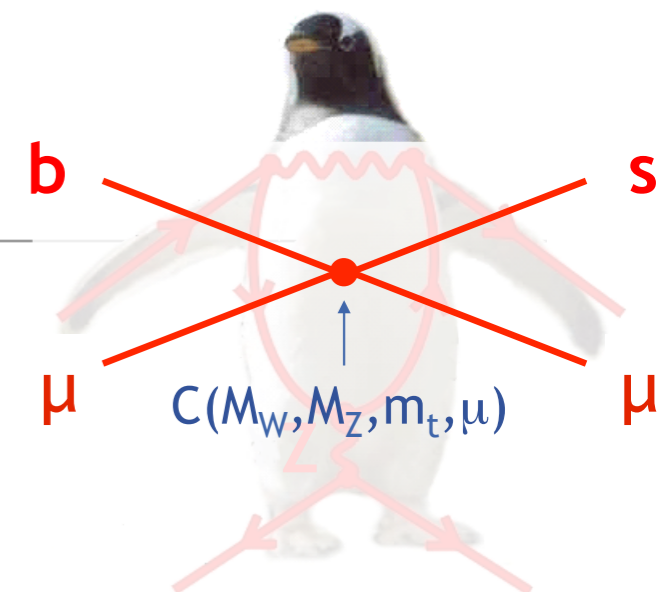

Lecture IV: Applications of Effective Field Theory

- The Standard Model as an effective field theory
- Several examples of applications beyond the Standard Model
- Interesting insights

Lecture IV: Applications of Effective Field Theory

Standard Model as an effective field theory

Some interesting insights can be gained by considering the Standard Model (SM) as a low-energy effective theory of some more fundamental theory (supersymmetry, extra dimensions, new strongly coupled physics, GUT, ...)

We will denote the **scale of New Physics** by M ; this could be as large as 10^{16} GeV for some applications, but as small as 10^3 GeV for others

The SM Lagrangian should then be extended to an effective Lagrangian, which besides the SM terms contains **additional, irrelevant operators**

These operators must **respect the symmetries of the SM** (gauge invariance, Lorentz symmetry, CPT) but are otherwise unrestricted

Standard Model as an effective field theory

- Standard Model is most successful effective field theory to date, even though it leaves open some questions:

The diagram illustrates the Standard Model as an effective field theory (EFT) with various physical questions highlighted in yellow boxes and arrows pointing to specific terms in the Lagrangian equation.

$$\mathcal{L}_{\text{EFT}} = c^{(0)} M^4 + c^{(2)} M^2 O^{(d=2)} + \sum_i c_i^{(4)} O_i^{(d=4)} + \frac{1}{M} \sum_i c_i^{(5)} O_i^{(d=5)} + \frac{1}{M^2} \sum_i c_i^{(6)} O_i^{(d=6)} + \dots$$

Annotations:

- Higgs mass (hierarchy problem)** points to the $c^{(2)} M^2 O^{(d=2)}$ term.
- cosmological constant** points to the $c^{(0)} M^4$ term.
- renormalizable quantum field theories** points to the $\sum_i c_i^{(4)} O_i^{(d=4)}$ term.
- neutrino masses (see-saw mechanism)** points to the $\frac{1}{M} \sum_i c_i^{(5)} O_i^{(d=5)}$ term.
- possible effects of "new physics", proton decay, flavor physics, ...** points to the $\frac{1}{M^2} \sum_i c_i^{(6)} O_i^{(d=6)}$ term.

Standard Model as an effective field theory

We will discuss a couple of interesting aspects of SM physics from the perspective of these constructions:

- weak interactions
- anomalous magnetic moment of the muon
- proton decay
- conservation of baryon and lepton numbers (accidental symmetries)
- neutrino masses and see-saw mechanism
- Higgs production at the LHC

Weak interactions at low energies (flavor physics)

Fermi's description of the weak interactions at low energy is a prime example of an effective field theory, which has provided first evidence for the **scale of electroweak symmetry breaking**

At the low energies relevant for neutron β -decay, kaon physics, charm physics or B-meson physics (few MeV - few GeV), we can integrate out the heavy W and Z bosons as well as the top-quark and Higgs boson from the SM

This gives rise to a low-energy effective theory containing **4-fermion interactions** (Fermi theory) and **dipole interactions** between fermions and the photon and gluon

This effective Lagrangian successfully describes the huge phenomenology of **flavor-changing processes**

Weak interactions at low energies (flavor physics)

Example: Effective Lagrangian for $b \rightarrow s$ FCNC transitions
(see Buras lectures for a derivation)

$$\mathcal{H}_{\text{eff}} = \frac{G_F}{\sqrt{2}} \sum_{p=u,c} \lambda_p \left(C_1 Q_1^p + C_2 Q_2^p + \sum_{i=3,\dots,10} C_i Q_i + C_{7\gamma} Q_{7\gamma} + C_{8g} Q_{8g} \right)$$

$$Q_1^p = (\bar{p}b)_{V-A} (\bar{s}p)_{V-A},$$

$$Q_2^p = (\bar{p}_i b_j)_{V-A} (\bar{s}_j p_i)_{V-A},$$

$$Q_3 = (\bar{s}b)_{V-A} \sum_q (\bar{q}q)_{V-A},$$

$$Q_4 = (\bar{s}_i b_j)_{V-A} \sum_q (\bar{q}_j q_i)_{V-A},$$

$$Q_5 = (\bar{s}b)_{V-A} \sum_q (\bar{q}q)_{V+A},$$

$$Q_6 = (\bar{s}_i b_j)_{V-A} \sum_q (\bar{q}_j q_i)_{V+A},$$

$$Q_7 = (\bar{s}b)_{V-A} \sum_q \frac{3}{2} e_q (\bar{q}q)_{V+A},$$

$$Q_8 = (\bar{s}_i b_j)_{V-A} \sum_q \frac{3}{2} e_q (\bar{q}_j q_i)_{V+A},$$

$$Q_9 = (\bar{s}b)_{V-A} \sum_q \frac{3}{2} e_q (\bar{q}q)_{V-A},$$

$$Q_{10} = (\bar{s}_i b_j)_{V-A} \sum_q \frac{3}{2} e_q (\bar{q}_j q_i)_{V-A},$$

$$Q_{7\gamma} = \frac{-e}{8\pi^2} m_b \bar{s} \sigma_{\mu\nu} (1 + \gamma_5) F^{\mu\nu} b,$$

$$Q_{8g} = \frac{-g_s}{8\pi^2} m_b \bar{s} \sigma_{\mu\nu} (1 + \gamma_5) G^{\mu\nu} b,$$

Weak interactions at low energies (flavor physics)

Example: Effective Lagrangian for $b \rightarrow s$ FCNC transitions
(see Buras lectures for a derivation)

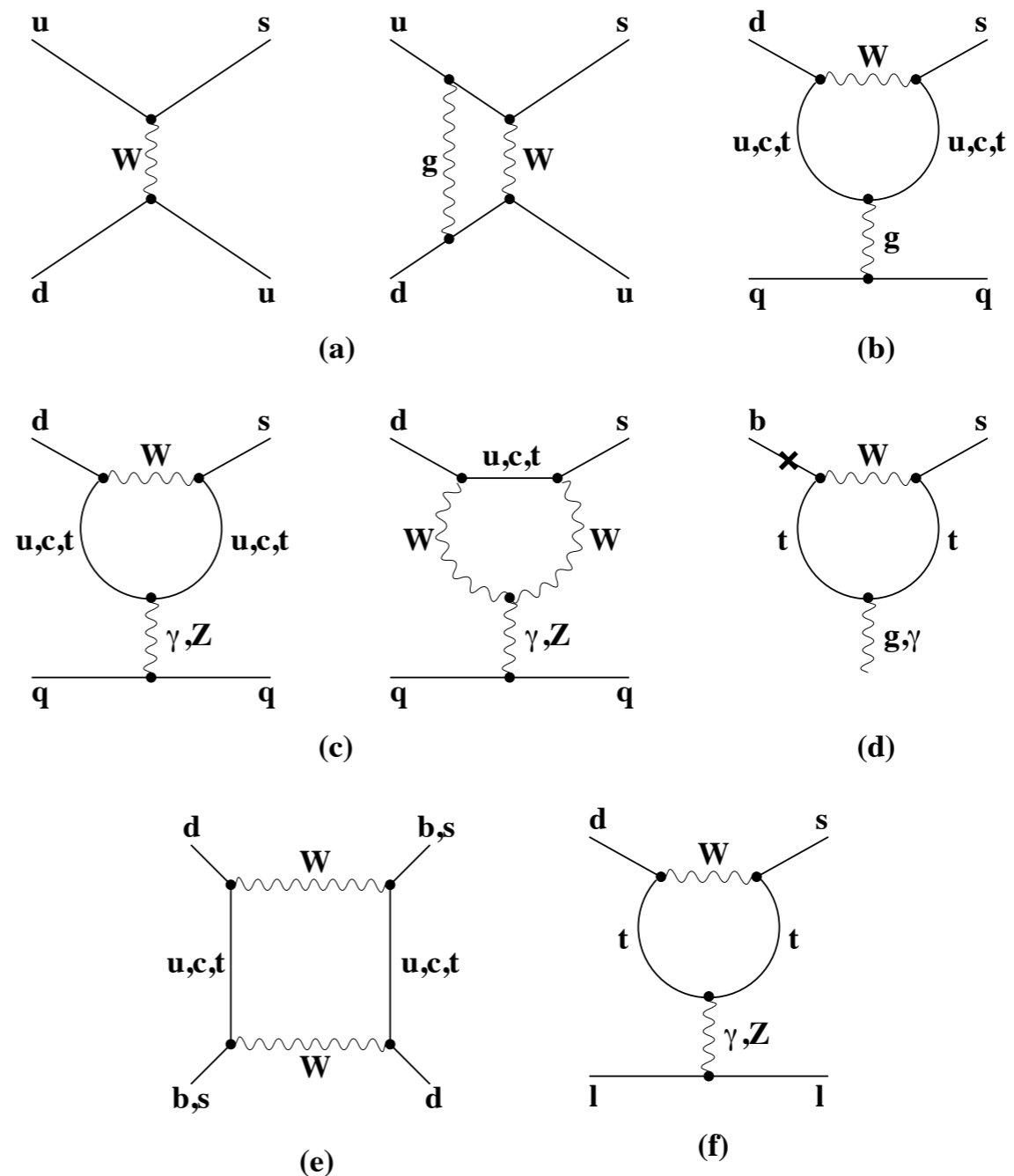

SM diagrams involving virtual heavy-particle exchanges contributing to the low-energy effective weak Lagrangian

Weak interactions at low energies (flavor physics)

Example: Effective Lagrangian for $b \rightarrow s$ FCNC transitions
(see Buras lectures for a derivation)

From the fact that the **leading operators** in the low-energy effective theory have **dimension 6**, it follows that the corresponding couplings are **irrelevant** and proportional to M_W^2 , indeed:

$$\frac{G_F}{\sqrt{2}} = \frac{g_2^2}{8M_W^2}$$

The strong suppression of these contributions at low energies explains why we refer to these interactions as the **weak interactions**, even though the coupling constants of the $SU(2)_L \otimes U(1)_Y$ electroweak interactions is about as large as the electromagnetic coupling constant

Anomalous magnetic moment of the muon

In a celebrated calculation that was the birth of modern QFT, Schwinger computed the anomalous magnetic moment of the electron in 1948 and found:

$$\mu_e = \frac{g_e}{2m_e}, \text{ with } a_e = \frac{g_e - 2}{2} = \frac{\alpha}{2\pi} + \dots$$

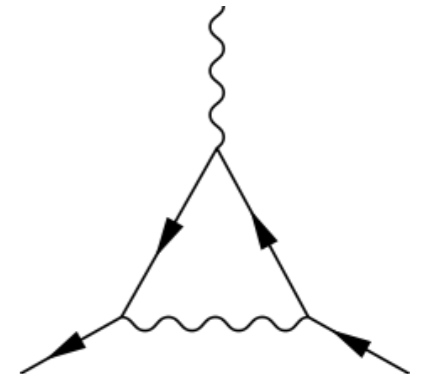

How will this result be affected if the SM is considered as an effective field theory?

Anomalous magnetic moment of the muon

In a celebrated calculation that was the birth of modern QFT, Schwinger computed the anomalous magnetic moment of the electron in 1948 and found:

$$\mu_e = \frac{g_e}{2m_e}, \text{ with } a_e = \frac{g_e - 2}{2} = \frac{\alpha}{2\pi} + \dots$$

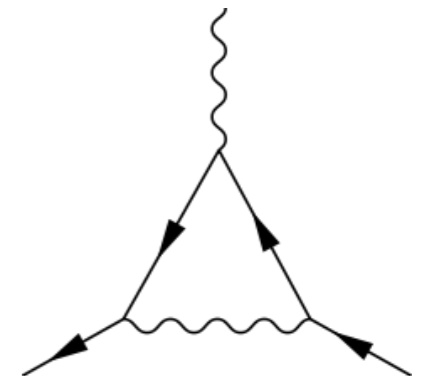

How will this result be affected if the SM is considered as an effective field theory?

Add **unique** dimension-5 operator ($\delta = 5$, $\gamma = -1$):

$$\frac{gv}{M^2} \bar{\psi} \sigma_{\mu\nu} F^{\mu\nu} \psi$$

factor v required by EWSB

Anomalous magnetic moment of the muon

In a celebrated calculation that was the birth of modern QFT, Schwinger computed the anomalous magnetic moment of the electron in 1948 and found:

$$\mu_e = \frac{g_e}{2m_e}, \text{ with } a_e = \frac{g_e - 2}{2} = \frac{\alpha}{2\pi} + \dots$$

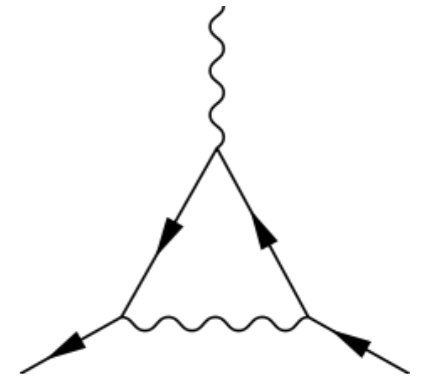

This adds g/M to μ_e and hence:

$$a_e = \frac{\alpha}{2\pi} + \frac{gm_e v}{M^2} + \dots$$

As long as $M \gg m_e$ the additional term will be very small, and by comparing a measurement of μ_e with theory we can constrain M

Anomalous magnetic moment of the muon

Analogous discussion (with m_e replaced by m_μ) holds for the muon

In this case, there is presently a **3.6 σ discrepancy** between theory and experiment:

$$a_\mu^{\text{SM}} - a_\mu^{\text{exp}} \approx -2.8 \cdot 10^{-9}$$

Interpreting this effect in terms of our irrelevant operator implies that:

$$M \sim \sqrt{g} \times 100 \text{ TeV}$$

contains loop factor (small)

One of the best hints for BSM physics!

Proton decay

Suppose you know the gauge symmetry $SU(3)_c \otimes SU(2)_L \otimes U(1)_Y$ of the SM but nothing else (no GUTs). What could you say about proton decay?

The effective Lagrangian must contain at least **three quark fields** (change baryon number by 1 unit) and **one lepton field** (change lepton number by 1 unit)

Hence:

$$\mathcal{L}_{\text{proton decay}} \sim \frac{g}{M^2} qqq\ell$$

Since the lowest-dimension operators have dimension 6 (corresponding to $\gamma_i = -2$), the proton can be made sufficiently long-lived by raising the fundamental scale M into the 10^{16} GeV range

Proton decay

Now imagine that you do not know about the existence of quarks (no one has seen any) but you do know about protons and pions

Then an effective Lagrangian giving proton decay could be:

$$\mathcal{L}_{\text{proton decay}} \sim g \pi \bar{\psi}_e \psi_p$$

This is a marginal operator, and hence proton decay would not be suppressed by any large mass scale!

In some sense, we see that the **longevity of the proton** provides a hint for a substructure of the proton: **replacing a fundamental field by a composite of several fields** raises the dimension of the operators and hence gives rise to additional suppression

Proton decay

The same trick can be applied to other fine-tuning problems

For example, the hierarchy problem can be solved by supposing that the **Higgs boson is not an elementary scalar** particle but instead a **composite of a pair of elementary fermions**

If this is the case, then the Higgs mass term corresponds to a 4-fermion operator, which is irrelevant

This is the main idea of **technicolor theories**

Baryon and lepton number conservation

In the construction of the SM, the conservation of baryon and lepton number is *not* imposed as a condition

There are no corresponding U(1) symmetries of the Lagrangian

How can we understand that in nature we have not seen any hints of baryon- or lepton-number violating processes?

Baryon and lepton number conservation

In the construction of the SM, the conservation of baryon and lepton number is *not* imposed as a condition

There are no corresponding U(1) symmetries of the Lagrangian

How can we understand that in nature we have not seen any hints of baryon- or lepton-number violating processes?

The answer is that **it is impossible to construct any relevant or marginal operator** that would respect the gauge symmetries of the SM and **violate baryon or lepton number!**

Hence, at the level of renormalizable interactions, baryon- and lepton-number conservation are **accidental symmetries** of the SM

Neutrino masses

The discovery of **non-zero neutrino masses** is often described as a departure from the SM

But this is no longer true if we consider the SM as an effective low-energy theory

Without a right-handed neutrino (which indeed is not part of the SM), it is impossible to write a neutrino mass term at the level of relevant or marginal operators

However, it **is** possible to write a gauge-invariant **neutrino mass term** at the level of **irrelevant operators** of dimension ≥ 5 :

$$\mathcal{L}_{\text{neutrino mass}} = \frac{g}{M} (\tilde{l}_L^T \Phi^*) C (\tilde{\Phi} l_L)$$

Neutrino masses

However, it **is** possible to write a gauge-invariant **neutrino mass term** at the level of **irrelevant operators** of dimension ≥ 5 :

$$\mathcal{L}_{\text{neutrino mass}} = \frac{g}{M} (\tilde{l}_L^T \Phi^*) C (\tilde{\Phi} l_L)$$

After electroweak symmetry breaking, this gives rise to a Majorana mass term of the form:

$$\mathcal{L}_{\text{neutrino mass}} = -\frac{v^2 g}{2M} \tilde{\nu}_L^T C \nu_L$$

The SM as an effective field theory **predicts** that neutrinos should be massive, with $m_\nu \sim v^2/M$ suppressed by the fundamental scale of some BSM physics

Neutrino masses and the see-saw mechanism

Experiments hints at the fact that the fundamental scale relevant for the generation of neutrino masses is very heavy,

$$M \sim 10^{14} \text{ GeV}$$

which is not far from the scale of grand unification

Extensions of the SM containing **heavy, right-handed neutrinos** (with masses that are naturally of order M) provide explicit examples of fundamental theories which yield such a Majorana mass term when the heavy, right-handed neutrinos are integrated out (**see-saw mechanism**)



Higgs production at the LHC

The protons collided at the LHC contain only light quarks (u,d, and a little bit of s), which in the SM have negligible couplings to the Higgs boson, and gluons, which do not couple to the Higgs boson at all

How, then, is the Higgs boson produced in pp collisions at the LHC?

Higgs production at the LHC

The protons collided at the LHC contain only light quarks (u,d, and a little bit of s), which in the SM have negligible couplings to the Higgs boson, and gluons, which do not couple to the Higgs boson at all

How, then, is the Higgs boson produced in pp collisions at the LHC?

We can gain insight by assuming (as seems to be the case) that the Higgs boson is lighter than the top quark

We can then construct an effective low-energy theory for Higgs physics, in which the top quark is integrated out

Higgs production at the LHC

In this effective low-energy theory, direct couplings of the Higgs boson to pairs of gluons and photons arise at the level of **irrelevant dimension-5 operators**, with coefficients that scale like $1/m_t$, e.g.:

$$\mathcal{L}_{hgg} = \frac{y_t}{\sqrt{2}m_t} \frac{\alpha_s}{12\pi} h G_{\mu\nu}^a G^{\mu\nu,a}$$

These operators appear first at one-loop order, via the exchange of a virtual top-quark

The **effective hgg interaction** provides the dominant production mechanism for the Higgs boson in **gluon-gluon fusion** at the LHC

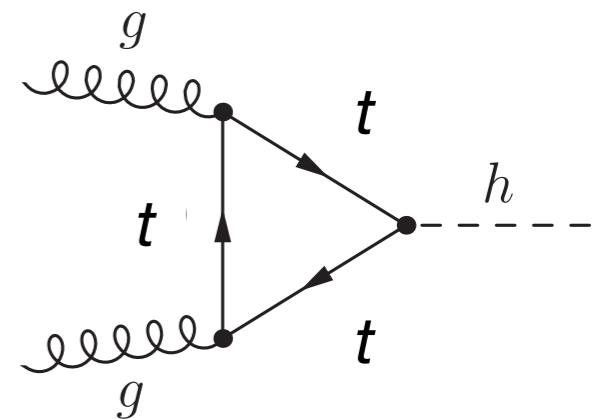

Summary

Effective field theories are a very powerful tool in quantum field theory

They are of great **practical use**, but also provide the **conceptual tools** to understand scale separation (factorization) and renormalization in a physical and systematic way

Effective field theories are abundant, since any QFT can be considered as an effective low-energy theory of some more fundamental theory, which is often not yet known

Because of this fact, effective field theories provide the tools to perform **indirect searches for new physics** beyond the Standard Model