ALICE3

unas observaciones

Guy

momento crucial



Primero felicidades y gracias a Antonio para tomar la iniciativa para reunirnos para una reflexión que creo clave para la década que sigue para la posición de Mexico en una pequeña parte de la frontera de la ciencia.

Gerardo dio un
nuevo giro a la
física de altas
energías en
Mexico en el
siglo pasado

Mexico debe contribuir a los
experimentos con
contribuciones de detectores
hechos en Mexico

Precursor to the Herrera doctrine for Mexico....

“New directions in science are launched by new tools much more often than by new concepts. The effect of a concept-driven revolution is to explain old things in new ways. The effect of a tool-driven revolution is to discover new things that have to be explained” (Freeman Dyson)

“Measure what is measurable, and make measurable what is not so” (Galileo Galilei)



Una experiencia en los detalles de construcción detectores permite elegir los problemas lo mas interesante



Que nos ofrece un experimento dado – porque el chiste esta hacer ciencia de primera....

A posible addendum

The 2021 ECFA detector research and development roadmap

Within each Task Force (one for each technology area + training) the aim is to propose a time ordered detector R&D programme by Detector Research and Development Themes (DRDT) in terms of capabilities not currently achievable



Una selección personal que me parece aceptable por los costos y interés físico....

PID and Photon

- DRDT 4.1** Enhance the timing resolution and spectral range of photon detectors
- DRDT 4.2** Develop photosensors for extreme environments
- DRDT 4.3** Develop RICH and imaging detectors with low mass and high resolution timing
- DRDT 4.4** Develop compact high performance time-of-flight detectors

Mi orientación para los “últimos años en el ICN”

Obviamente se acuerden que yo estuve uno
delo constructores de HMPI

■ Esto es una orientación que me permito tomar para lo que creo sería un cierre digno a mi actividad en Mexico. – eso no quiere decir que no estoy dispuesto a colaborar con cualquier decisión de este for.

ALICE3 - múltiples posibilidades

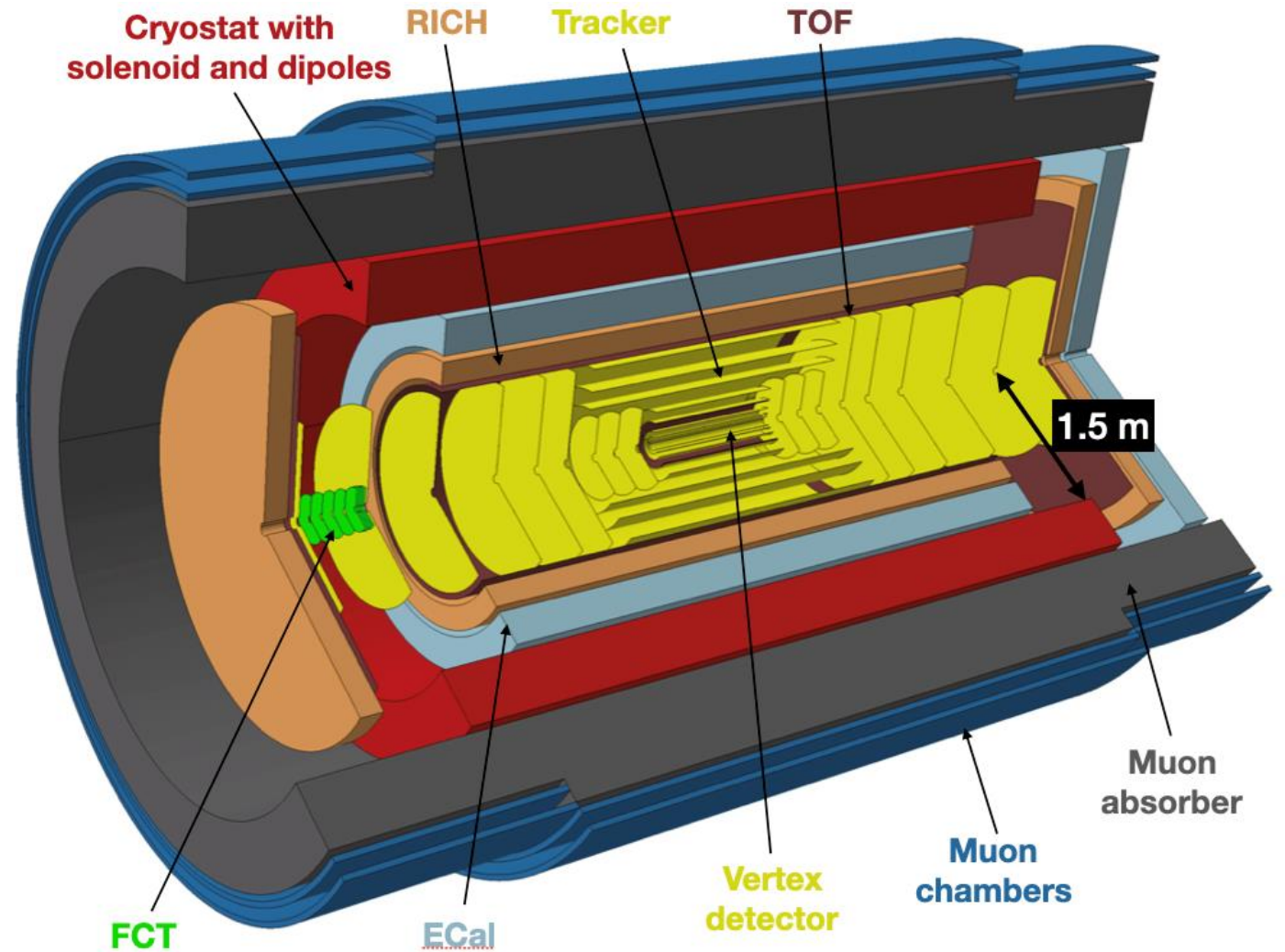

THE PHOTON DETECTOR FOR THE ALICE3 AEROGEL RICH DETECTOR

Main requirements

- Rayleigh scattering → Single photon sensitivity in the visible range (PDE > 40-50%) → Gaseous PDs is not a viable solution
- Integration fill factor > 90%
- Pixel ~ 3x3 mm²
- Time jitter $\sigma < \sim 100$ ps
- **Area coverage ~ 38 m²**
- **Magnetic field 0.5 T (option 2 T)**
- Expected radiation load: $\sim 10^{12}$ MeV n_{eq} /cm²

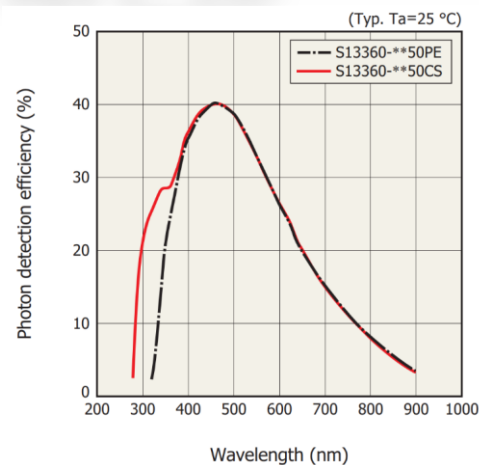
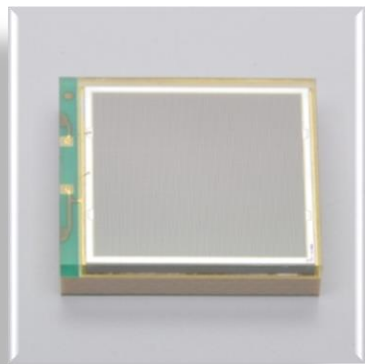

VIABLE SOLUTION: SiPMs

Example: SiPM HPK 13360 3050CS,

- 3x3 mm² pixel (microcell of 3600 SPADs with 50 μ m pitch)
- Dark count rate (DCR) ~ 50 kHz/mm²
- 50 ps time resolution (RMS)

Compared to nominal TOF

20 ps resolution

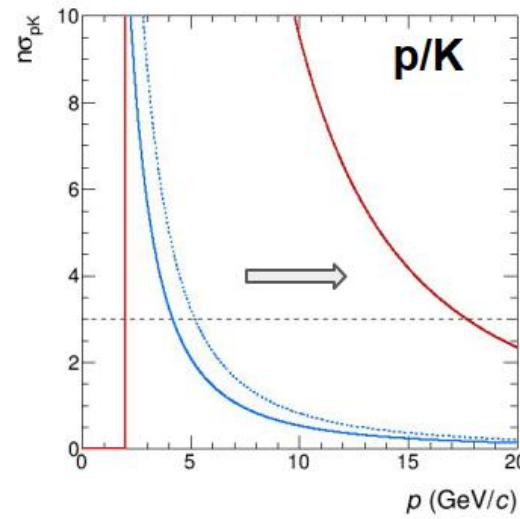
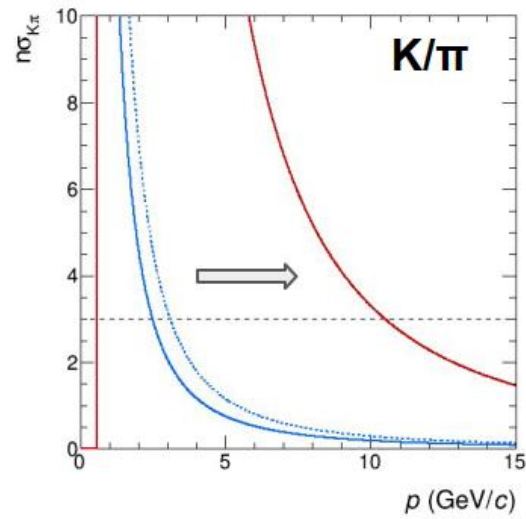
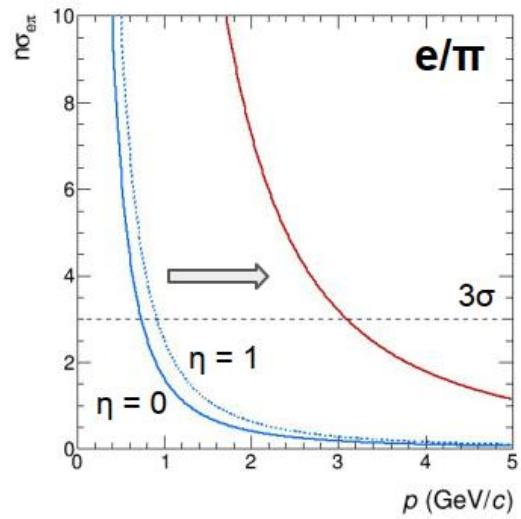

3 σ separation up to

e/π ~ 3 GeV/c

K/π ~ 10 GeV/c

p/K ~ 18 GeV/c

valuable extension
of TOF capabilities

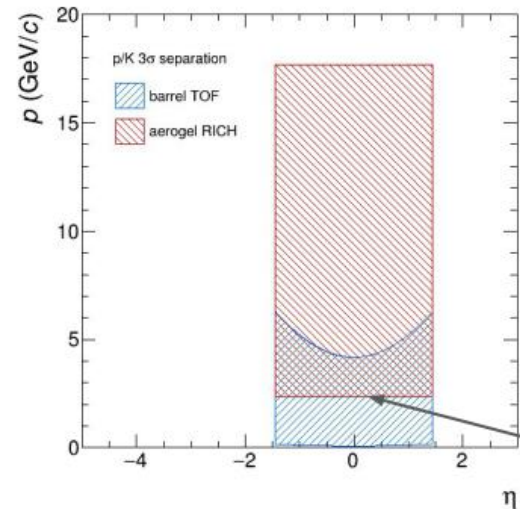
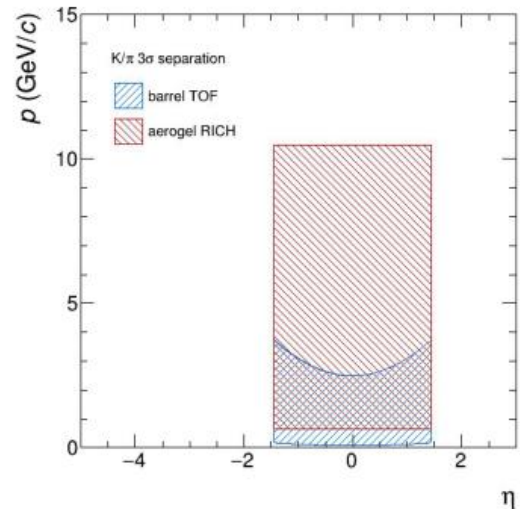
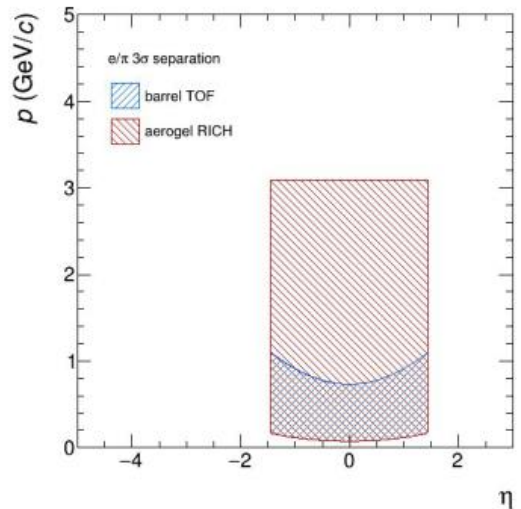

warning:
low momentum efficiency turn-on
yet not included in the model

Results by R. Preghenella from “fast” parametric simulation, assuming a Cherenkov angle resolution at saturation of 1.5 m

Preparing for October test beam

photo-detector based on Hamamatsu sensors arranged in strip of 128 13552 (0.25x1.62 mm) and matrix of 8x8 13361-3050AE (3x3 mm)

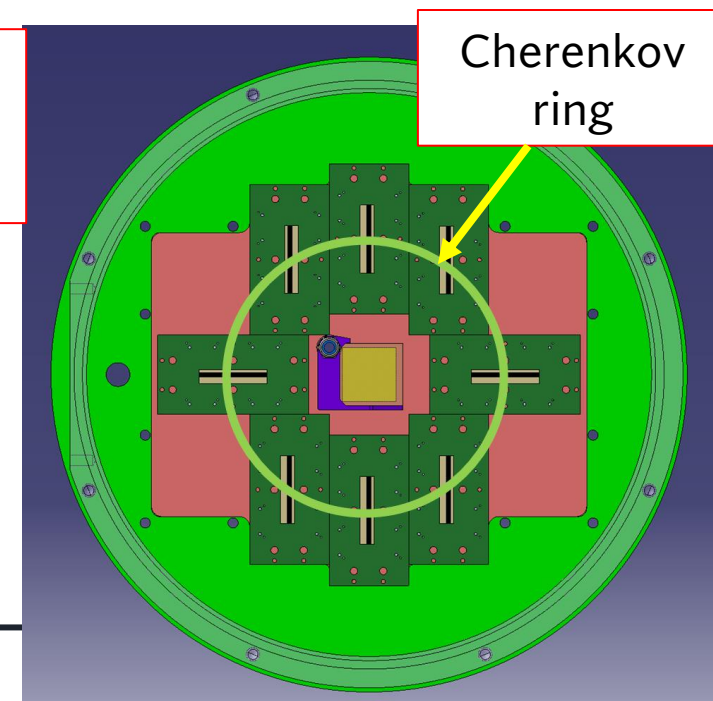
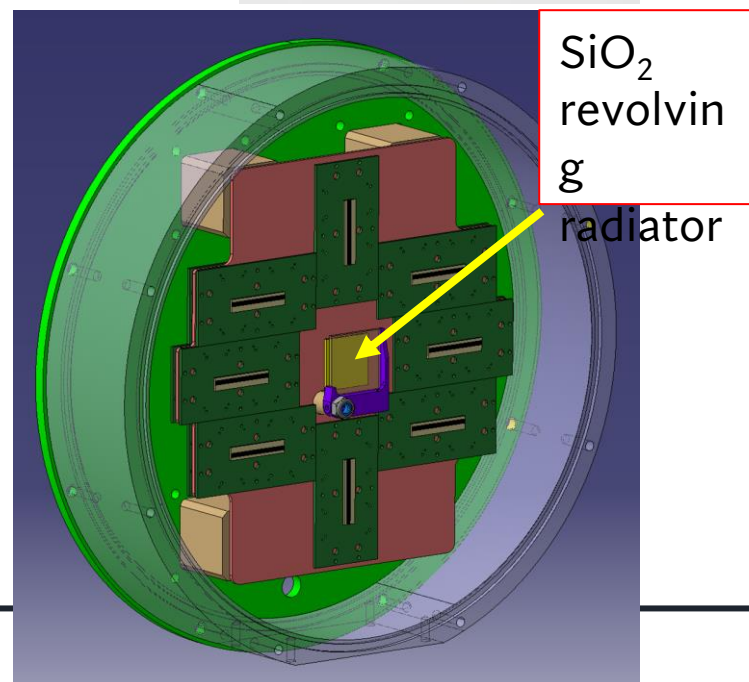
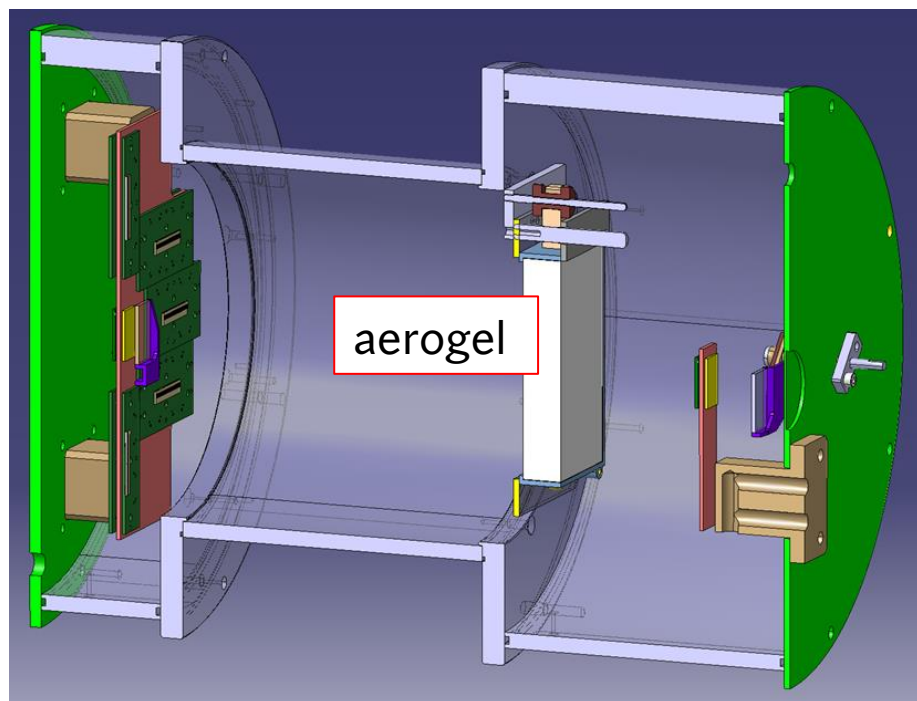
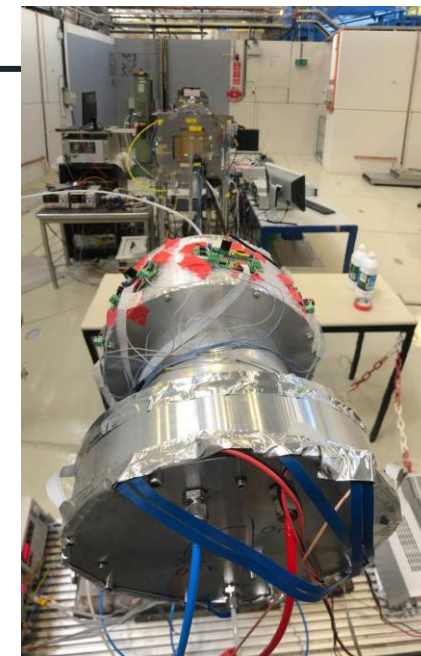
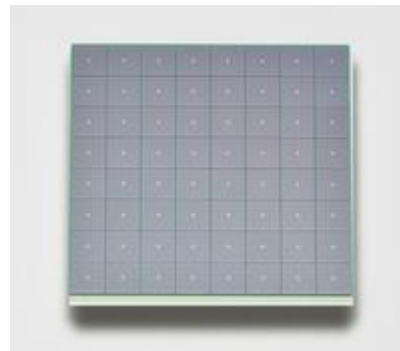
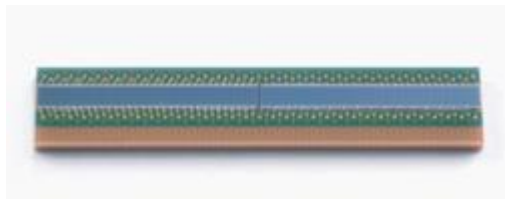

Compared to nominal TOF

20 ps resolution

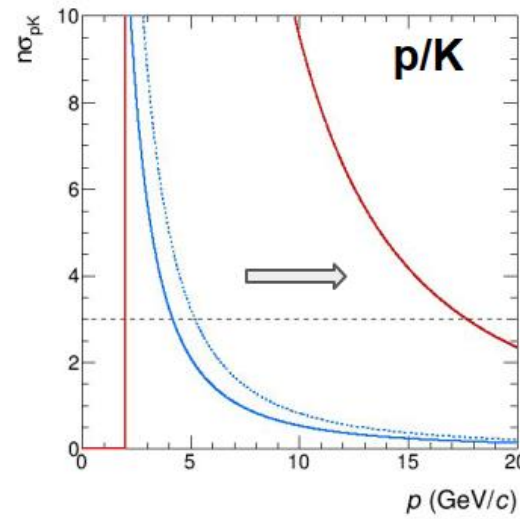
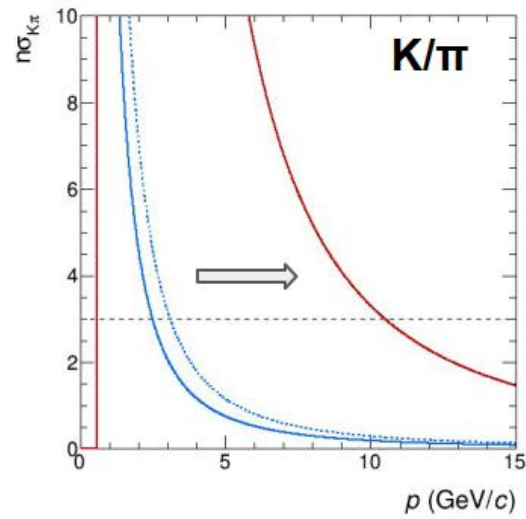
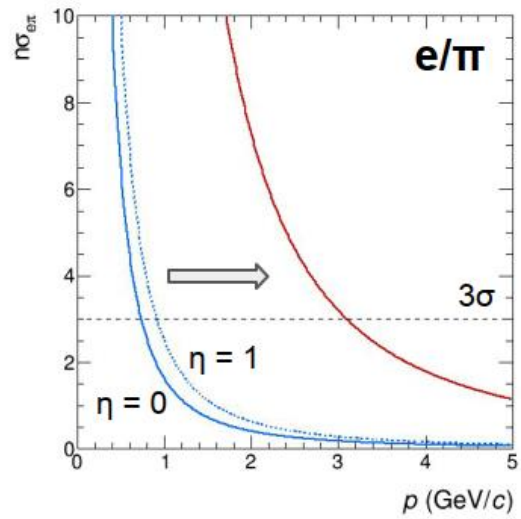

3σ separation up to

$e/\pi \sim 3$ GeV/c

$K/\pi \sim 10$ GeV/c

$p/K \sim 18$ GeV/c

valuable extension
of TOF capabilities

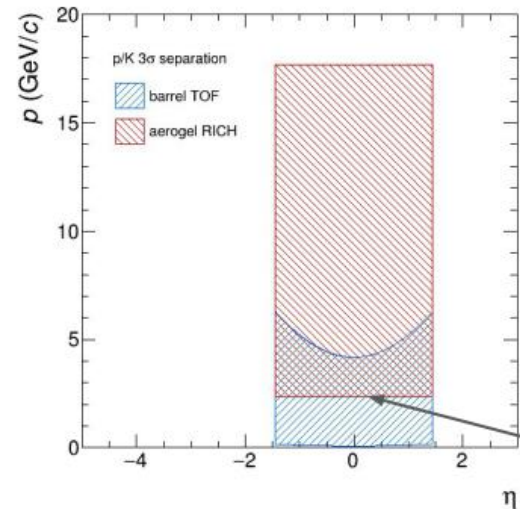
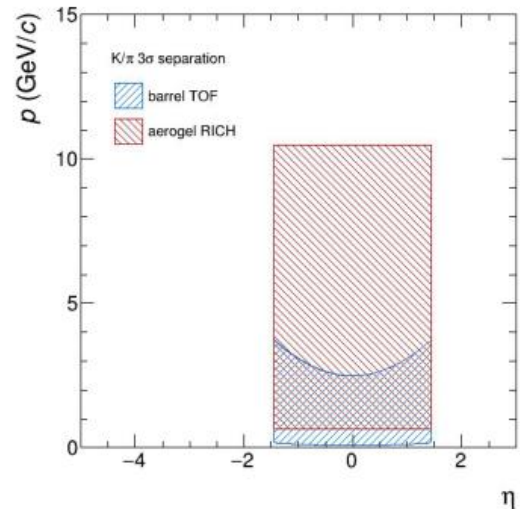
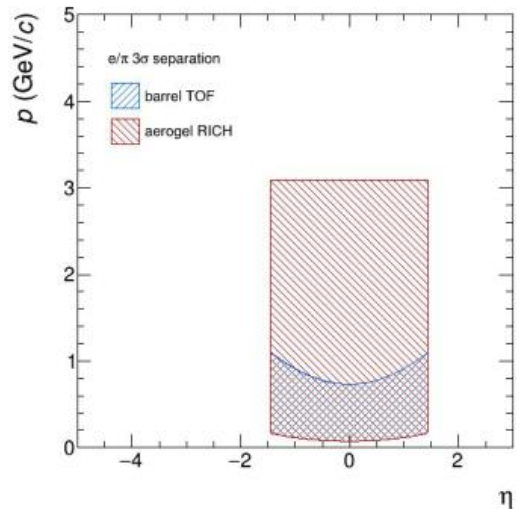

warning:
low momentum efficiency turn-on
yet not included in the model

Results by R. Preghenella from “fast” parametric simulation, assuming a Cherenkov angle resolution at saturation of 1.5 m

Observaciones finales

Las tecnologías que se proponen no son fáciles . Necesitan extrapolación de las tecnologías existentes

Esto es el reto!!

El dominio de tal tecnología abre las puertas para escoger las mejores opciones de física

Con propósito no toque los temas de física pero estoy seguro que son igualmente interesantes.

Gracias

- The rapid evolution of SPADs (the fundamental element of SiPM) based on CMOS imaging sensor (CIS) technology in relation to the increasing demand for consumer and automotive applications; the sensor cost in standard CIS process is at least a factor 10 smaller than commercial analogue SiPMs.
- The possibility to integrate circuitry for time gating logic and DCR reduction by masking "hot" SPADs.
- The "monolithic" approach and the implementation of electronics inside the sensor simplifies the integration and minimizes the material budget, with clear advantages also on construction costs.
- Possibility to develop a fully customized sensor and optimize the key performance parameters (PDE, DCR and correlated noise, radiation tolerance). The availability of backside illumination in the so-called 3D stacking increases the chances of maximizing the fill factor of the 1st Tier and integrate the required electronics in the 2nd Tier.