

# Extensive Air Shower (EAS) Detection

Piera L. Ghia (IPNO-CNRS, Orsay, France)

“The subject of cosmic rays is unique in modern physics for  
**the minuteness of the phenomena**  
**the delicacy of the observations**  
**the adventurous excursions of the observers**  
**the subtlety of the analysis**  
**the grandeur of the inferences”**

(from Bruno Rossi, “Cosmic Rays”, foreword)



ISAPP 2019 @ the Pierre Auger Observatory

Malargüe, 7 March 2019

# OUTLINE

**PROLOGUE: the relevance of detecting Extensive Air Showers**

**Extensive Air Shower detection: an historical perspective**

***(The minuteness of the phenomena)***

***The adventurous excursions of the observers)***

**Modern Extensive Air Shower detectors**

***(The minuteness of the phenomena -***

***The adventurous excursions of the observers)***

**Two exemplary cases: the Auger Observatory and the Telescope Array**

**EAS observables *(The delicacy of the observations)***

**From EAS observables to cosmic rays properties *(The subtlety of the analysis)***

***NB. For the grandeur of the inferences, don't miss Michael Unger' seminar !***

# The relevance of EAS detection

## *The energy spectrum of cosmic rays*

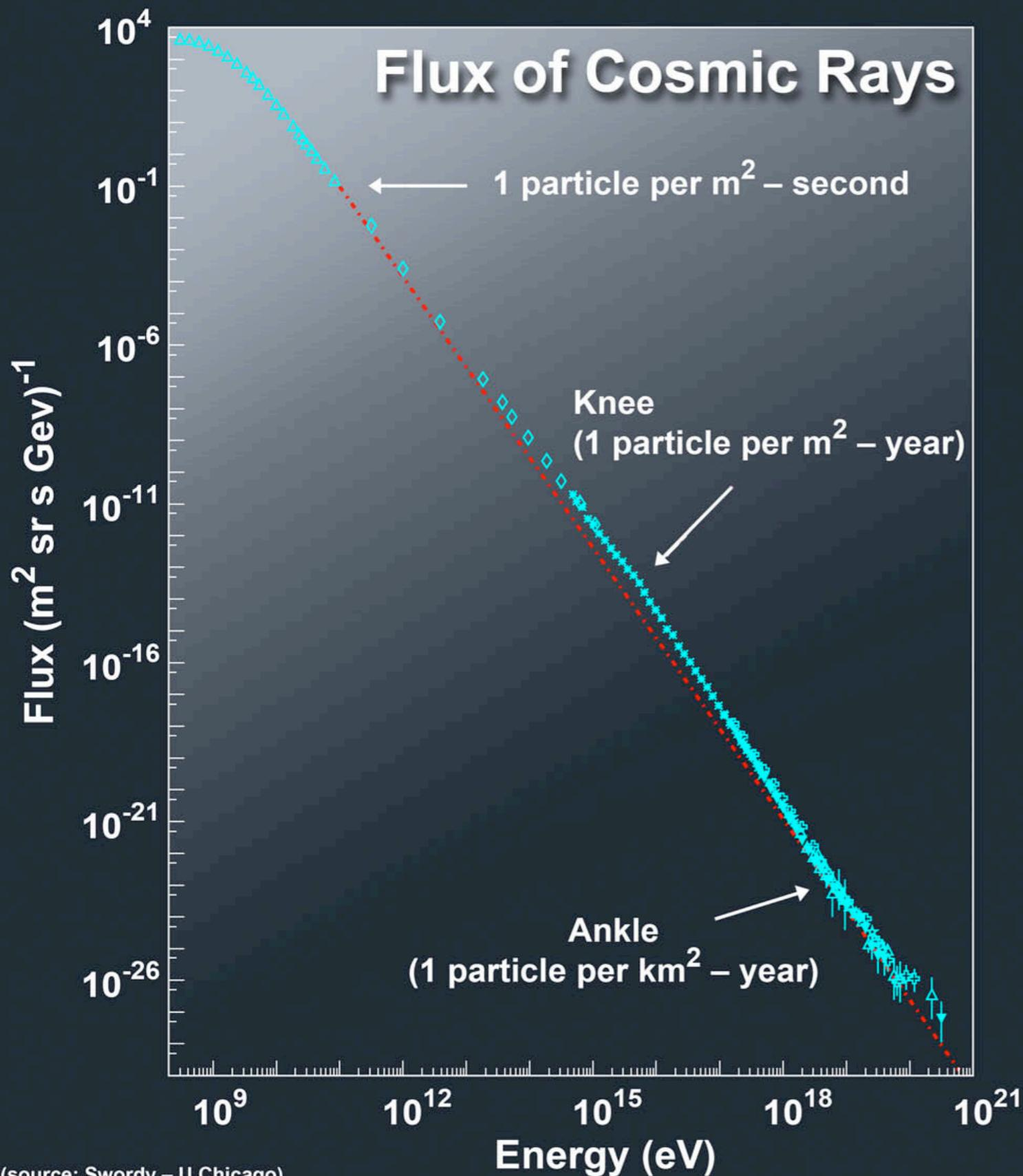

The most striking feature of cosmic rays is the fact that their energies span a very wide range

Their flux as a function of energy (the energy spectrum) is well represented by a power-law form :  
( $E^{-\gamma}$ ,  $\gamma \approx 3$ )

It is rather regular over  $\approx 13$  decades in energy, spanning  $\approx 32$  decades in flux!

# The relevance of EAS detection

*Different detection approaches depending on the CR energy*

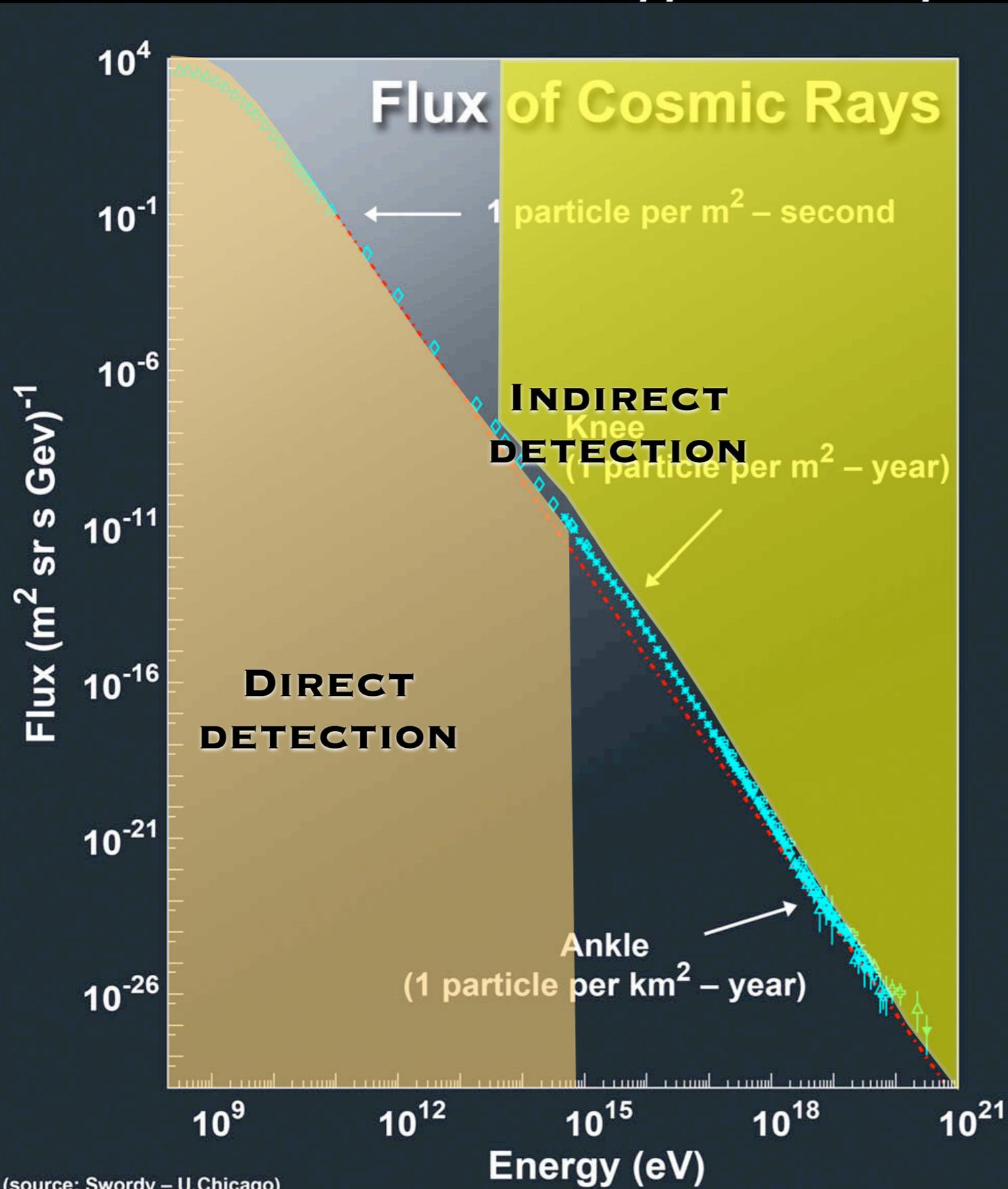

(source: Swordy – U.Chicago)

**At lower energies (below tens of TeV):** rather high flux ( $1/\text{m}^2$  s-h) but CRs are absorbed in the upper atmosphere.

**Direct detection** is needed and feasible, on balloons, rockets or satellites

**At higher energies (above tens of TeV):** much rarer ( $< 1/\text{m}^2\text{y}$ ), but “penetrating” up to ground (via their extensive air-showers).

**Indirect detection** is needed and feasible with long-lived large instruments deployed at Earth

# The relevance of EAS detection

*Different detection approaches depending on the CR energy*

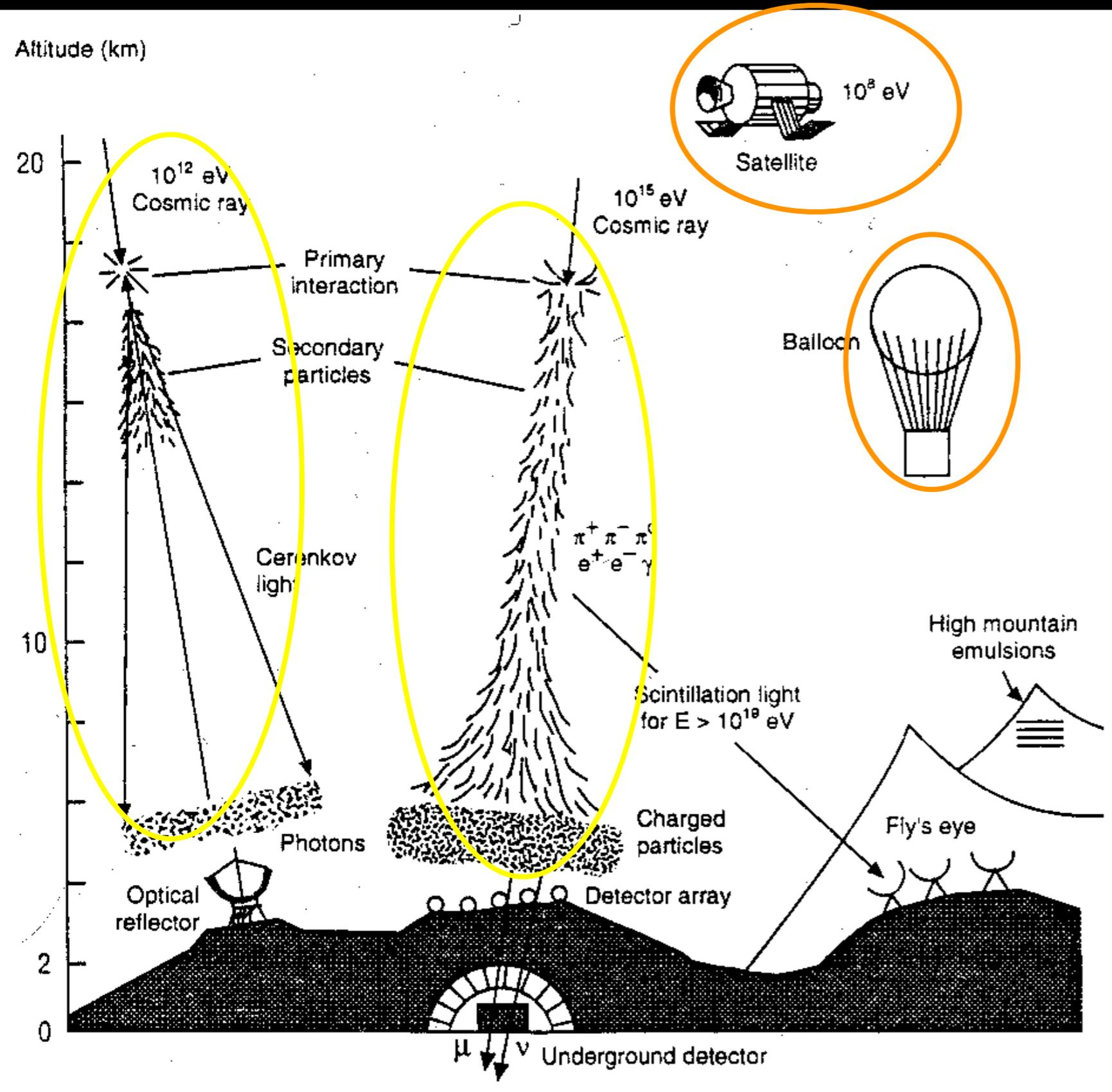

**At lower energies (below tens of TeV):** rather high flux ( $1/\text{m}^2\text{-h}$ ) but CRs are absorbed in the upper atmosphere.

**Direct detection** is needed and feasible, on balloons, rockets or satellites

**At higher energies (above tens of TeV):** much rarer ( $< 1/\text{m}^2\text{y}$ ), but “penetrating” up to ground (via their extensive air-showers).

**Indirect detection** is needed and feasible with long-lived large instruments deployed at Earth

# The relevance of EAS detection

*The energy spectrum of high-energy cosmic rays shows in fact a few “irregularities”*

- A softening (“knee”) at  $\approx 3 \cdot 10^{15}$  eV
- A softening (“II knee”) at  $\approx 10^{17}$  eV
- A hardening (“ankle”) at  $\approx 4 \cdot 10^{18}$  eV
- A “suppression” at  $\approx 5 \cdot 10^{19}$  eV

These irregularities reflect changes in the CR behaviour, either in the acceleration mechanisms, or the sources, or the propagation to Earth.

The experimental study of CRs around these energies is key to understand their origin. **Different instruments for their (indirect) detection are required depending on the energy**

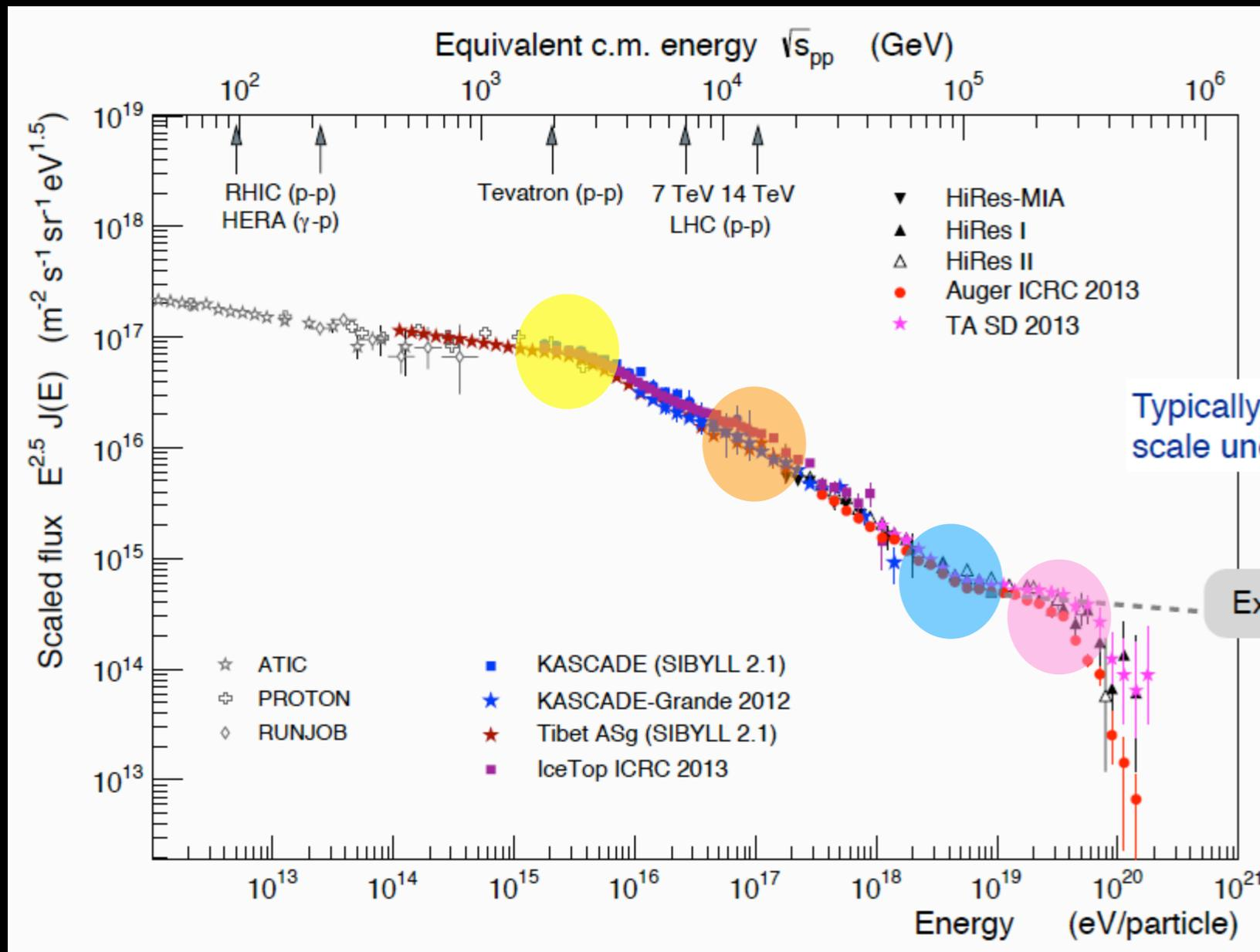

ALL-PARTICLE PRIMARY ENERGY SPECTRUM MEASURED BY DIFFERENT EAS ARRAYS. SPECTRUM SCALED BY  $E^{2.5}$  TO BETTER EVIDENCE THE “IRREGULARITIES”

# The challenge of EAS detection

*The ultimate aim of EAS detection is the identification of the primary cosmic ray, in terms of*

**Mass/Charge**

**Energy**

**Arrival direction**

**We are dealing with an INDIRECT MEASUREMENT of CRs**

**To infer the properties of the primary particle one needs not only to detect EAS as precisely as possible but also to exploit as carefully as possible the “legacy” that their parents left into them**

***Extensive Air Shower detection:***  
*An historical perspective*

***The minuteness of the phenomena***  
***The adventurous excursions of the observers***



# Nani gigantum humeris insidentes

*If I have seen further, it is by standing on the shoulders of giants*

*“I make no apology for showing here and there a few historical notes about the history of cosmic ray detection.*

*This is much more than simply the recounting of some key events. Many of the present key ideas and experimental procedures have a long and distinguished history which reflects the insight and ingenuity of the great scientists of the past. These are our legacy and the foundation of the modern scientific experimental practice”*  
*(inspired - and adapted - from Malcolm Longair)*



Chartres Cathedral  
South Rose  
St Matthew above Isaiah



Chartres Cathedral  
South Rose  
St Luke above Jeremiah

It is (quite) easy today to talk about the techniques used to detect and to exploit EAS to study cosmic rays

Yet, it took decades to consolidate the picture of EAS, both in terms of detection and of the physical processes involved

# The very first steps towards the discovery of EAS

## *First of all: the discovery of cosmic rays!*

First hints of the presence of cosmic rays came quite unexpectedly at the turn of 20<sup>th</sup> century, during the golden days of research into radioactivity. Radioactive elements ionise gases, enabling the gas to conduct electricity. Electroscopes were widely used to explore radioactive materials.

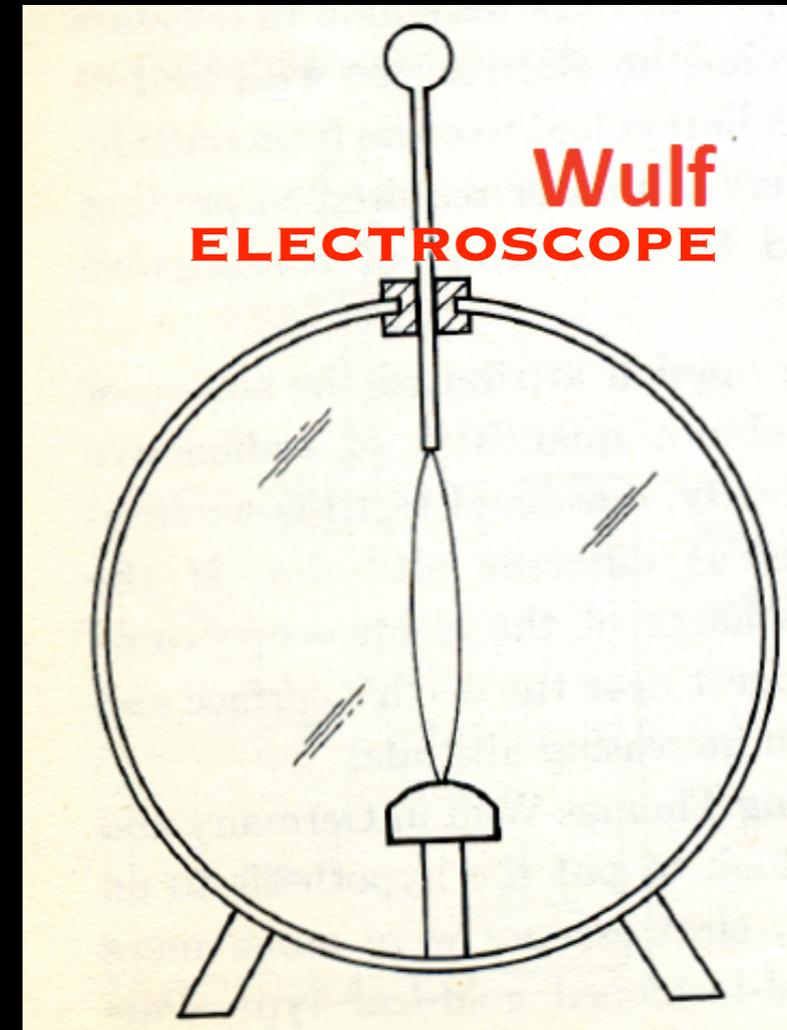
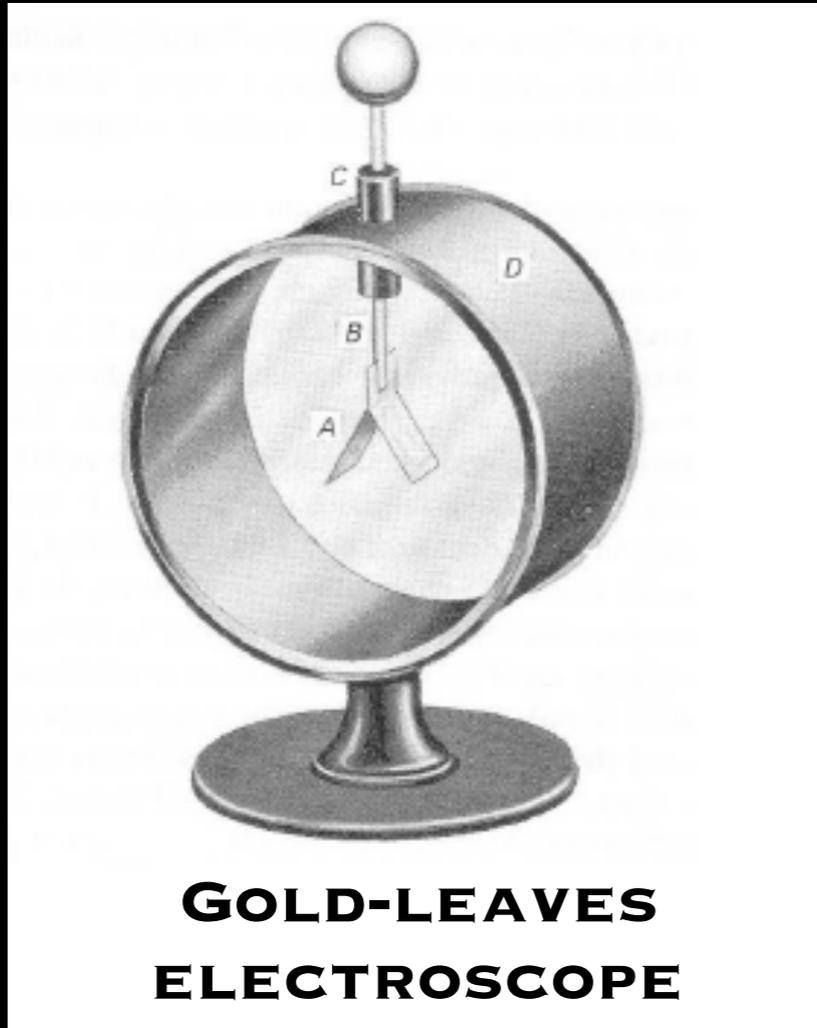

When an electroscope is given an electric charge, the leaves (or wires) repel each other and stand apart. Radiation can ionise the air in the electroscope and allow the charge to leak away: leaves or wires slowly come back together.

**Puzzling inference: No matter how good the electroscopes, the electric charge continued to leak away even when there was no obvious nearby source of X-rays or radioactivity!**

# The very first steps towards the discovery of EAS

*First of all: the discovery of cosmic rays!*

To reduce possible effect of sources of radiation at ground, electroscopes were carried to the tops of tall buildings (Father Wulf, 1910, Eiffel Tower) or even to greater heights, using balloons (Victor Hess, 1912, Werner Kolhorster, 1913-1914). Experiments of great danger, great courage

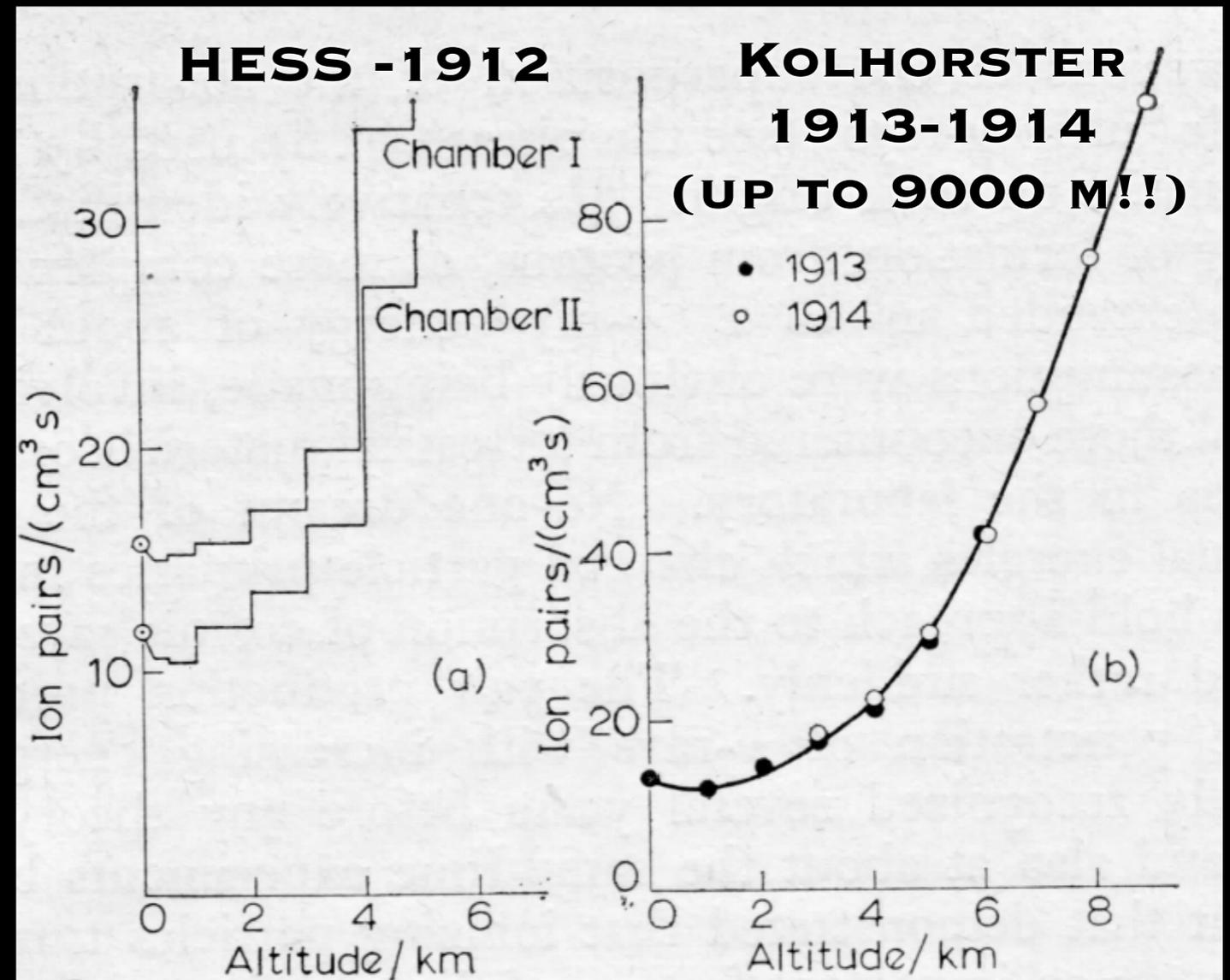

Intensity of the ionizing radiation first decreased as the balloon went up and then increased

*“The only possible way of interpret my findings was to conclude to the existence of a hitherto unknown and very penetrating radiation, coming from above and probably of extra-terrestrial origin” [V. Hess 1912]*

# The very first steps towards the discovery of EAS

*Trying to infer the nature of cosmic rays*

The discovery of cosmic rays was based on ionisation in an electroscope. Pioneering experiments (Millikan 1920s, Compton 1930s) used also ionisation chambers to study the CR variation vs altitude and altitude

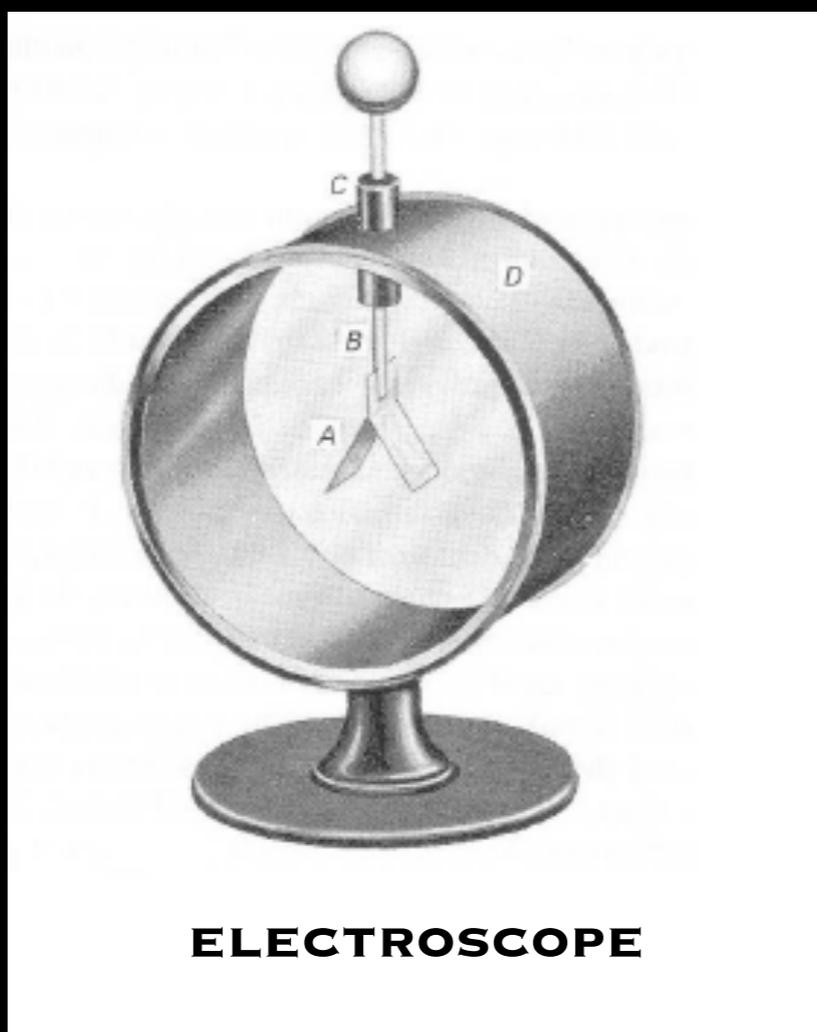

Compton's chamber was shielded by layers of lead (against local radioactivity). The central container (filled with argon) held a probe connected to high voltage)

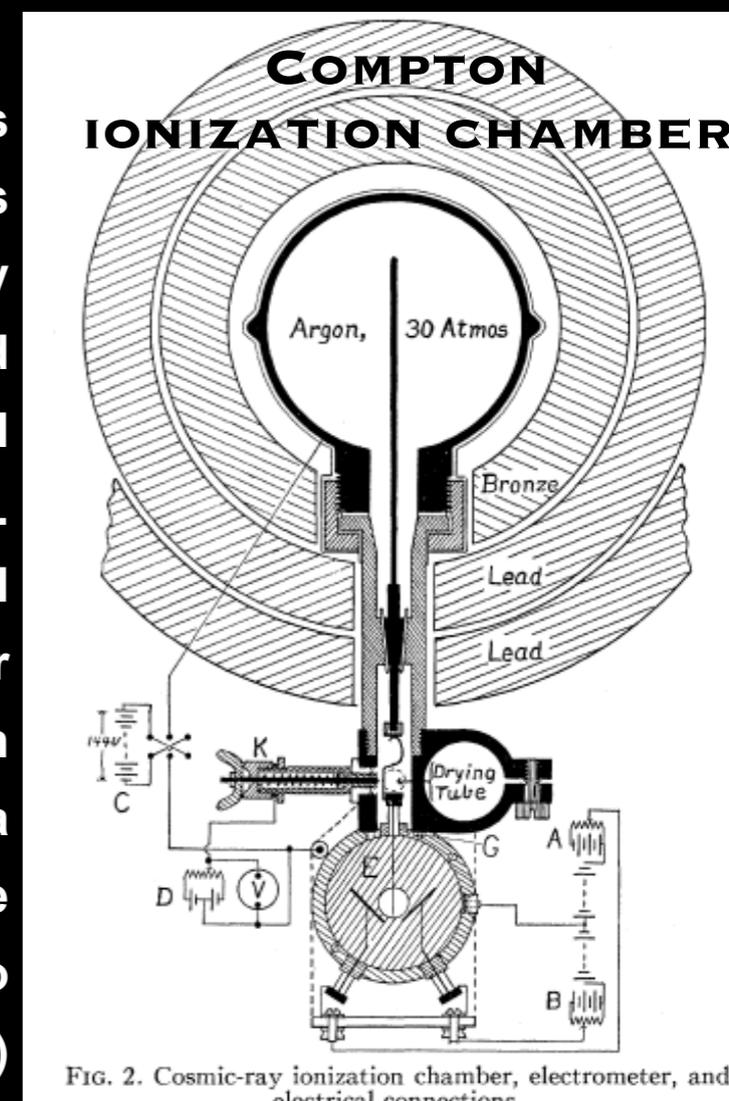

**Electroscopes and ionisation chambers can only detect the combined ionising effect of many particles. They cannot access single particles**

# The very first steps towards the discovery of EAS

*Trying to infer the nature of cosmic rays  
The first detectors of single particles*

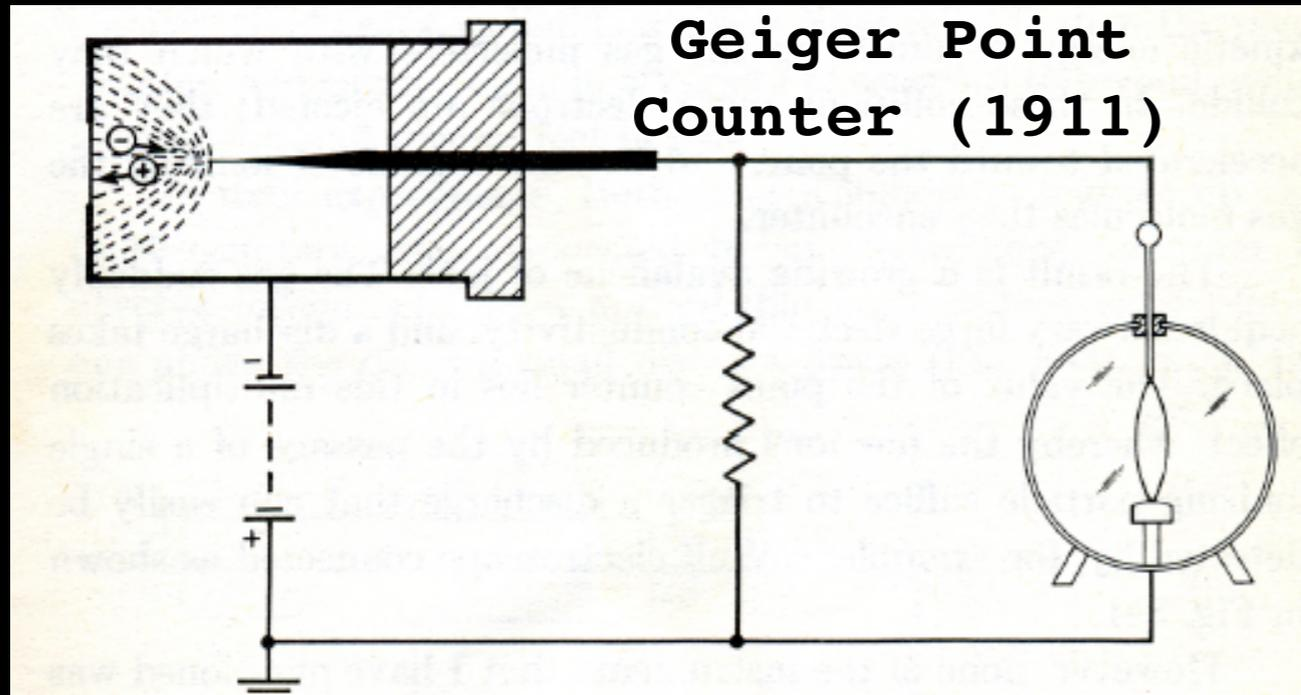

A thin point rod in a metal box filled with gas. A battery maintains the rod at positive potential with respect to the box. Particles penetrating in the box produce ionisation. Ions and electrons are accelerated: an avalanche creates a brief electrical current: the electroscope wires undergo a sudden deflection

**Not stable, not realisable in size large to counterpart the small intensity of CRs**

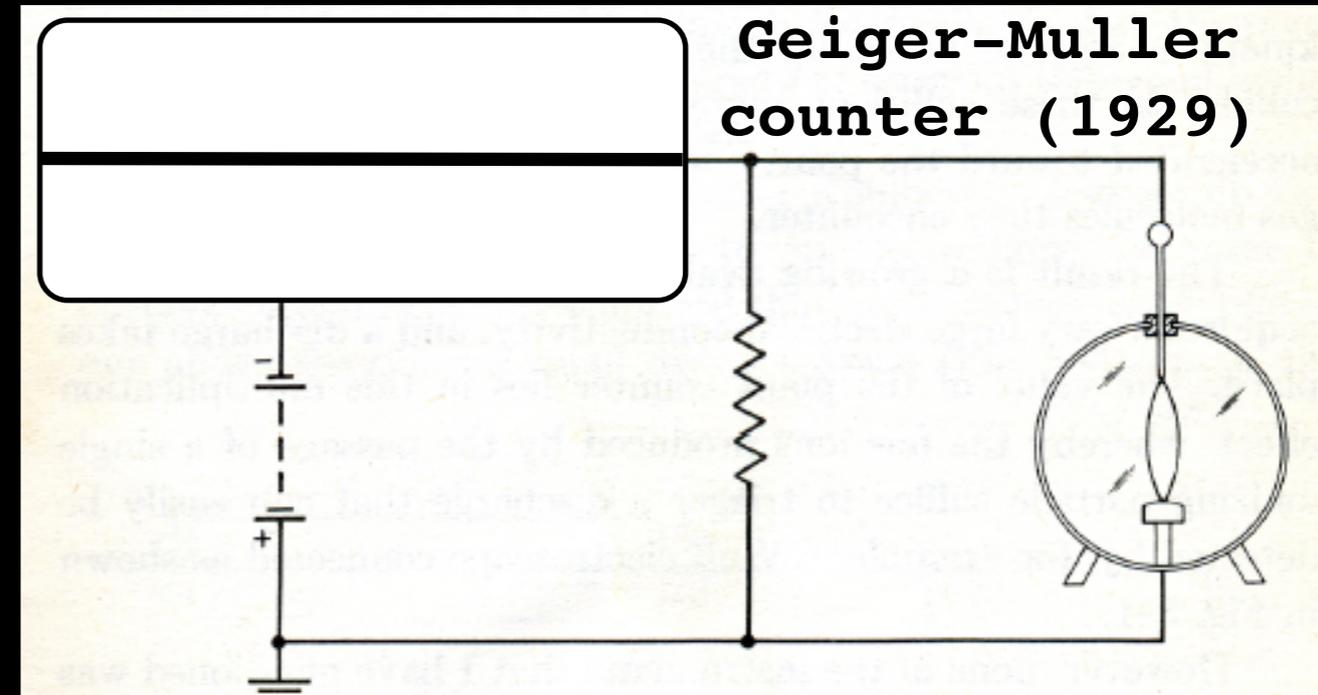

1929: the invention by Geiger and his student Muller of the so-called Geiger-Muller counter.

A metal tube filled with a gas with a thin metal wire stretched along its axis. Same principle as the point counter

Fast response time: not only individual events can be identified but also their arrival times

**Easy to build, stable and realisable in different sizes. Very much used to study CRs**

# The very first steps towards the discovery of EAS

## *The invention of counting in coincidence*

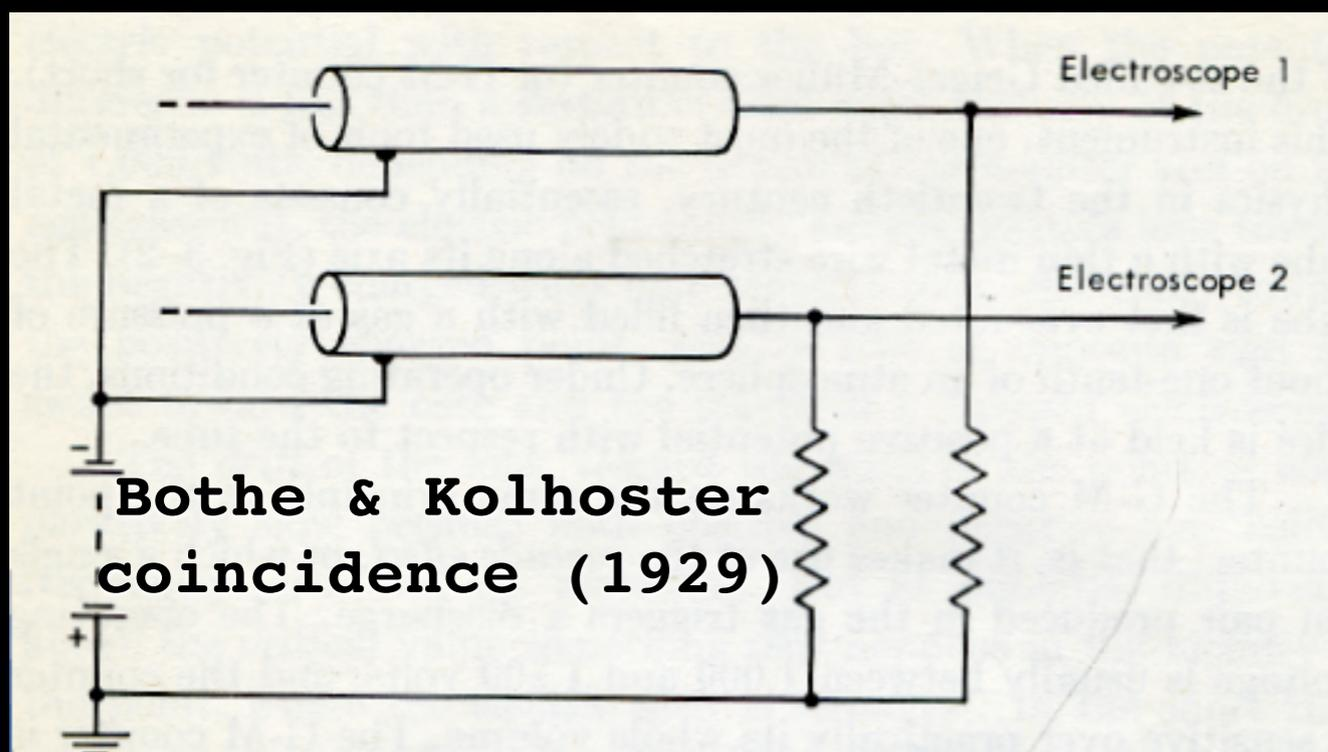

G-M counters (2 max) connected to electroscopes. When placed one above the other a small distance apart, often discharged simultaneously.

Coincidences were not by chance as they became less frequent when the distance increased. By inserting absorbers (lead, gold) between the counters (and still finding coincidences) **B&K concluded that “a corpuscular radiation was detected...unlikely to be a gamma-radiation...”**

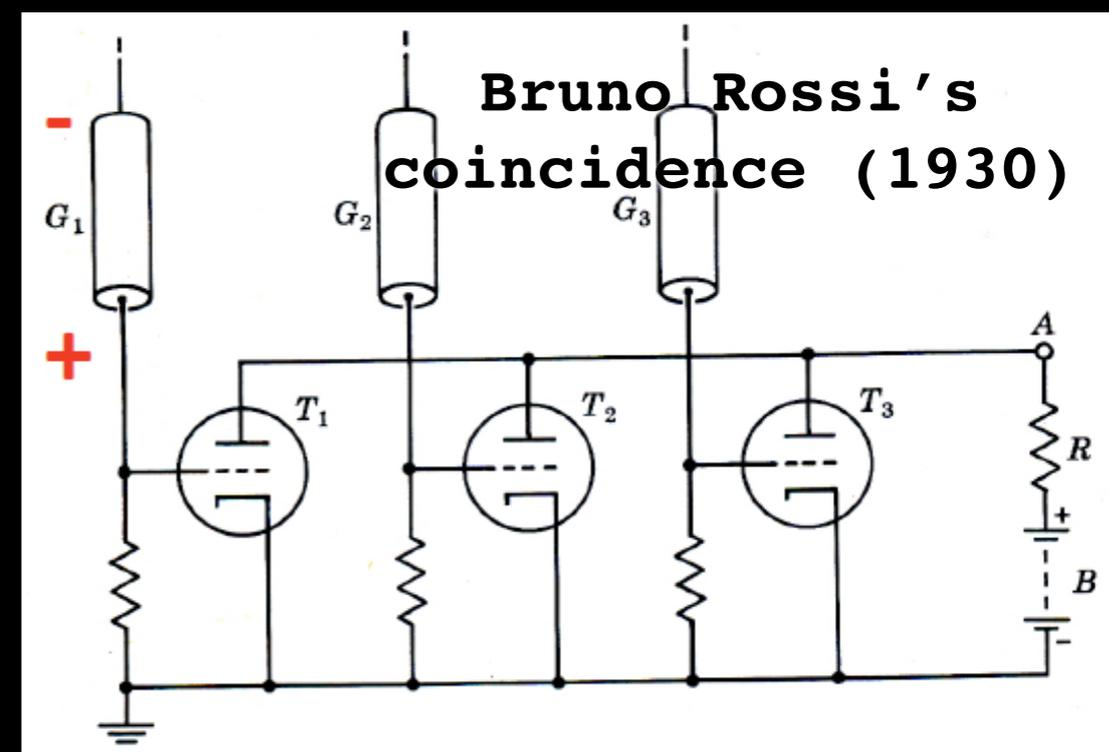

2 or more triodes coupled to G-M counters. When the grids were simultaneously driven to a negative potential by the coincident discharges of the 3 counters, a pulse appear at the plates.

**Bruno Rossi (1930) much improved the method by B&K obtaining a better time resolution, and extending the coincidence to more than 2 counters**

# The very first steps towards the discovery of EAS

## *The invention of counting in coincidence and the very first hint of EAS*

After working with Rossi, Occhialini joined Blackett in UK, where he applied Rossi's coincidence logic to Blackett's cloud chamber. The counter-controlled cloud chamber was born (1933)

A CR particle passing through two G-M counters (placed above and below the chamber) and the chamber produces a coincidence. The signal from the coincidence triggers the expansion of the chamber in time with the ions formation.

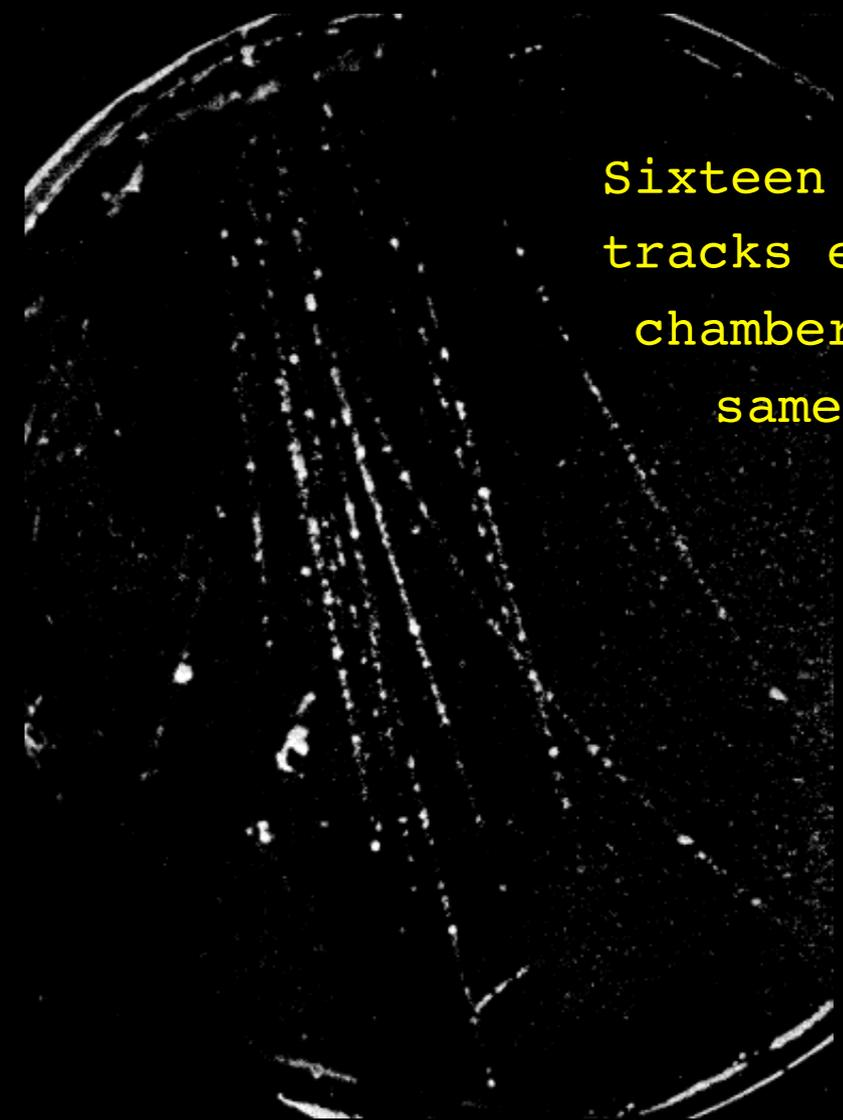
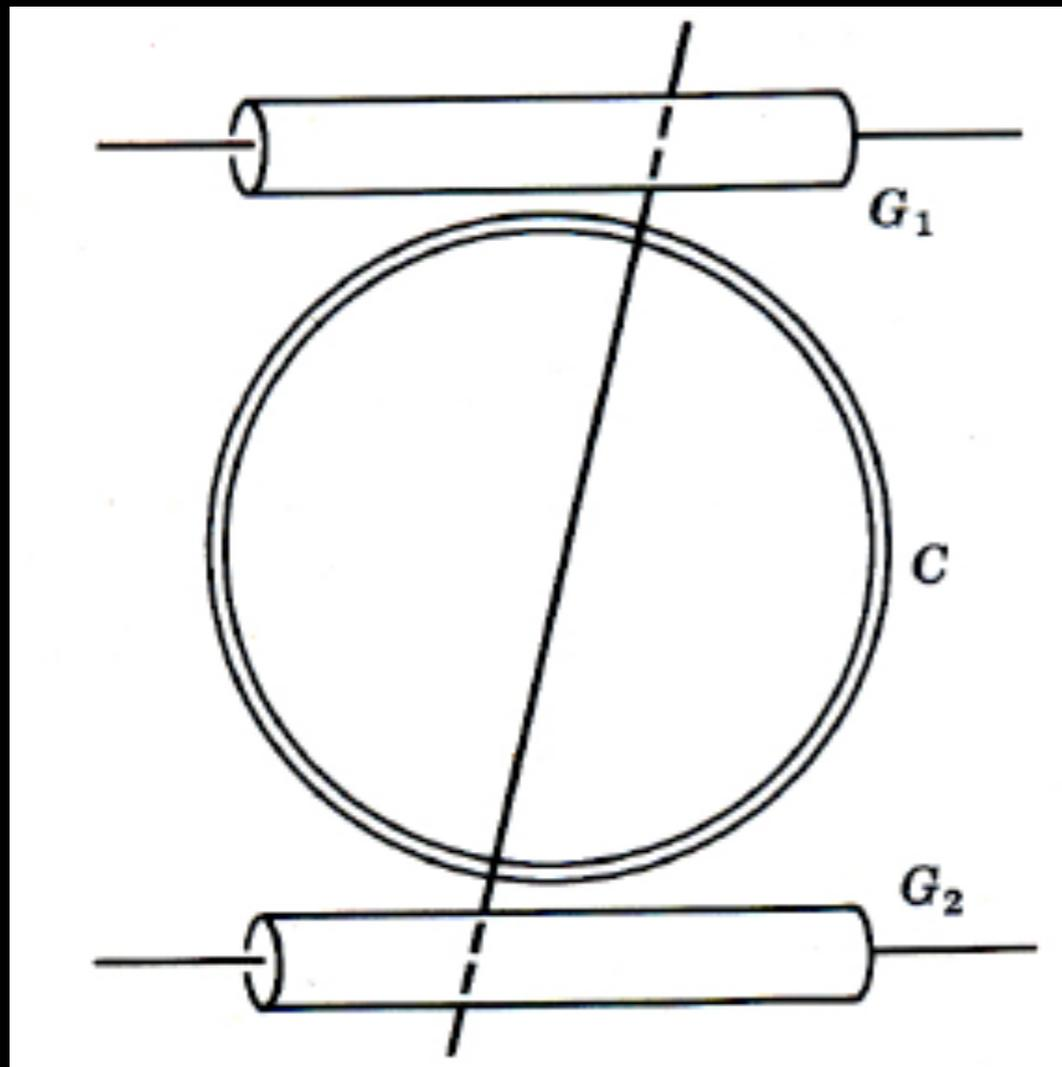

Sixteen separate tracks enter the chamber at the same time

With their new cloud chamber, in 1933 Blackett and Occhialini observed tracks of many particles that clearly resulted from the interaction of a single high-energy cosmic ray near the chamber. The discovery of these “showers” marked another milestone in CR research.

# The serendipitous observation of “sciami estesi”

## *The first observation of “sciami estesi”*

**‘It would seem . . . that from time to time there arrives upon the equipment very extensive group of particles (‘sciami molto estesi di corpuscoli’) which produce coincidences between counters even rather distant from each other’**

**Bruno Rossi, 1934**

Rossi placed three Geiger counters in a triangular array, i.e., they could not be discharged by a single particle traveling in straight line. Yet, even when surrounded by lead, the array recorded coincidences. The coincidence rate fell ALMOST to zero when the upper lead was removed. The coincidences could only have been the result of two or more ionising particles emerging simultaneously from the lead. Coincidences were present also WITHOUT lead: **Rossi correctly suspected that soft secondary particles were produced by cosmic particles either in the material or not.**

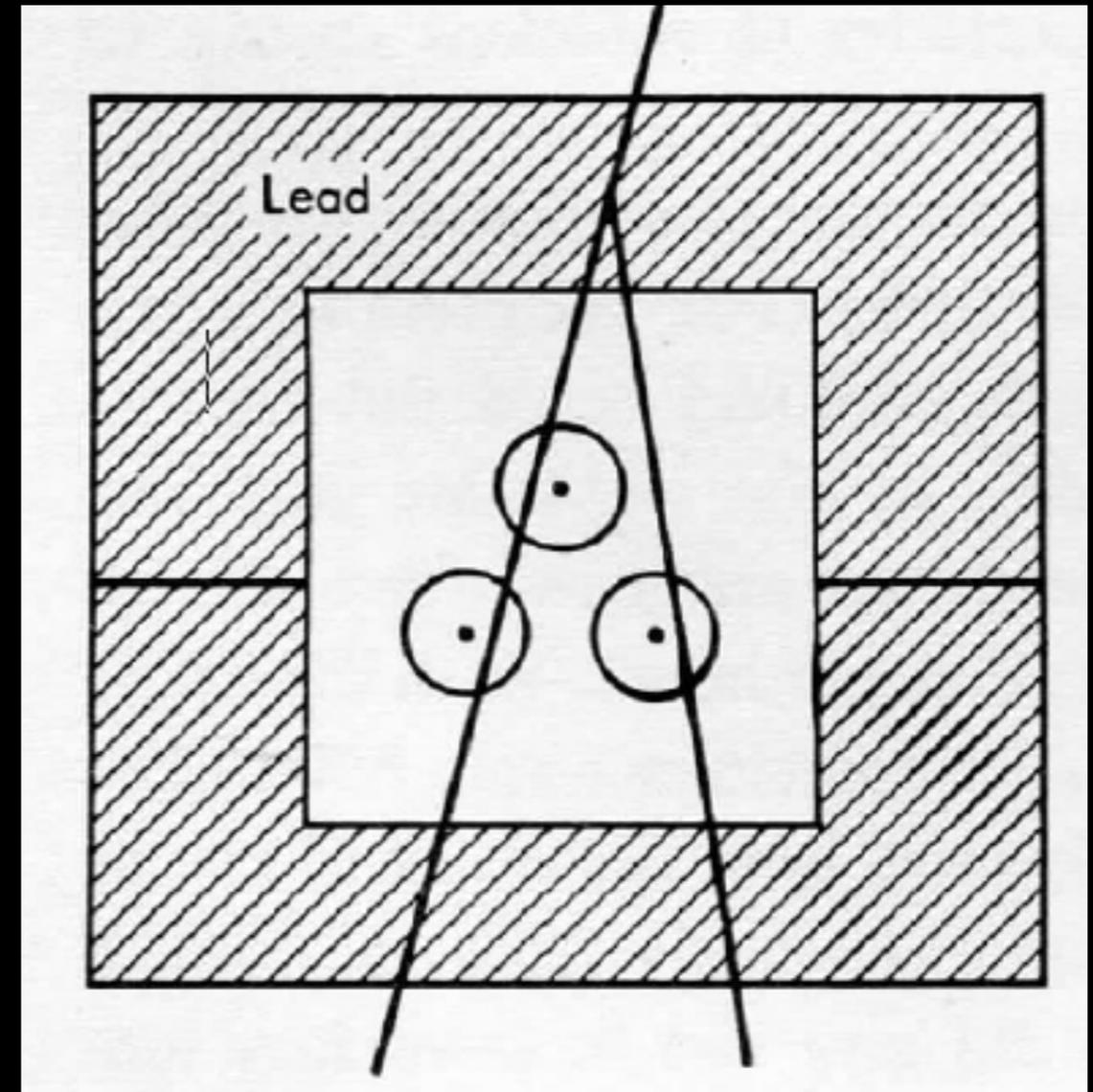



# The serendipitous observation of “sciami estesi”

## *The first observation of “sciami estesi”*

**‘It would seem . . . that from time to time there arrives upon the equipment very extensive group of particles (“sciami molto estesi di corpuscoli”) which produce coincidences between counters even rather distant from each other”**

**Bruno Rossi, 1934**

Rossi observed a rapid increase of triple coincidences in a triangular arrangement of Geiger counters when some centimetres of lead was placed above. Only with further increasing absorber thickness did the coincidence rate start to decline. Rossi correctly concluded that soft secondary particles were produced by cosmic particles entering the material. These secondary particles then suffer increasing absorption with increasing total thickness of the absorber.

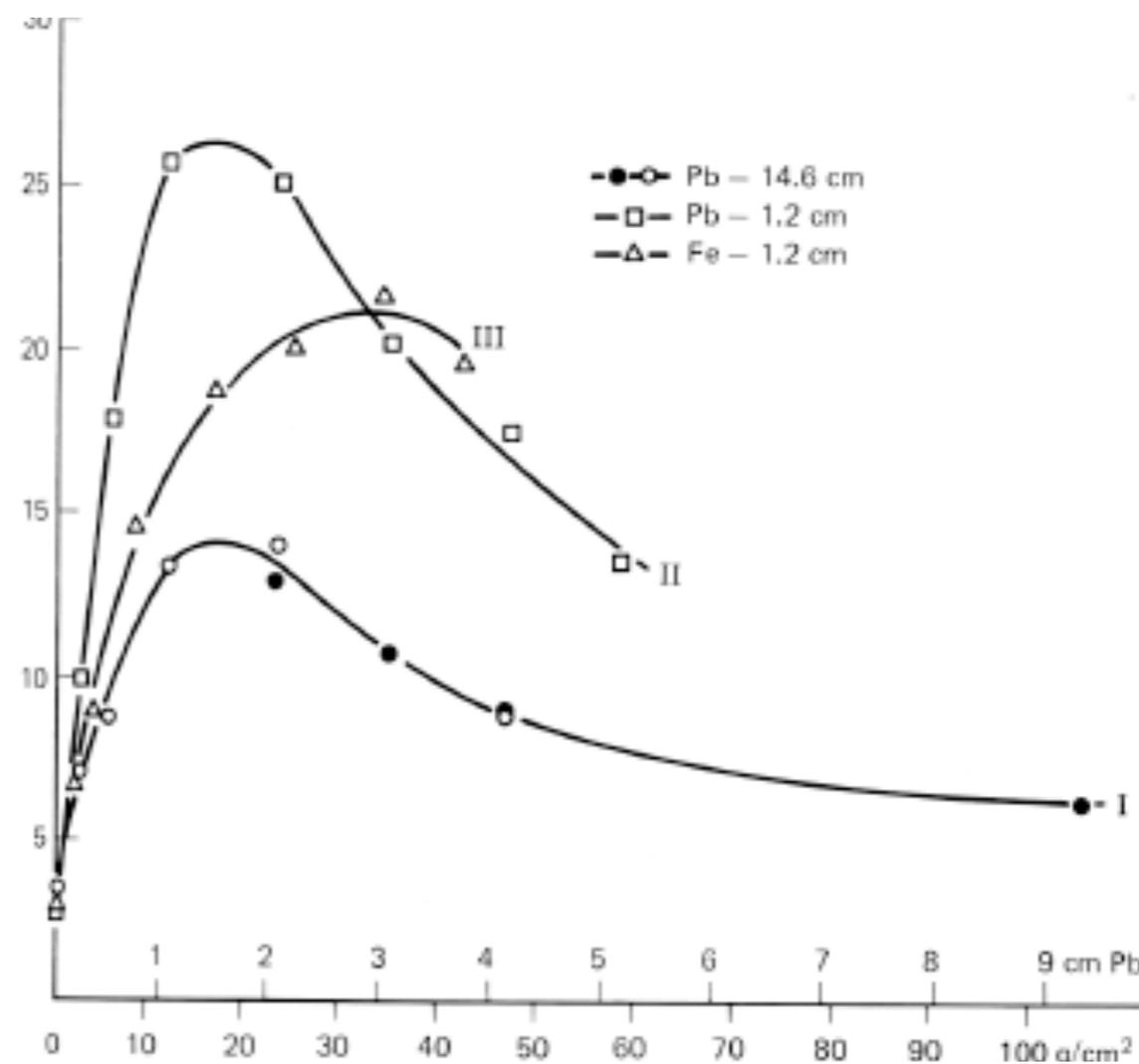

**Rossi's transition curves. The curves I-III refer to measurements with Pb and Fe absorbers placed at distances above the counters**

# The discovery of Extensive Air Showers

*Schmeiser & Bothe, Kolhörster, and PIERRE AUGER*

**Schmeiser and Bothe pointed out that Rossi's observations implied the occurrence of showers in air and showed that particles in air showers had separations up to 40 cm. Independently, Kolhörster et al. reported data on the rate at which coincidences between a pair of Geiger counters fell as a function of separation**

Despite the work of Rossi and the two German groups, credit for the discovery of extensive air showers is usually given to Pierre Auger. His observation depended on the electronic developments by Roland Maze who improved the resolving time of coincidences. They found that the chance rate between two counters separated by some distance greatly exceeded the chance rate expected from the resolving time of the new circuit. They estimated an energy of about  $\approx 10^{15}$  eV for the primary particle!!!

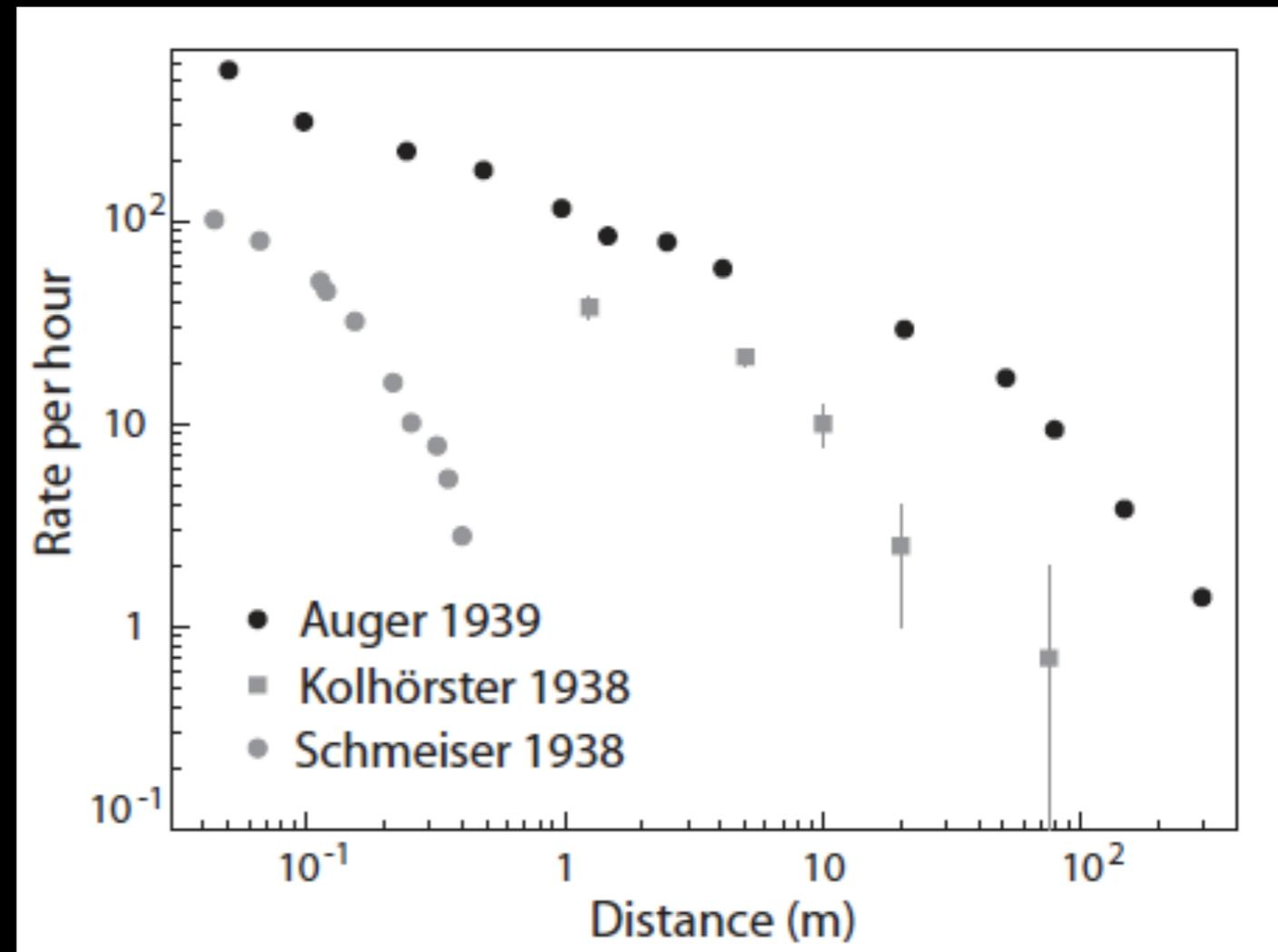

*The discovery of extensive air showers:  
Decoherence curves measured with Geiger  
counters separated up to 300 m distance.*

# Towards understanding Extensive Air Showers

1940s - 1950s

Several groups, including Auger's, verified the inferences drawn from the Geiger counter observations using cloud chambers.

Work by Auger and his colleagues using cloud chambers triggered by Geiger counters allowed features of EAS to be understood relatively quickly.

By the late 1930s it was known that air showers contained hadronic particles, muons and electrons. Major advances in understanding took place in the late 1940s and early 1950s after the existence of two charged and one neutral pion was established and it was recognised that muons were secondary to charged pions.

**The features visible in this photograph, except for scale, are extremely similar to those present when a high-energy particle enters the earth's atmosphere and creates a shower.**

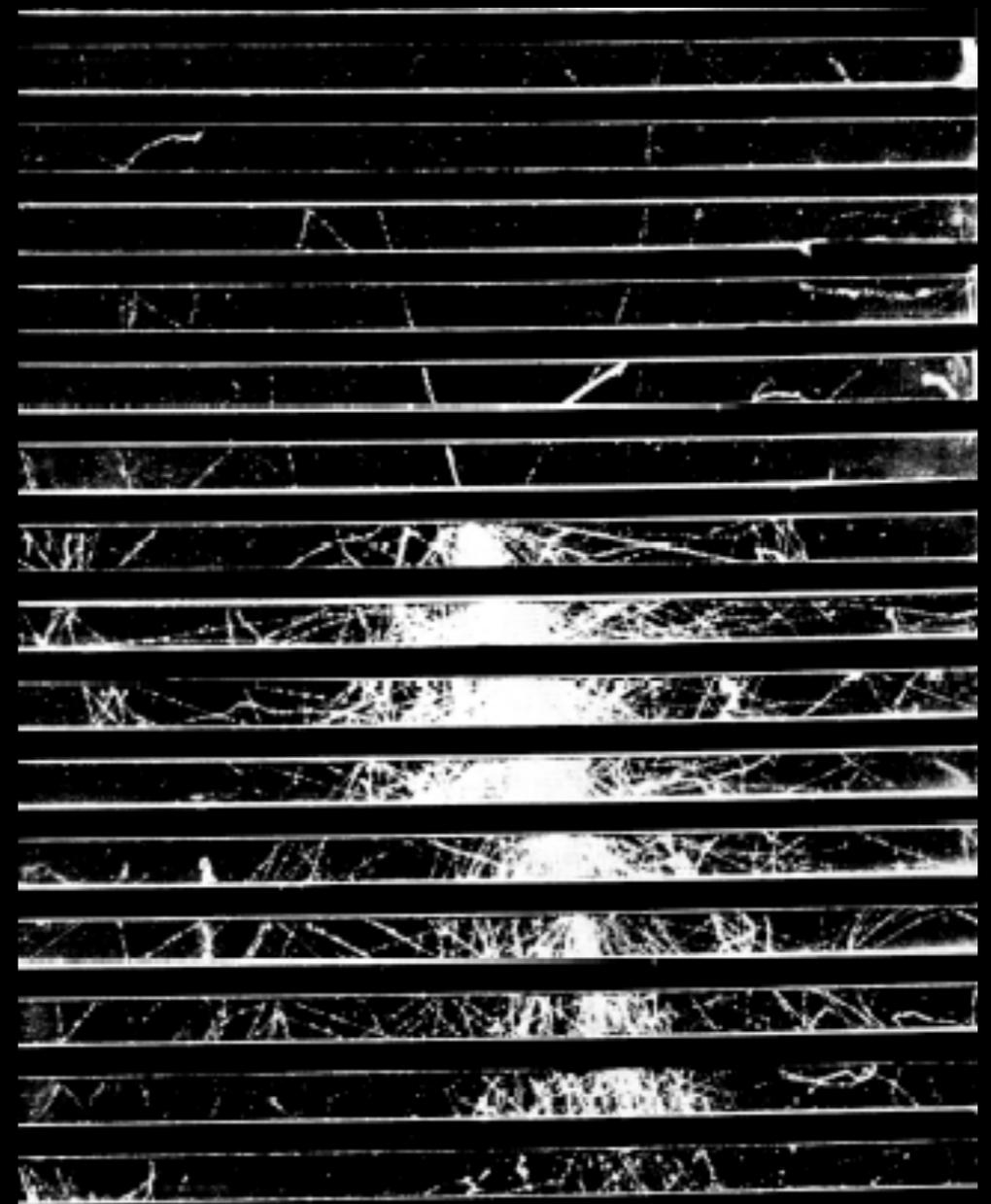

Image of a shower, as seen in a cloud chamber at 3027 m altitude, Fretter 1949 (primary proton of  $\approx 10^{10}$  eV)

# The very first EAS arrays

*Skobeltsyn, Zatsepin, Miller (1947), Cranshaw & Galbraith (1954)*

Up to the invention of PMTs and scintillators (after World War II, in the 1950s) progress in experimental EAS studies was done by using arrays of Geiger counters installed in the USSR and in UK



**EAS array on the Pamir mountain  
(3860 m, USSR, 1947)**

Geiger counters supplemented with ionisation chambers and cloud chambers. The birth of the very first “large” collaborations (20-30 people)

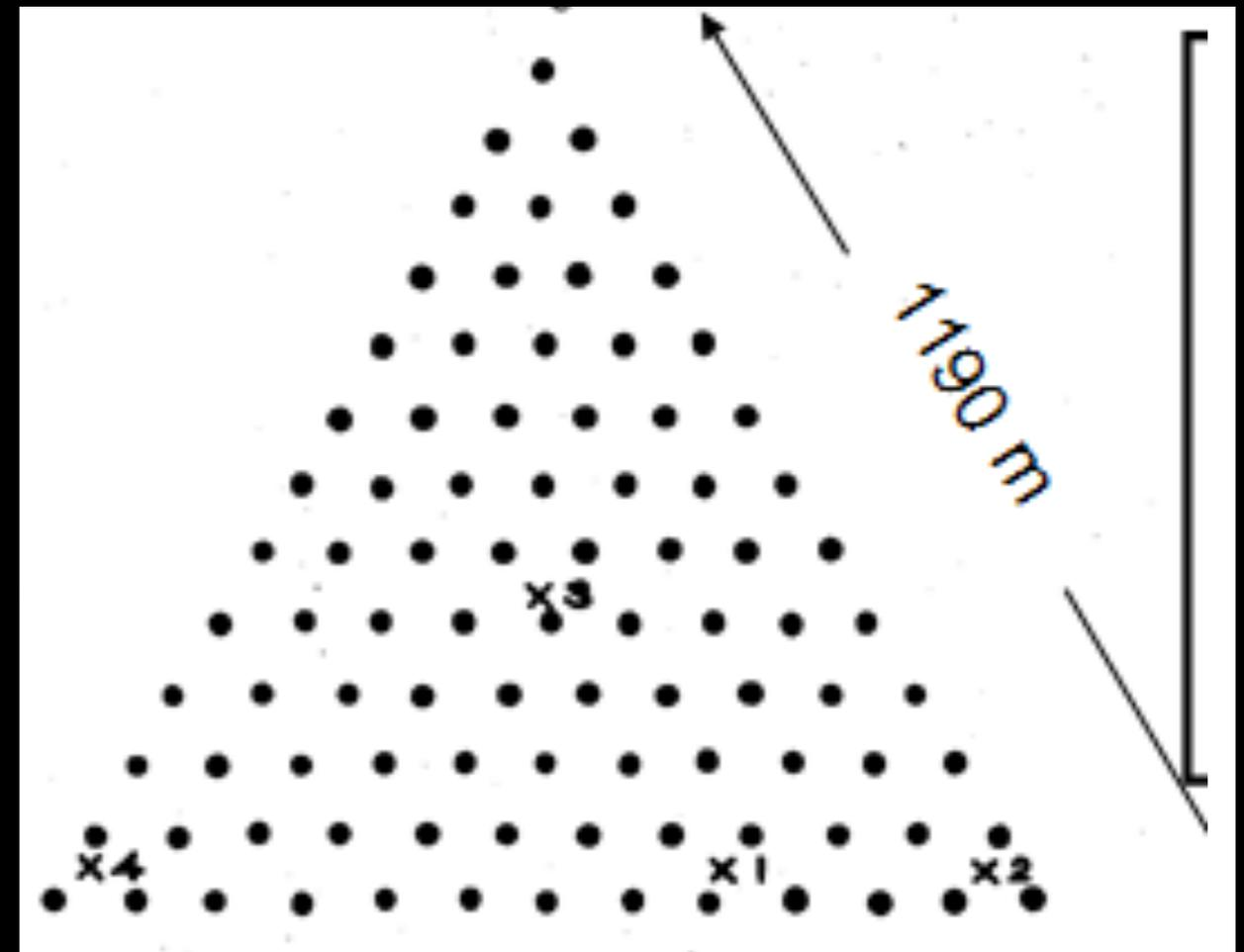

**The first “large” array (0.6 km<sup>2</sup>) at  
Culham, UK (1954)**  
91 Geiger counters spaced by 99 m.  
Hosted in a disused airfield at sea level

# ***Modern Extensive Air Shower detectors***

***(The minuteness of the phenomena -  
The adventurous excursions of the observers)***

# EAS are key to study high-energy cosmic rays

*We now know much more on the EAS features (Ralph Engel's lecture)*

**$10^{14}$  EV SIMULATED  
PROTON SHOWER**

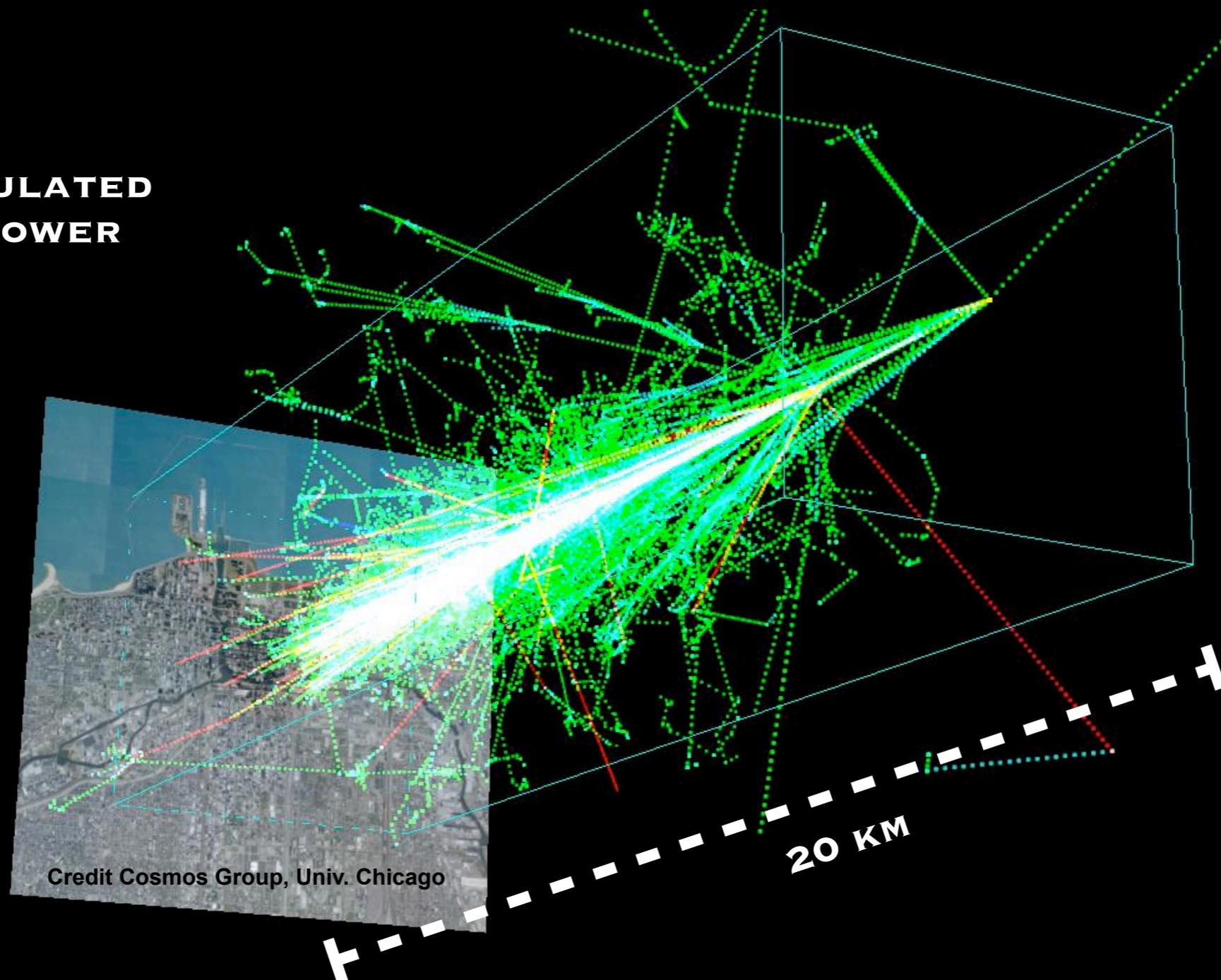

**There is no way of studying high-energy cosmic-rays other than by observing air showers. The atmosphere is used as an inhomogeneous calorimeter.**

**EAS can be detected over an extended area.**

**Large effective area of detection compensates the smallness of flux**

# EAS are key to study high-energy cosmic rays

A high energy primary particle, upon entering the atmosphere, initiates a chain of nuclear interactions

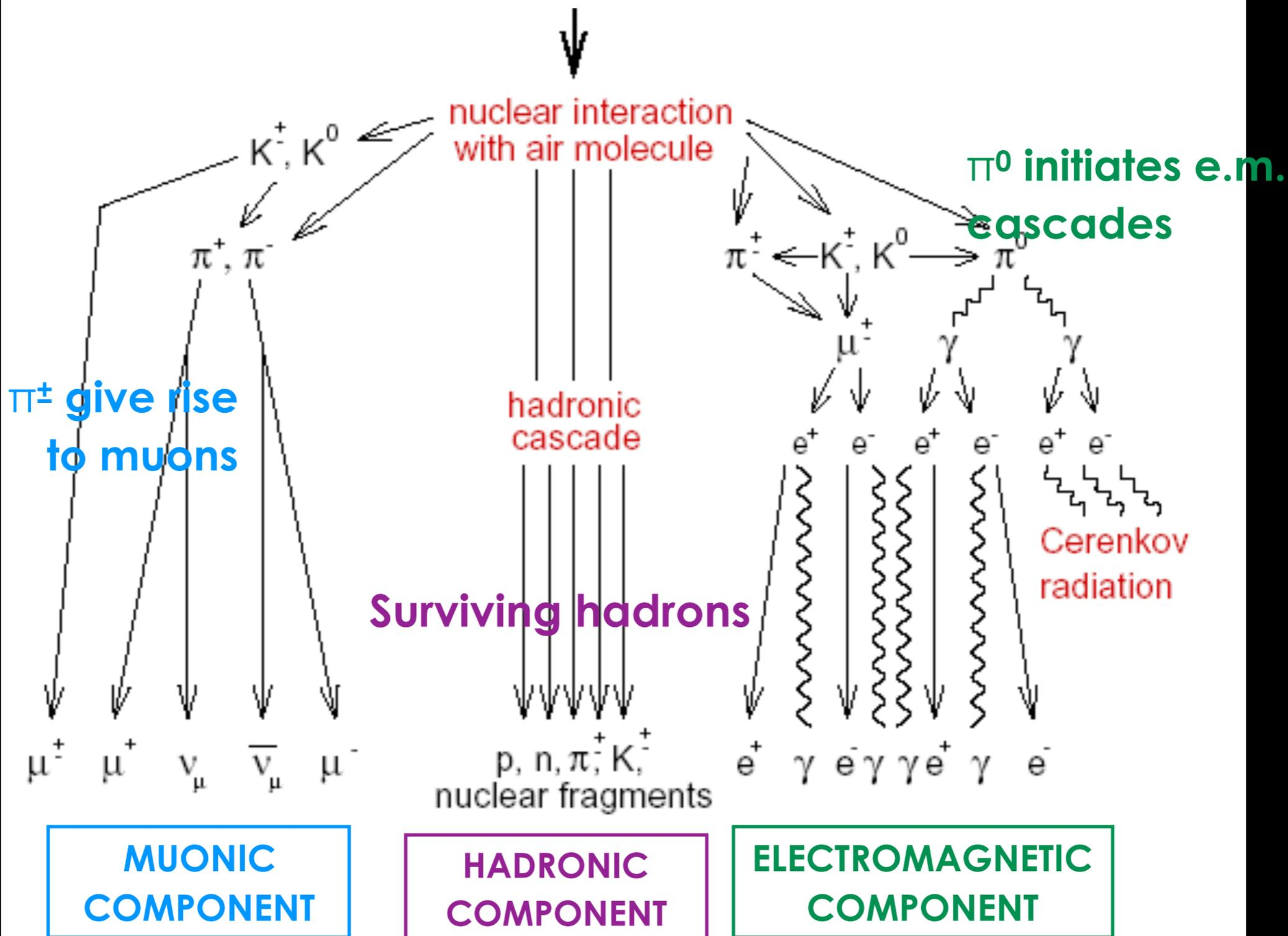

# Extensive air showers lateral development

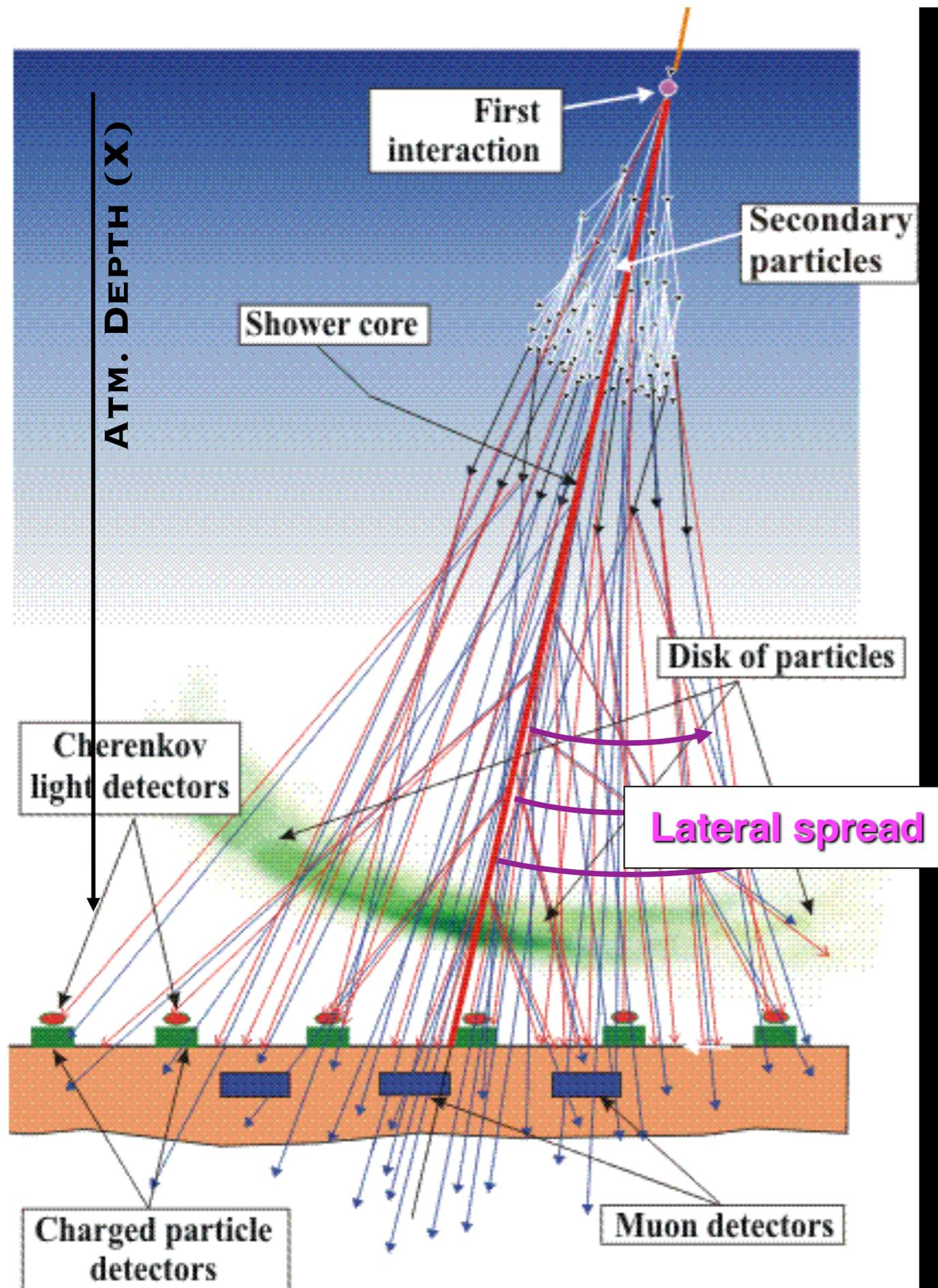

Secondary particles form a narrow “bundle”: **the shower core**

Initial transverse momentum and multiple scattering in atmosphere causes particles **to spread out laterally** from the core -> **lateral distribution**: particle density is greater in the core and it decreases with increasing distance from it

Due to different path lengths and velocities across the atmosphere shower particles are distributed over a wide area in a **thin curved disk**



# Extensive air showers longitudinal development

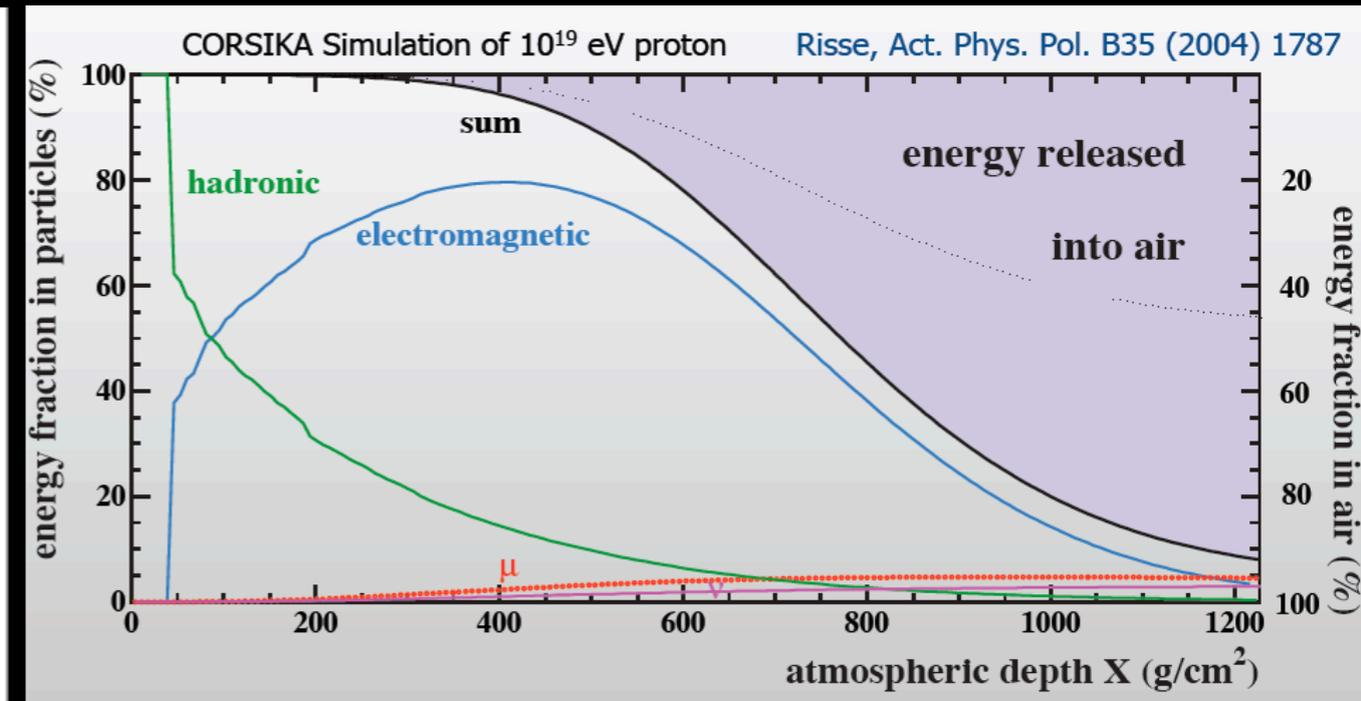
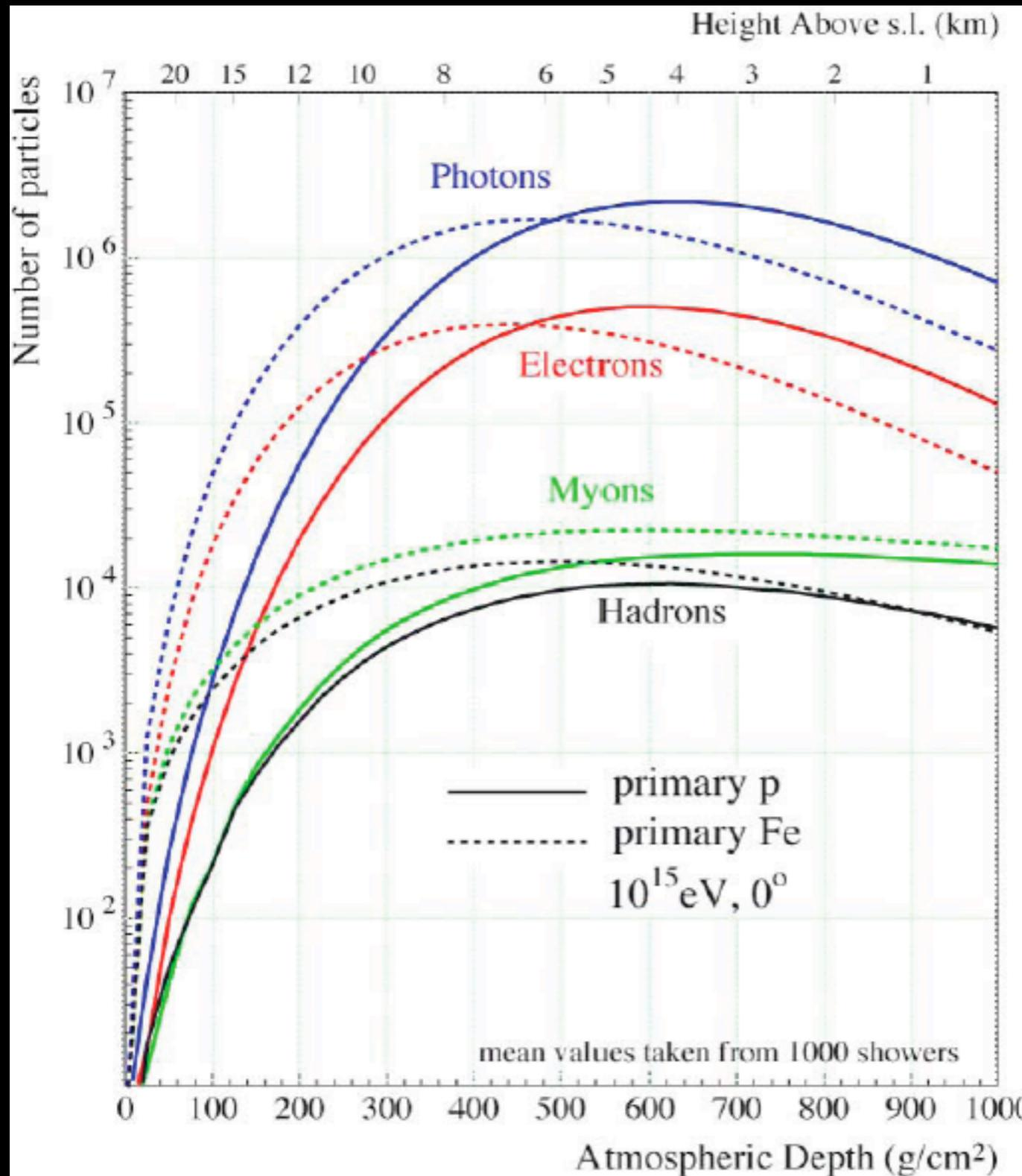

90% of the primary energy of the cosmic ray is dissipated in the atmosphere during shower development

The number of particles increases with atmospheric depth, reaches a maximum and then decreases (electrons attenuates more rapidly than muons)

# For example: a shower produced by a CR of $10^{19}$ eV...

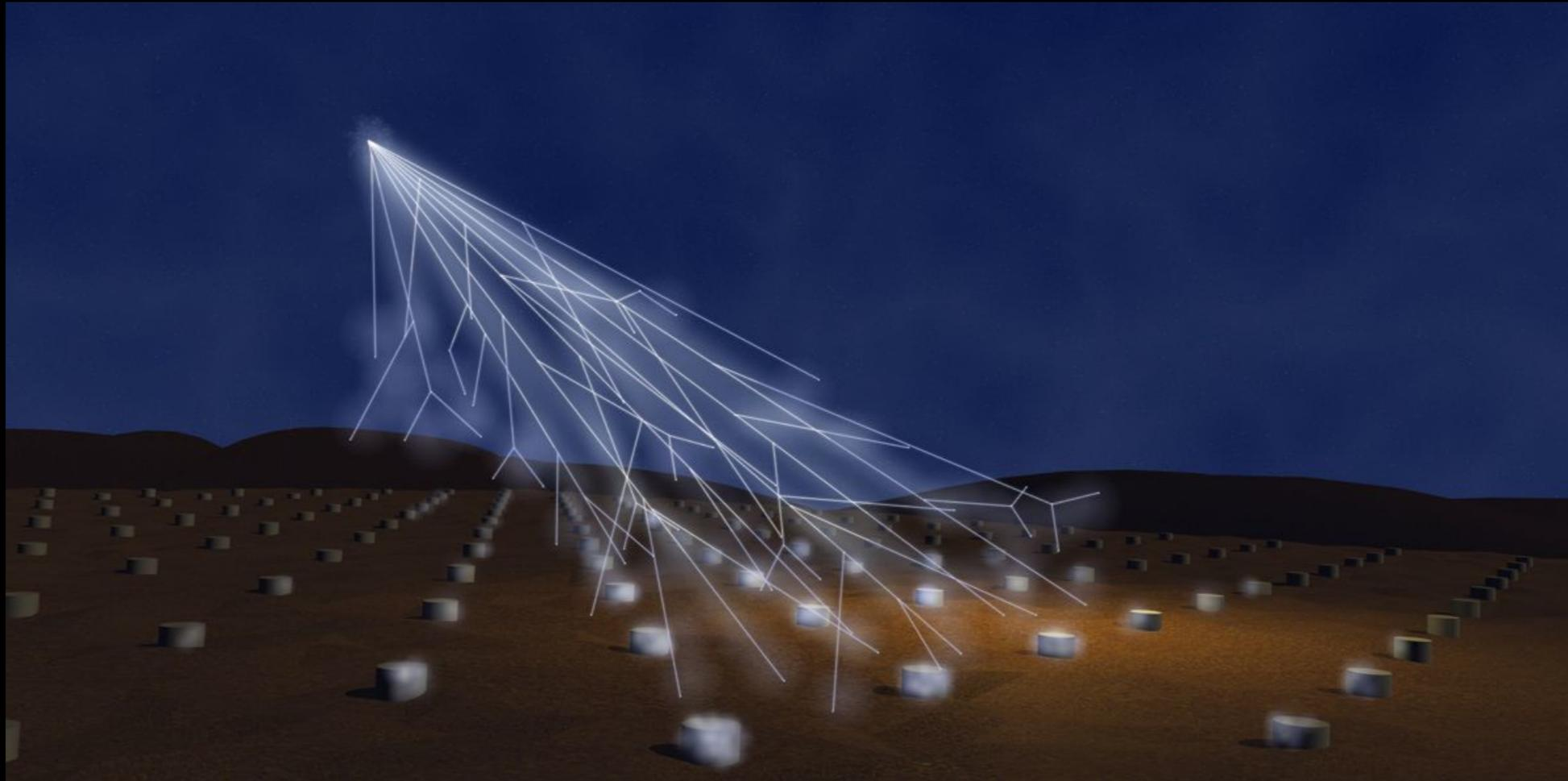

- Contains about  $10^{10}$  particles at the maximum
- Consists mostly of electromagnetic particles, with about 10% muons.  
Hadronic particles are a very small fraction
  - Has the maximum at about 3 km above sea level
- Has a footprint at ground that can extend up to over 15 km
  - Has a thickness that can be a few hundreds meters  
(depending on the distance from the core)

# Particle detectors

## *Scintillators and photomultipliers (PMTs)*

Scintillation detectors are historical devices. Rutherford used a scintillating zinc-sulphide screen to count alpha-particles (Crookes tubes). Photons were looked at by eye (by microscopes in darkened rooms). Their use was boosted by the invention of PMTs.

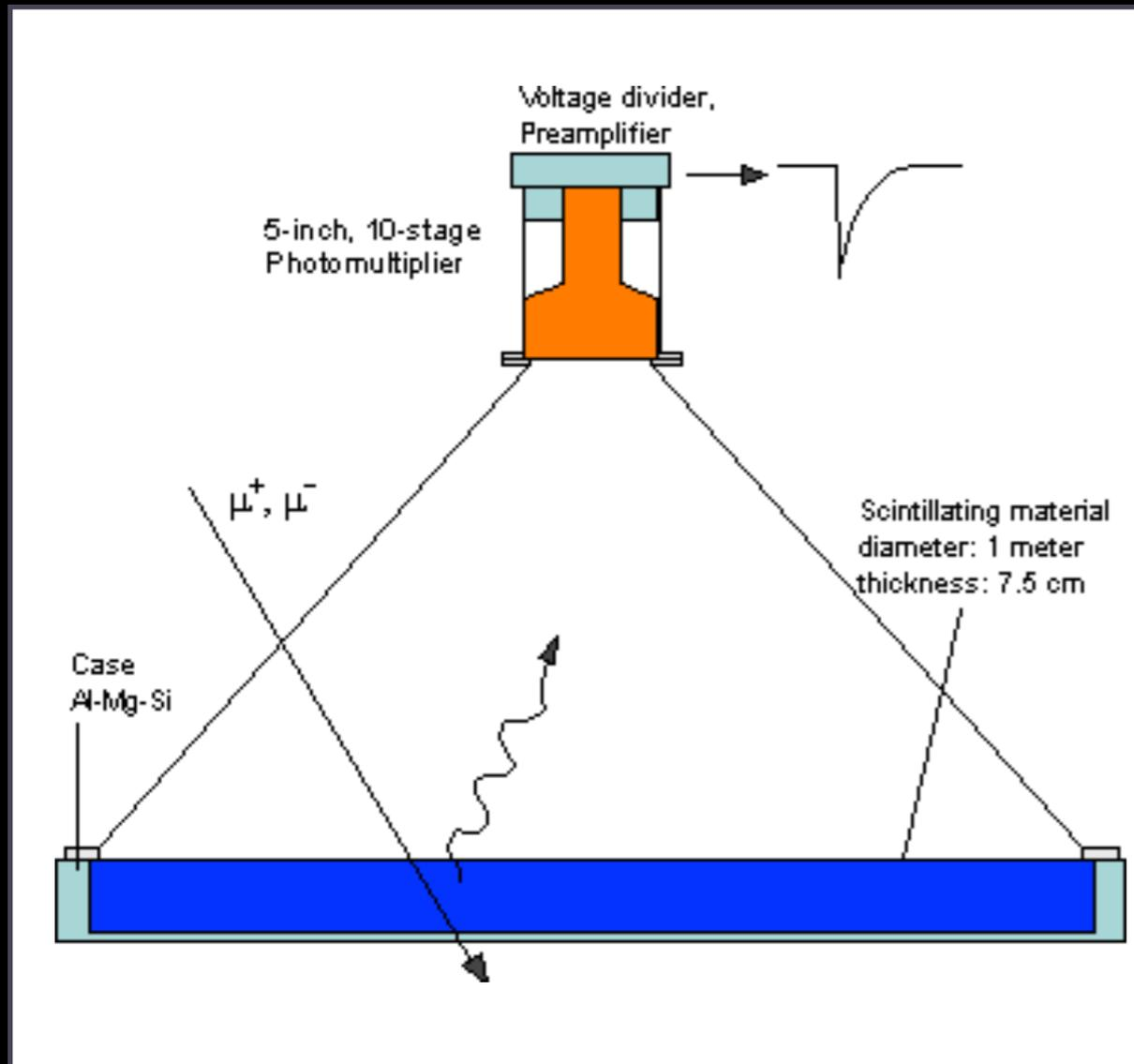

**The first scintillator counter was invented in 1944 within the Manhattan Project**

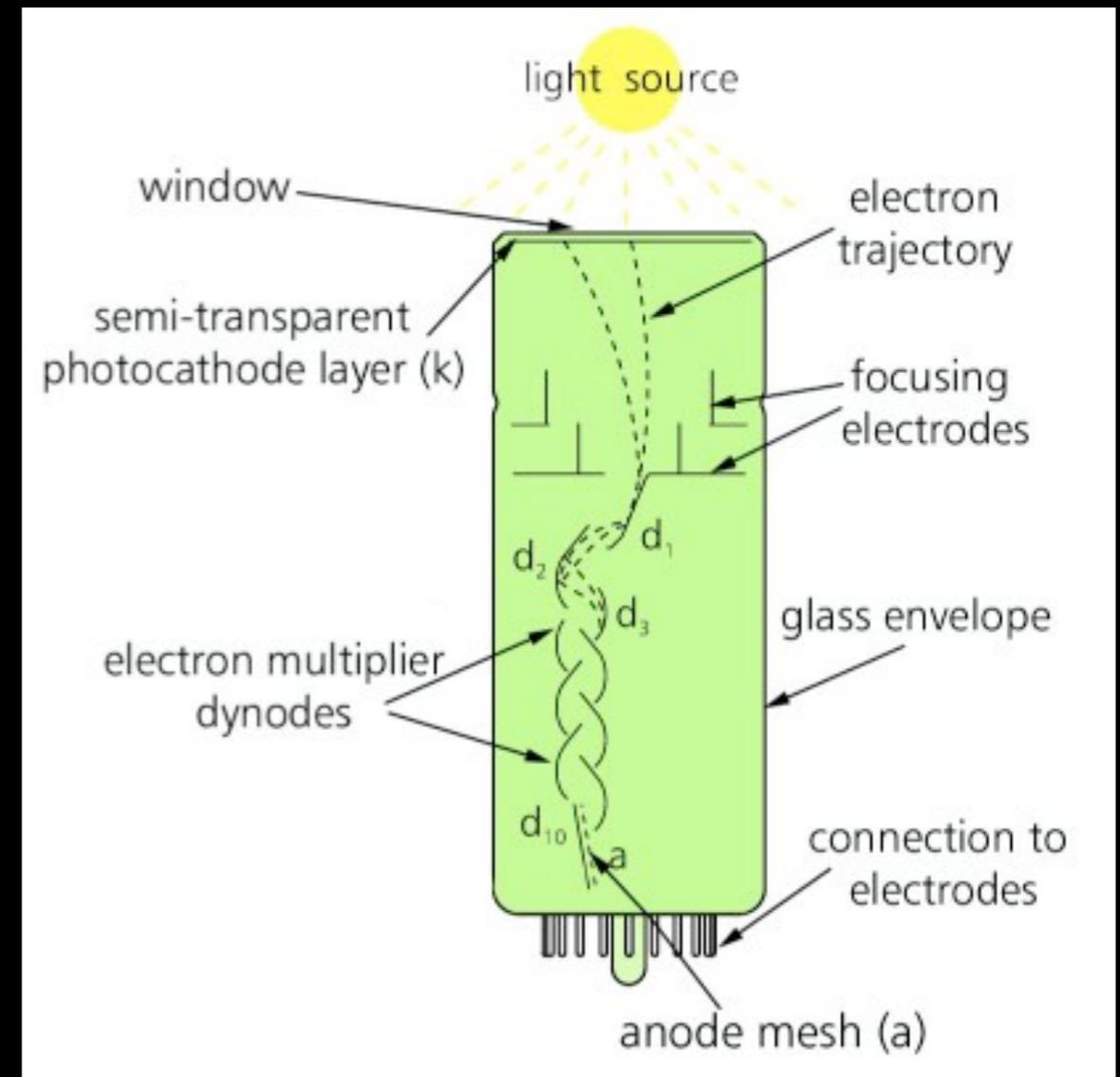

**Photomultiplier tubes were developed in mid 40s (after World War II)**

# Particle detectors

## *Water Cherenkov detectors*

**When a particle moves through a medium at a velocity greater than  $c$ , it emits Cherenkov radiation (Cherenkov, Frank, Tamm, 1933).**

**[N.B. In Russia, the radiation is called Vavilov-Cherenkov radiation (Vavilov was Cherenkov's director)]**

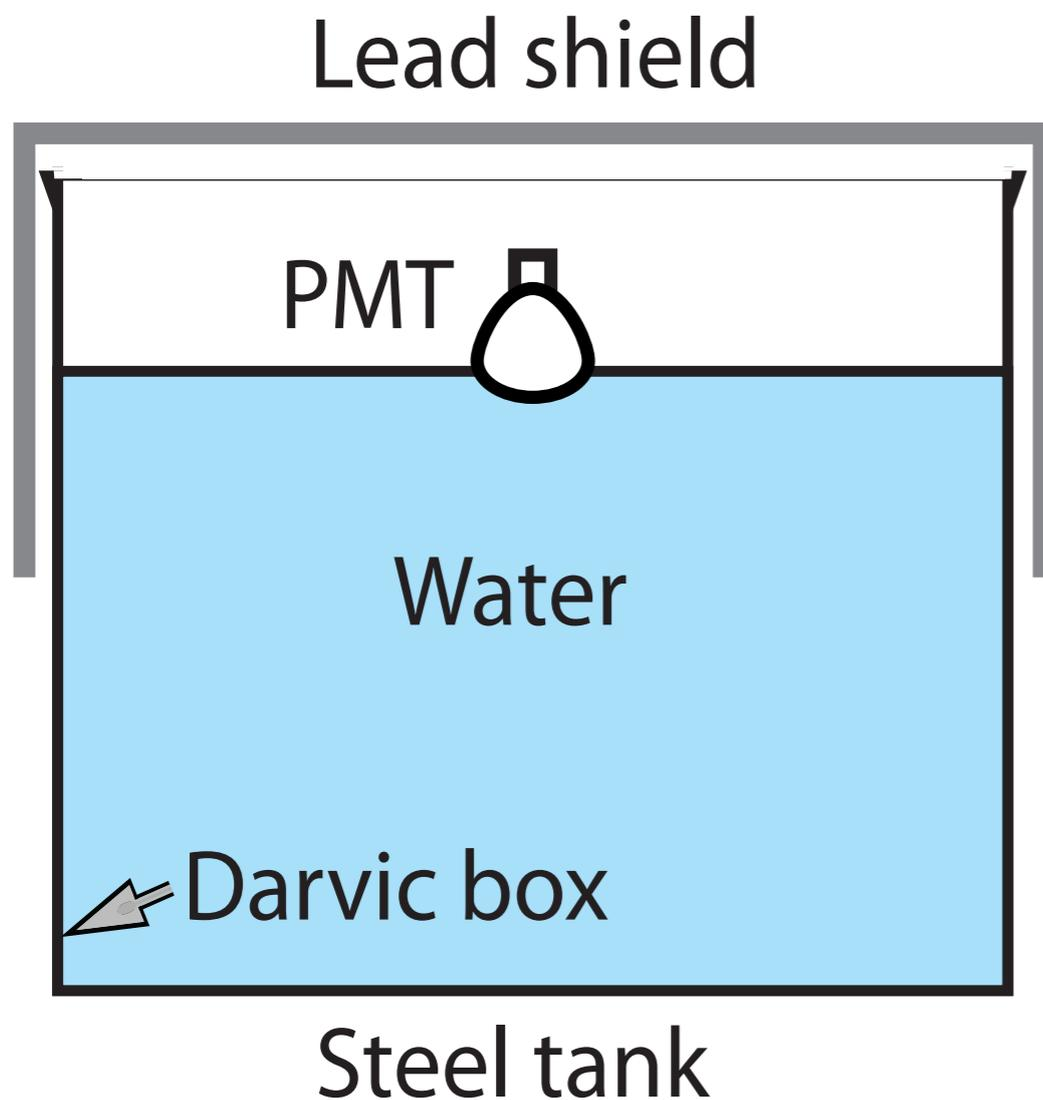

Detectors of Cherenkov light produced in water.

First developed at Culham UK (Porter, 1958). It used a box of Darvic, a material used for sandwich boxes containing an inhibitor of bacterial growth. This allowed to prevent bacterial growth in unfiltered water and realise a stable detector.

**Scheme of the first WCD.**

**Depth water = 92 cm, area = 1.44 m<sup>2</sup>**

# EAS: not only particles but also radiation

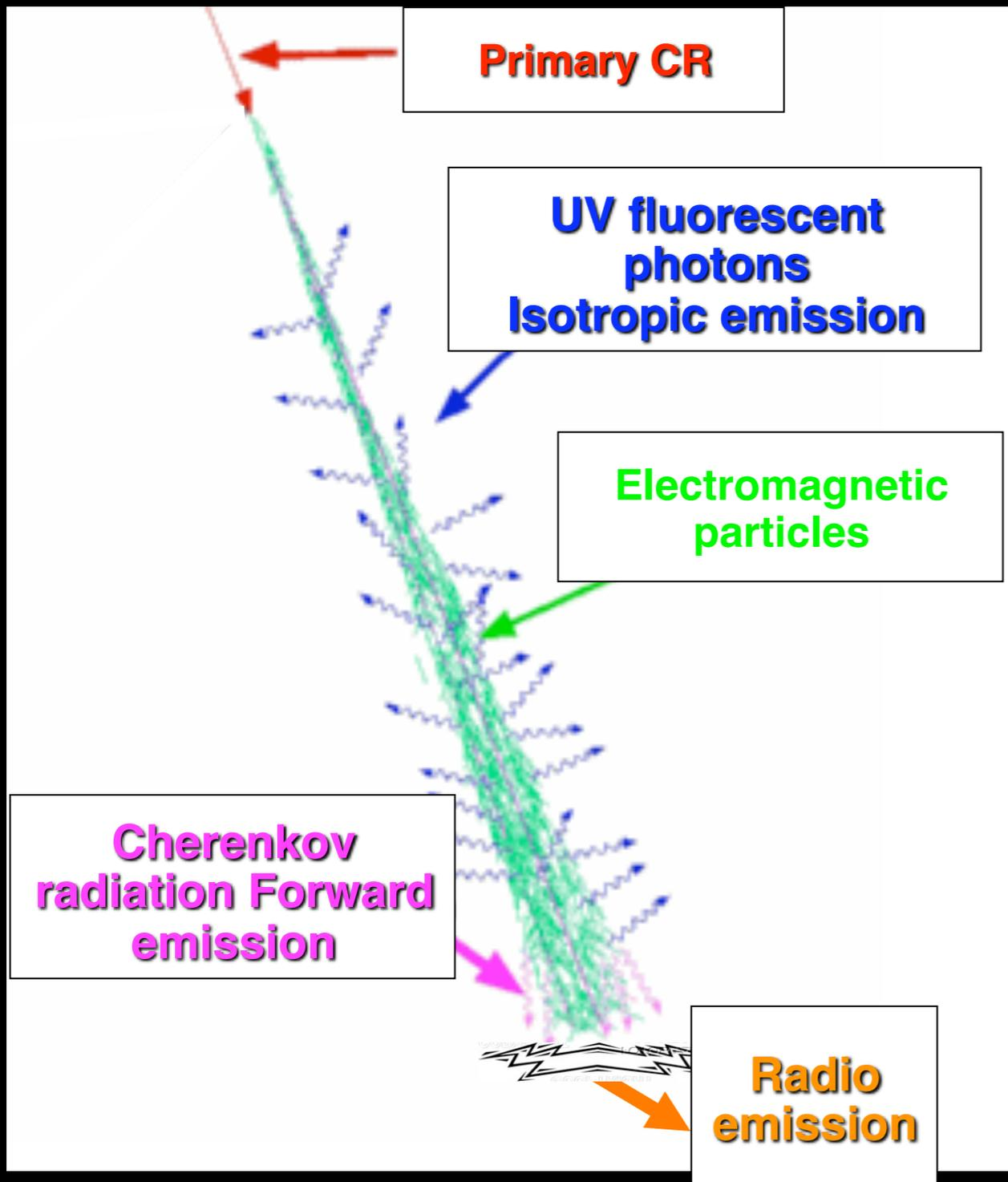

**Cherenkov radiation:** Electrons and positrons in the shower travel faster than the speed of light in air and emit Cherenkov radiation, mostly in the forward direction

**Fluorescence radiation:** The passage of air shower e.m. particles in atmosphere results in the excitation of nitrogen molecules. Some of this excitation energy is emitted in the form of isotropic visible and UV radiation.

**Radio emission:** Main mechanisms: air shower electrons and positrons acceleration in the Earth's magnetic field. Also, radio-emission from the time-varying negative excess in the shower. Forward-beamed radiation.

# Cherenkov radiation

*Nani gigantum humeris insidentes (Blackett, Galbraith, Jelley)*

**When a particle moves through a medium at a velocity greater than  $c$ , it emits Cherenkov radiation (Cherenkov, Frank, Tamm, 1933).**

**[N.B. In Russia, the radiation is called Vavilov-Cherenkov radiation (Vavilov was Cherenkov's director)]**

In 1948, Blackett was the first to discuss Cherenkov radiation in air concluding that CR showers should produce a flash of light that one should be able to see lying down and looking upwards under dark sky conditions, an investigation which Blackett carried out himself. The outcome of his "experiment" is unknown.

**Soon after PMTs were invented, and used to detect Cherenkov light produced by showers (Galbraith and Kelley, 1952).**

**The technique has a low duty cycle (cloudless, moonless nights)**

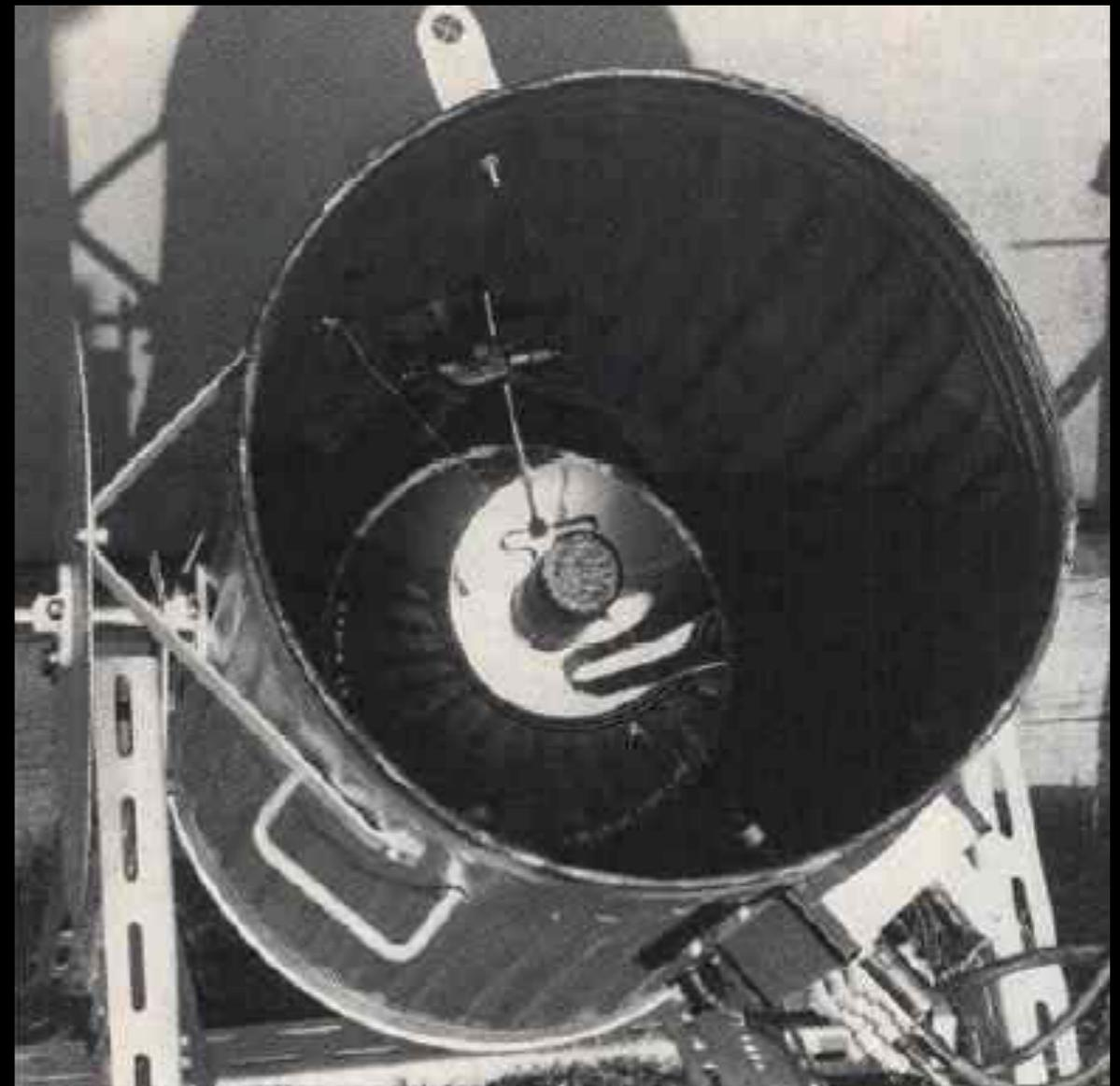

**Galbraith, Kelley (1952): Cherenkov light experiment in a garbage can**

# Fluorescence radiation

*Nani gigantum humeris insidentes: Suga, Chudakov, Greisen (1960s)*

Charged particles from EAS interact with Nitrogen molecules in air. Nitrogen molecules (1N and 2P bands) get excited and they emit (when returning to their ground state) a radiation in the wavelength range between 300 nm to 400 nm.

The fluorescence yield at 300-400 nm is approx. 4-5 photons per particle per meter of track in the atmosphere.

This fluorescence light is emitted isotropically. It can travel several km in atmosphere and be detected by optical telescopes, i.e., mirrors and PMTs equipped with fast electronics.

**Only  $\approx 0.5\%$  of  $dE/dX$  goes into fluorescence. This technique can be exploited only at UHE (above  $10^{17}$  eV). It has a low duty cycle (cloudless, moonless nights)**

Fluorescence spectrum

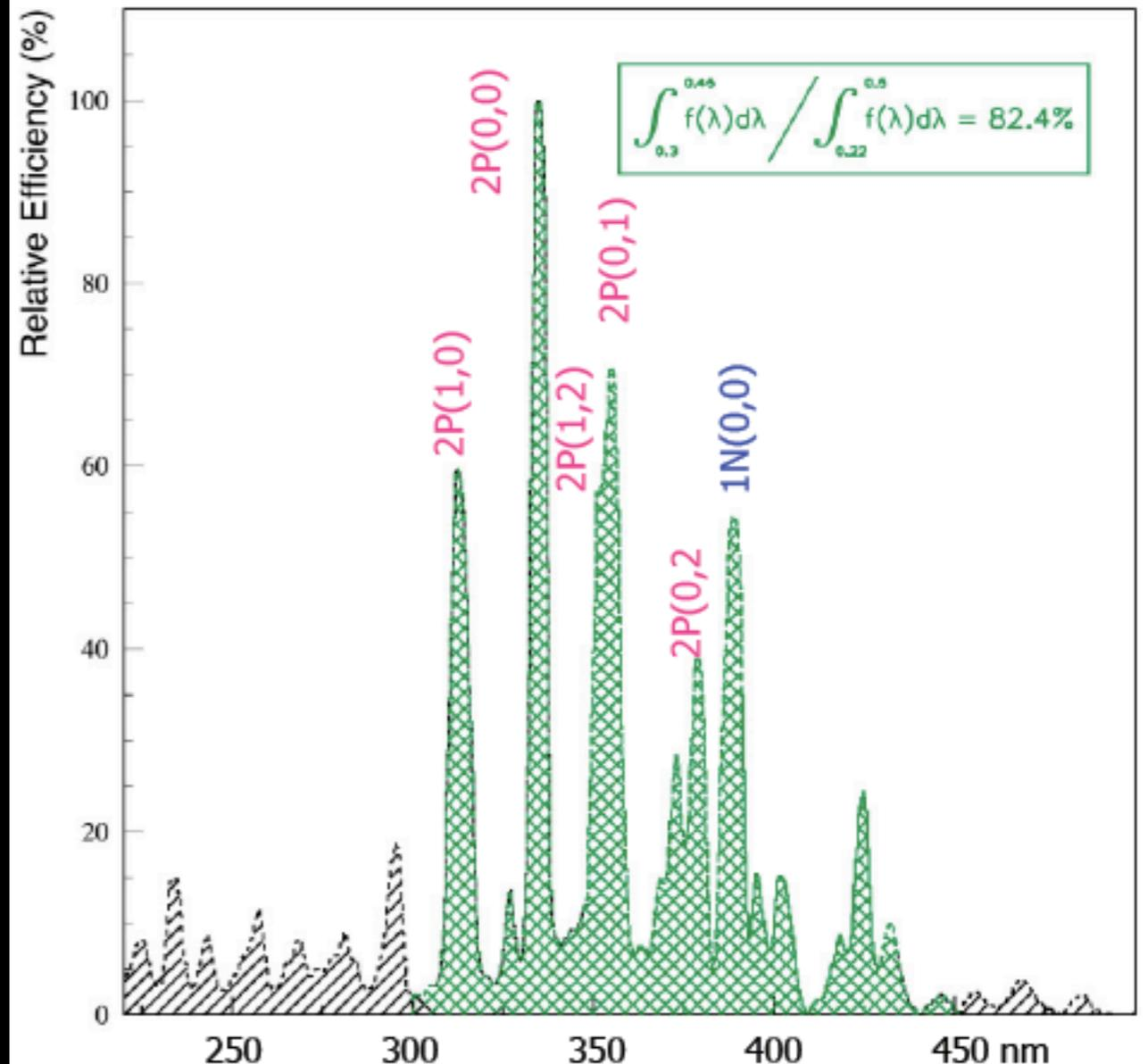

# Radio emission

## *Nani gigantum humeris insidentes (1960s)*

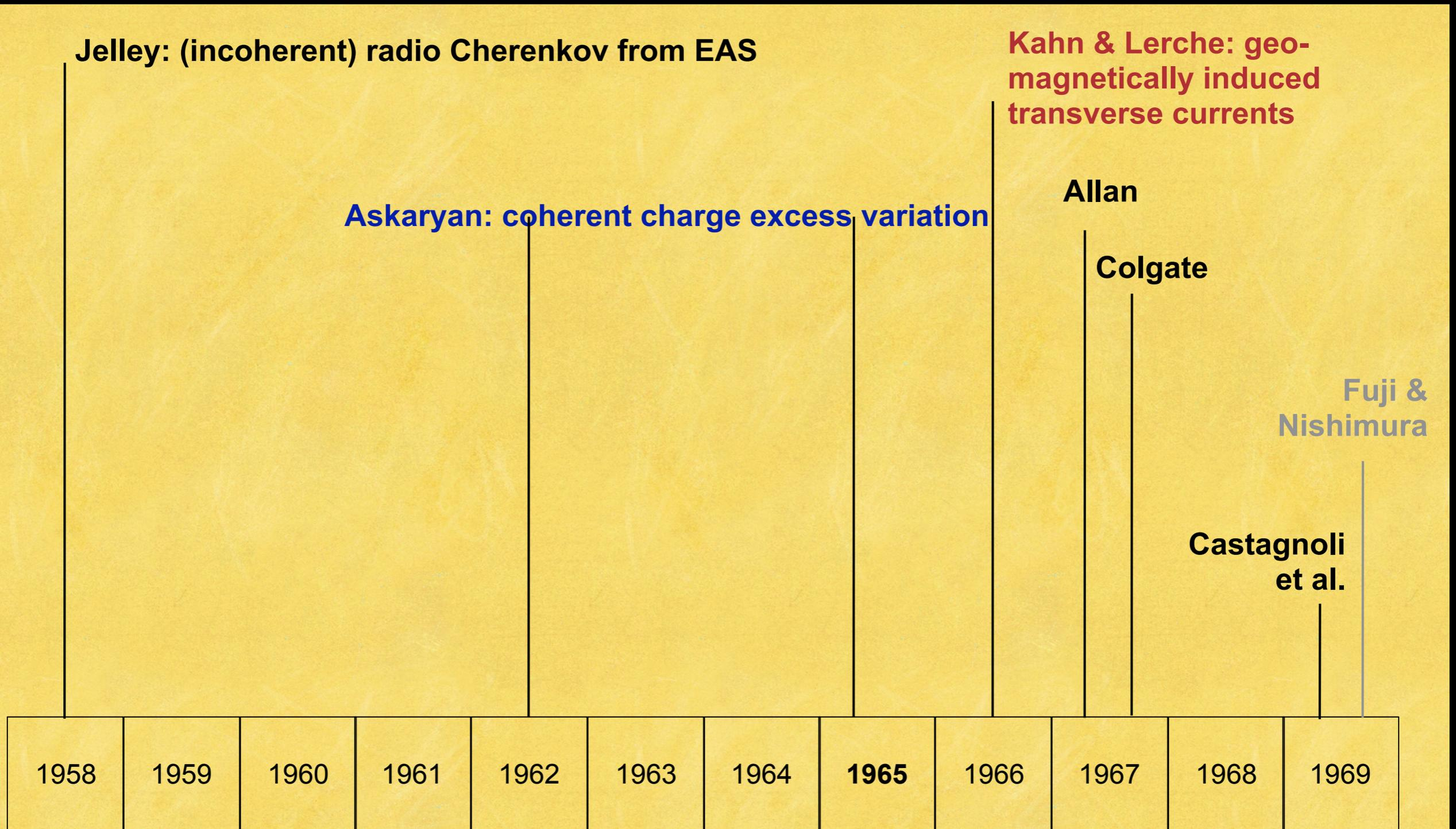

Jelley: (incoherent) radio Cherenkov from EAS

Kahn & Lerche: geomagnetically induced transverse currents

Askaryan: coherent charge excess variation

Allan

Colgate

Fuji & Nishimura

Castagnoli et al.

Jelley et al.: first experimental detection (1965)



# Radio emission

*Nani gigantum humeris insidentes (1960s)*

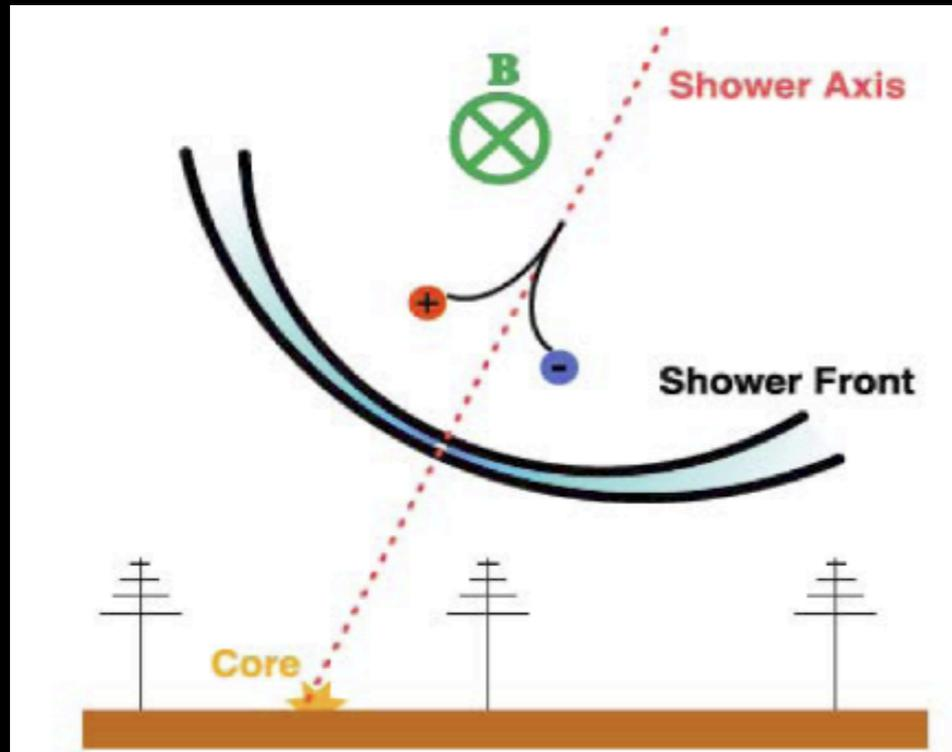

## **Geomagnetic effect:**

deflection of charged particles in Earth's magnetic field (B).  
Electric current develops when the plasma moves through B.  
Radiation emitted by time varying electric current

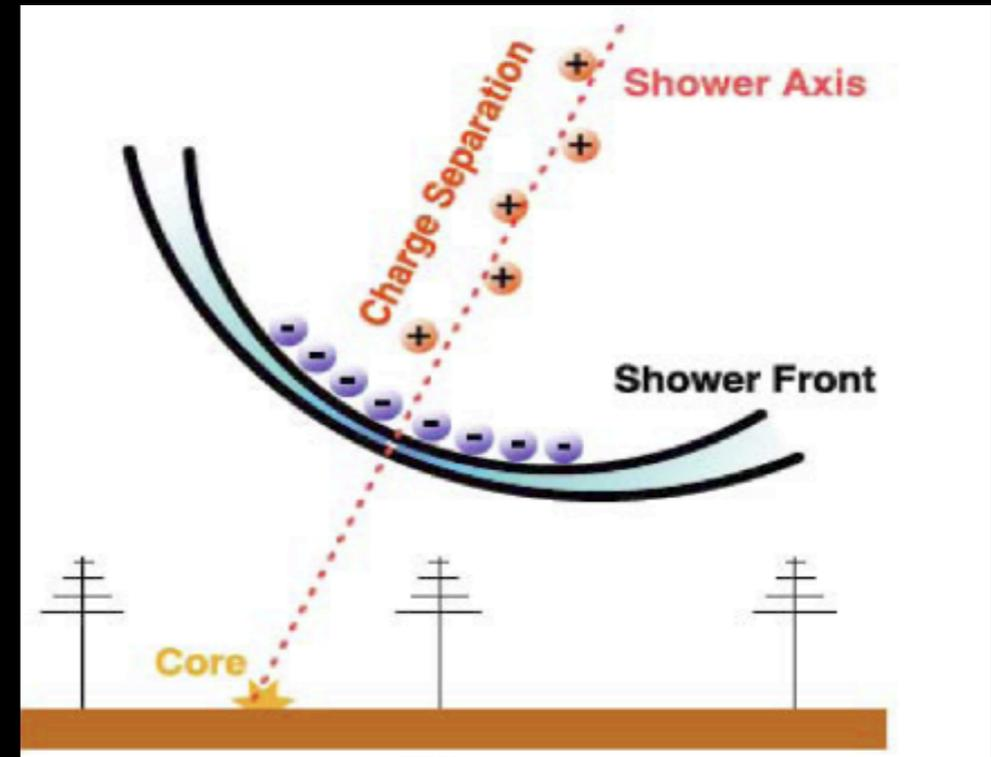

## **Askarian effect:**

radio emission in the form of Cherenkov radiation. Due to the annihilation of positrons an excess of negative charge is created, producing Cherenkov radiation as it moves through the medium (air)

# Different detectors for different observables

**Optical detectors**

**Optical and radio detectors**

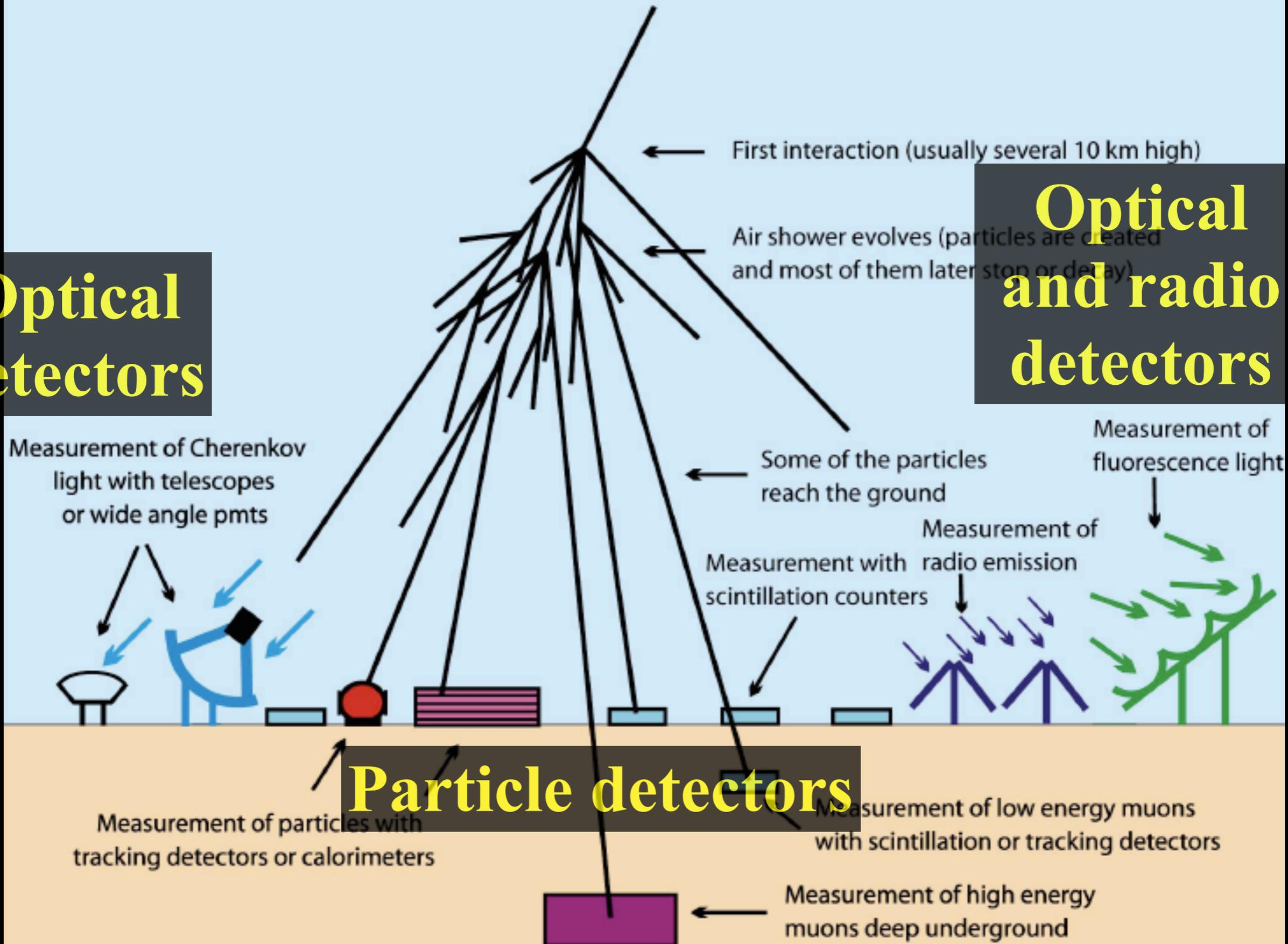

# Different detectors for different observables

## Particle detectors (100% duty cycle)

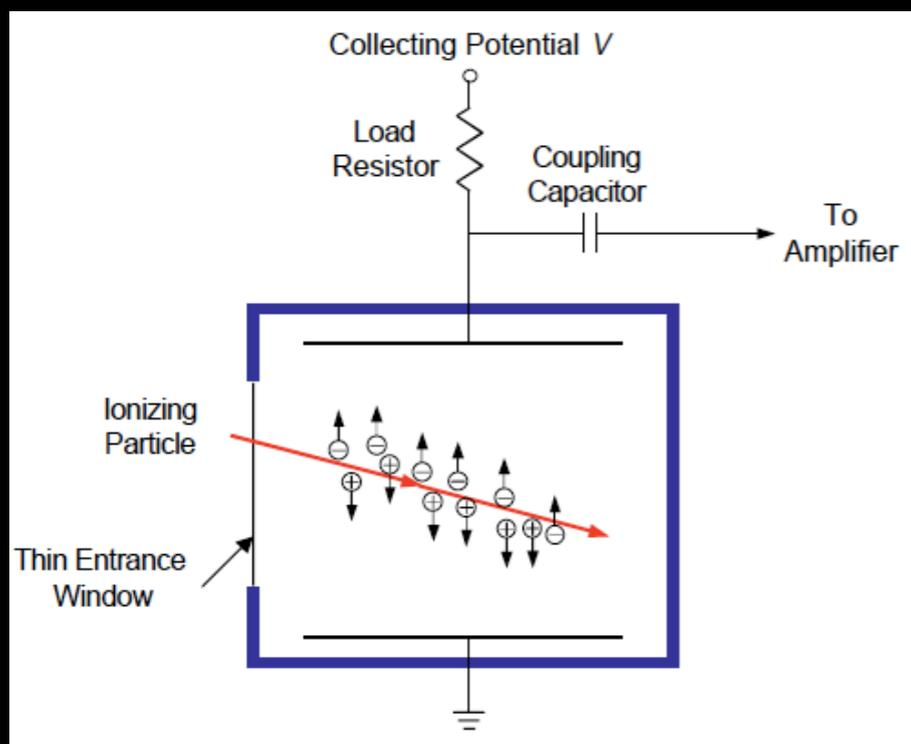

**IONISATION**

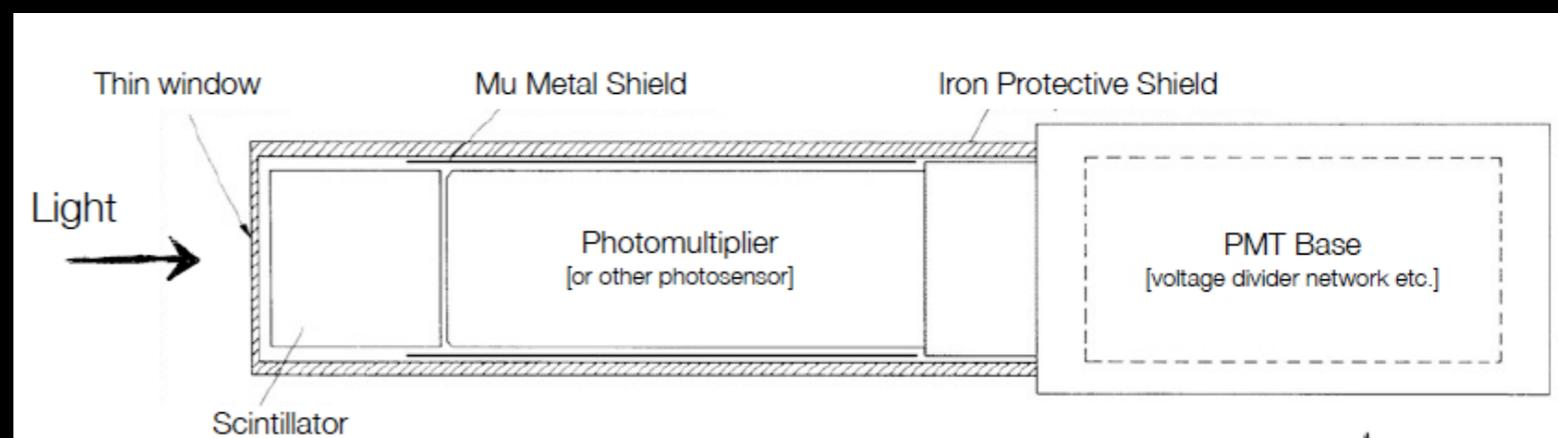

**SCINTILLATORS+PMTs**

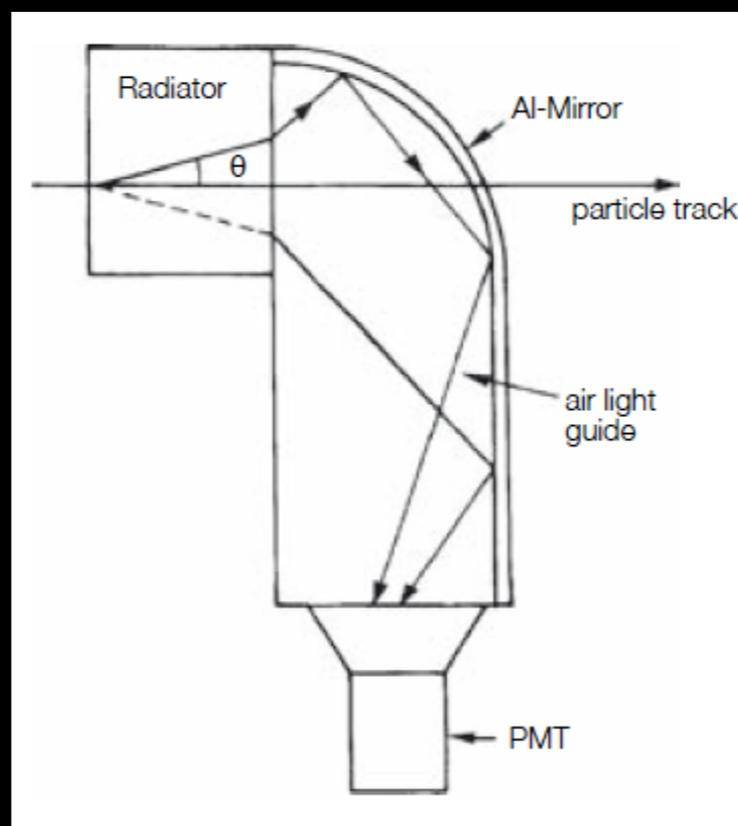

**CHERENKOV**

# Different detectors for different observables

## Particle detectors (100% duty cycle)

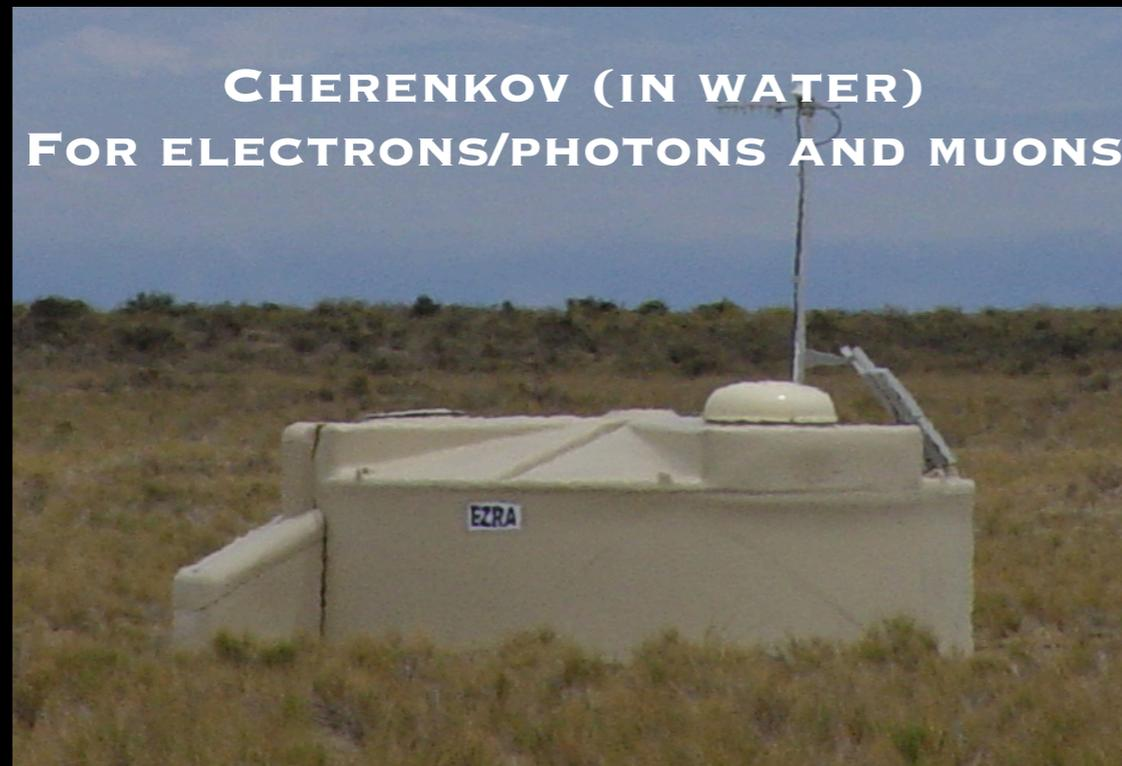

**Pros:  $\approx 100\%$  duty cycle**  
**Cons: observation of the EAS  
at a unique fixed depth**

\*RPC = Resistive Plate Chambers

# Different detectors for different observables

## *Optical detectors (limited duty cycle)*

Cherenkov or fluorescence light is collected by a mirror and imaged onto a camera made by PMTs. Each PMT receives light coming from a specific region of the sky.

When an EAS crosses the field of view of the telescope, it triggers some of the PMTs. Each PMT records the trigger time and the intensity of the signal.

**Pros: observation of the EAS longitudinal development, i.e., at various depths**

**Cons:  $\approx 10\%$  duty cycle**

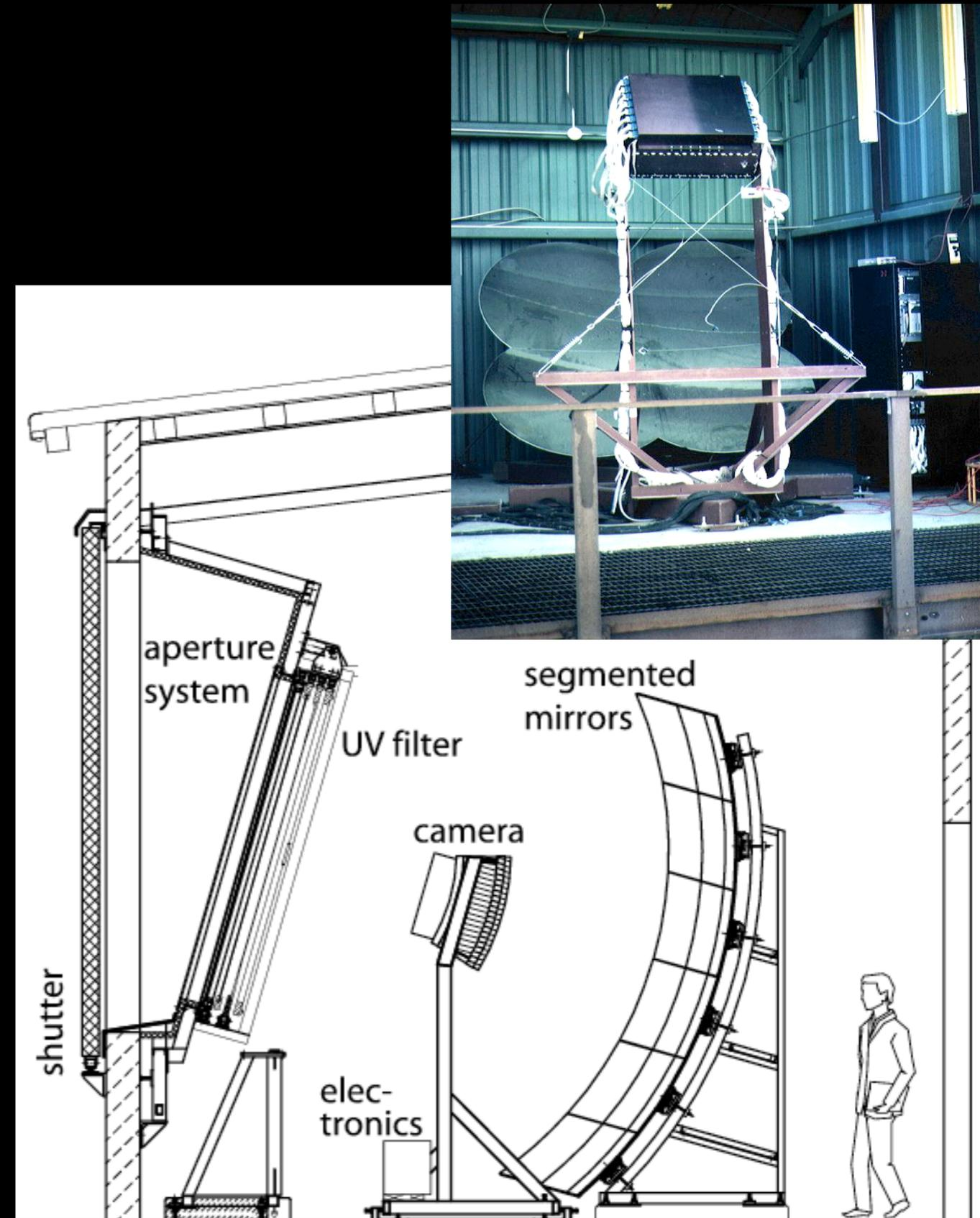

# Different detectors for different observables

## *Radio detectors (100% duty cycle)*

The measurement of the radio signal requires a radio antenna. Typically, one detector station consists of two antennas that are aligned perpendicular to each other, to allow for a measurement of the signal in two polarisation (EW-NS). Antennas can be triggered by traditional EAS arrays, or self-trigger.

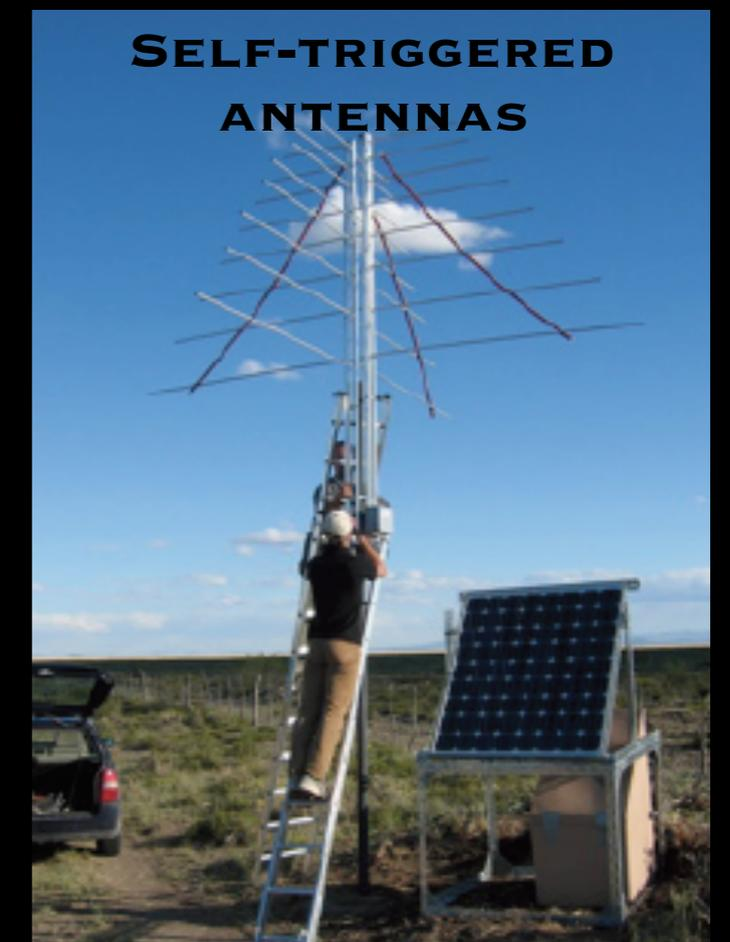
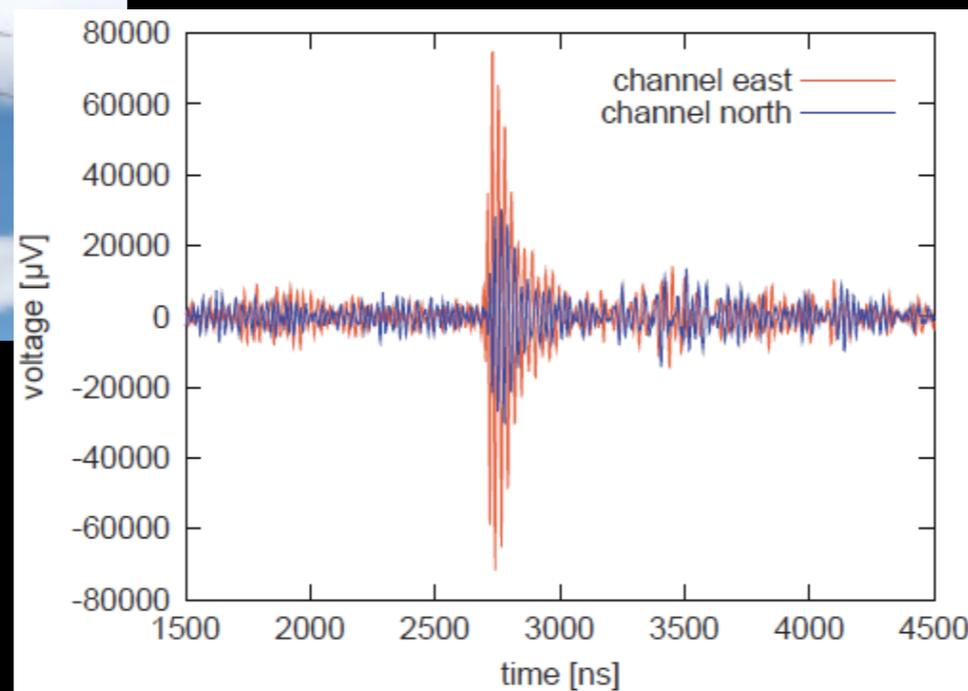
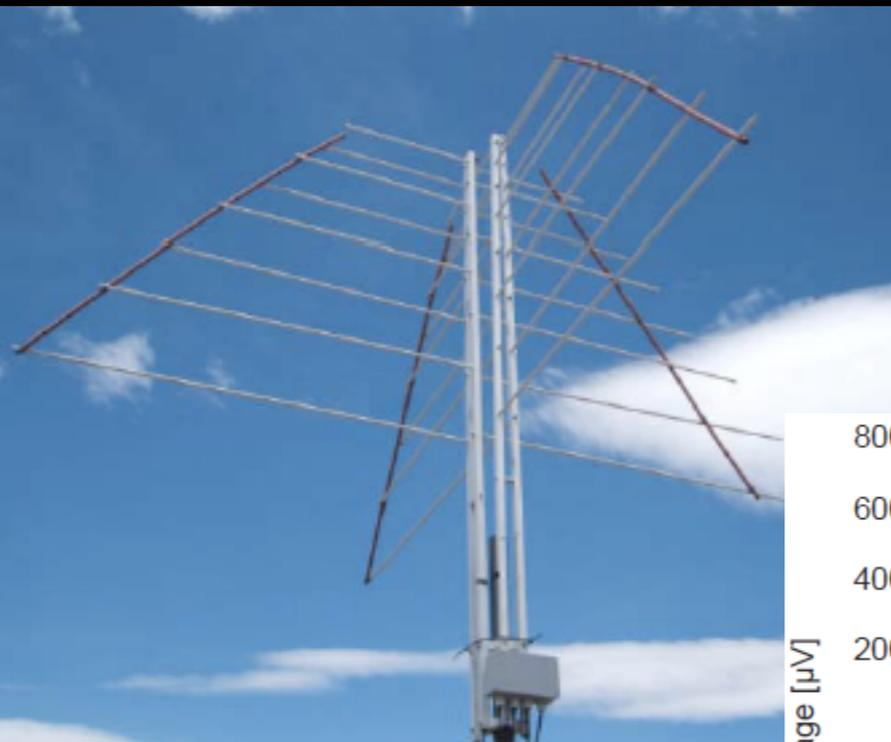
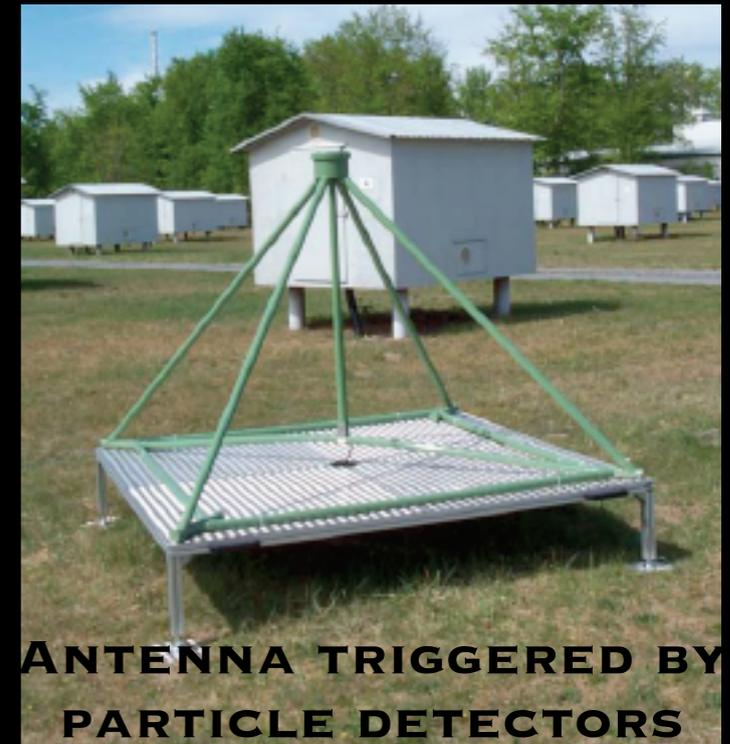

# Detectors are assembled into EAS telescopes/arrays

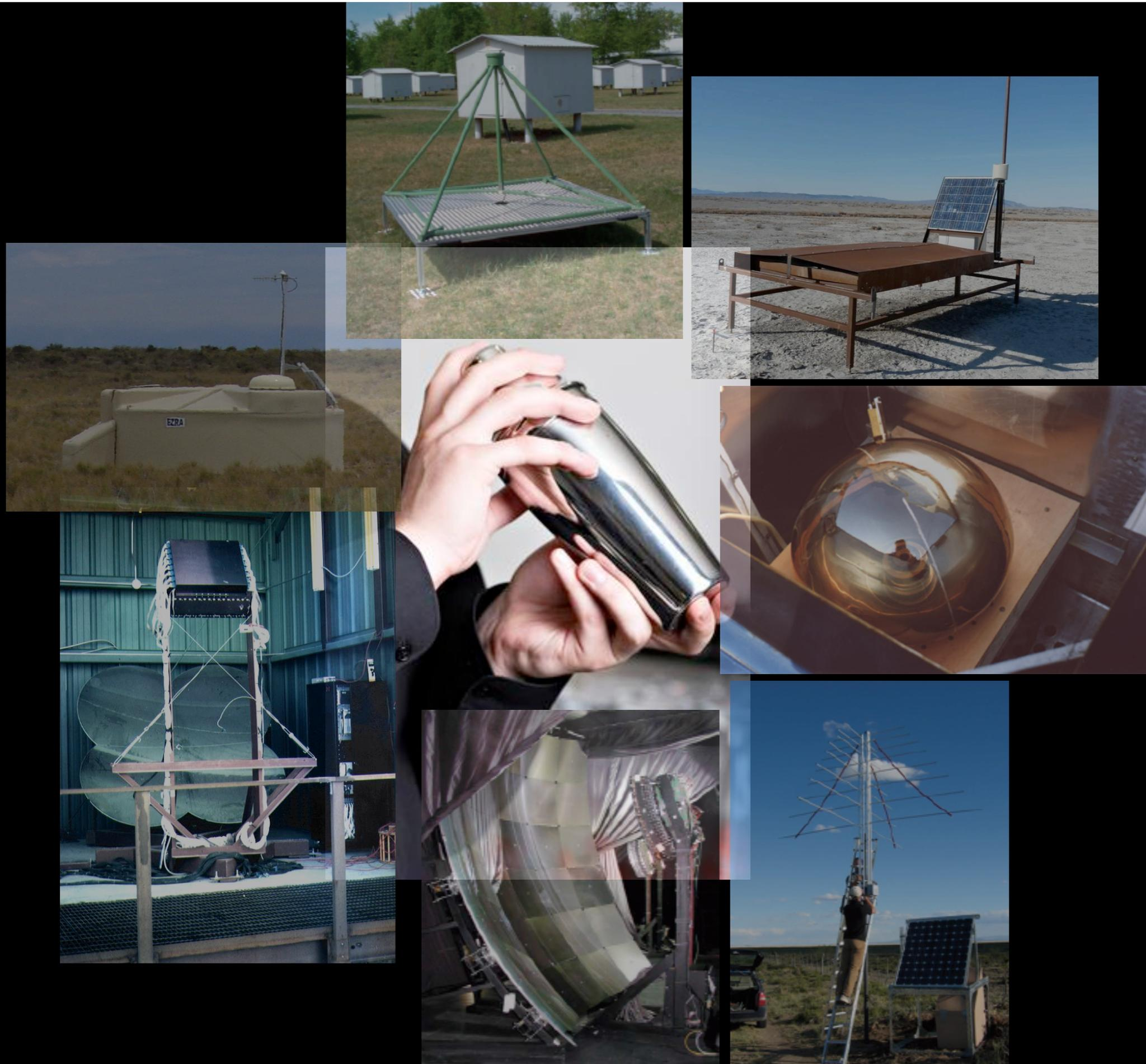

# ...In a way that depends on the energy of interest...

*Choice of detectors spacing and array altitude impacts on energy threshold  
Total area of the array limits the maximum energy*

## **At $10^{11}$ - $10^{13}$ eV (superposition with DIRECT MEASUREMENTS)**

Air showers are re-absorbed high in the atmosphere: very high altitude needed

Air showers are “small”: small spacing needed or full ground coverage (to go down to  $\approx 10^{11}$  eV)

High fluxes: “small” areas sufficient

## **At $10^{14}$ - $10^{16}$ eV**

Shower maximum still high in the atmosphere: moderate mountain altitude needed

Moderate detector spacing needed (<100 m)

Rather low fluxes: moderately large areas needed (0.1 km<sup>2</sup>)

## **At $10^{17}$ - $10^{18}$ eV**

Shower maximum deeper in atmosphere: sea level enough

Low fluxes: areas  $\approx 1$  km<sup>2</sup> needed (detector spacing  $\approx 150$  m)

## **Above $10^{18}$ eV**

Extremely low fluxes: huge area needed ( $\approx 1000$  km<sup>2</sup>)

**N. B. Ideal detector: all (or many) of the shower components  
(multi-component, or hybrid, detector)**



# Recent and current EAS particle experiments

AGASA [Akeno Giant Air Shower Array] (Japan)

**ARGO-YBJ: in Tibet**

BAKSAN (Mt. Caucasus, Russia)

Buckland Park Extensive Air Shower Array (Australia) (operational 1971-1998)

CASA [Chicago Air Shower Array] (operational 1990-1998, USA)

**EAS-TOP (Italy, above the Gran Sasso laboratory, 1990-2000)**

Haverah Park (Leeds University, operational until 1993) (UK)

GRAPES, India

**HAWC, Mexico**

HEGRA (operational 1988-2002) (Spain)

**ICETOP (South Pole, over ICECUBE)**

**KASCADE [KARlsruhe Shower Core and Array DEtector] (Germany)**

**KASCADE-GRANDE (Germany)**

MILAGRO (Water Cherenkov experiment near Los Alamos) (USA)

**Pierre Auger Observatory (Argentina)**

SPASE 2 [South Pole Air Shower Array]

SUGAR [Sydney University Giant Air shower Recorder] (operational from 1968 to 1979)

**Telescope Array (USA)**

Tian-Shan Mountain Cosmic Ray Station

**Tibet AS-gamma experiment: scintillation counter array (Tibet)**

Yakutsk (Russia)

Volcano Ranch (USA)

# Recent and current EAS radiation experiments

AIROBICC (non-imaging counters in the HEGRA array)

BLANCA [Broad Lateral Non-imaging C(h)erenkov Array] (at CASA))

**TUNKA (array of non-imaging counters near Lake Baikal)**

ASHRA [All-sky Survey High Resolution Air-shower detector]

**PIERRE AUGER OBSERVATORY**

EUSO [Extreme Universe Space Observatory ] (proposed)

**HiRes The High Resolution Fly's Eye Cosmic Ray Detector**

**Telescope Array [TA]**

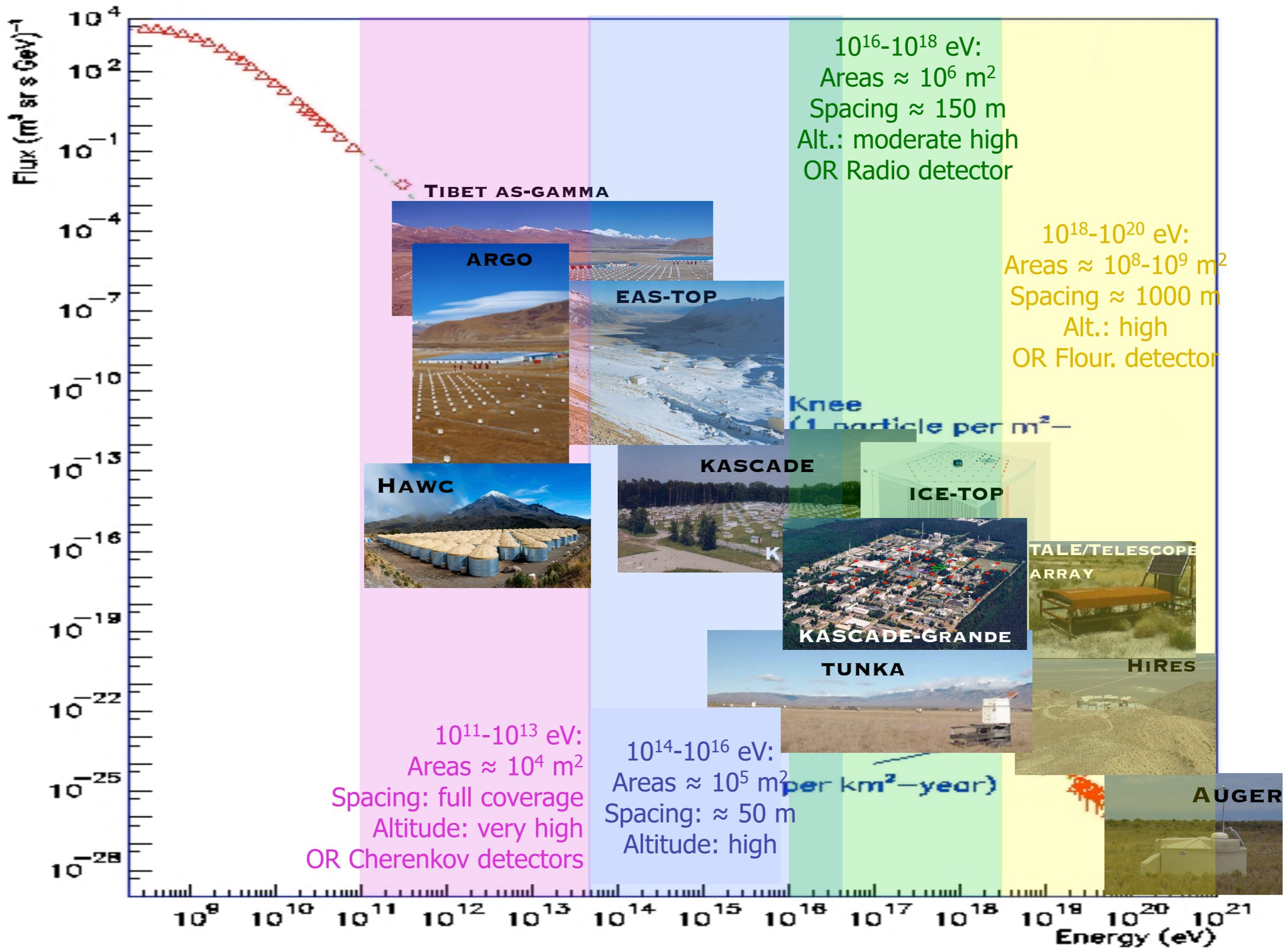

# TO MEASURE COSMIC RAYS AT $10^{11}$ - $10^{13}$ eV: ARGO

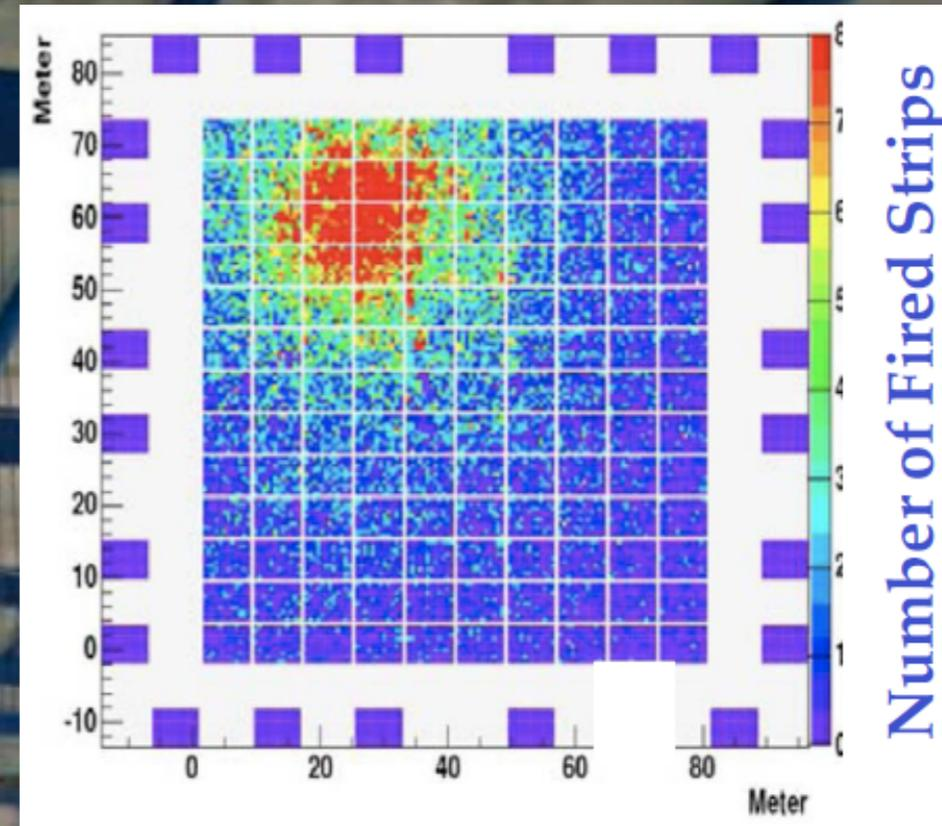
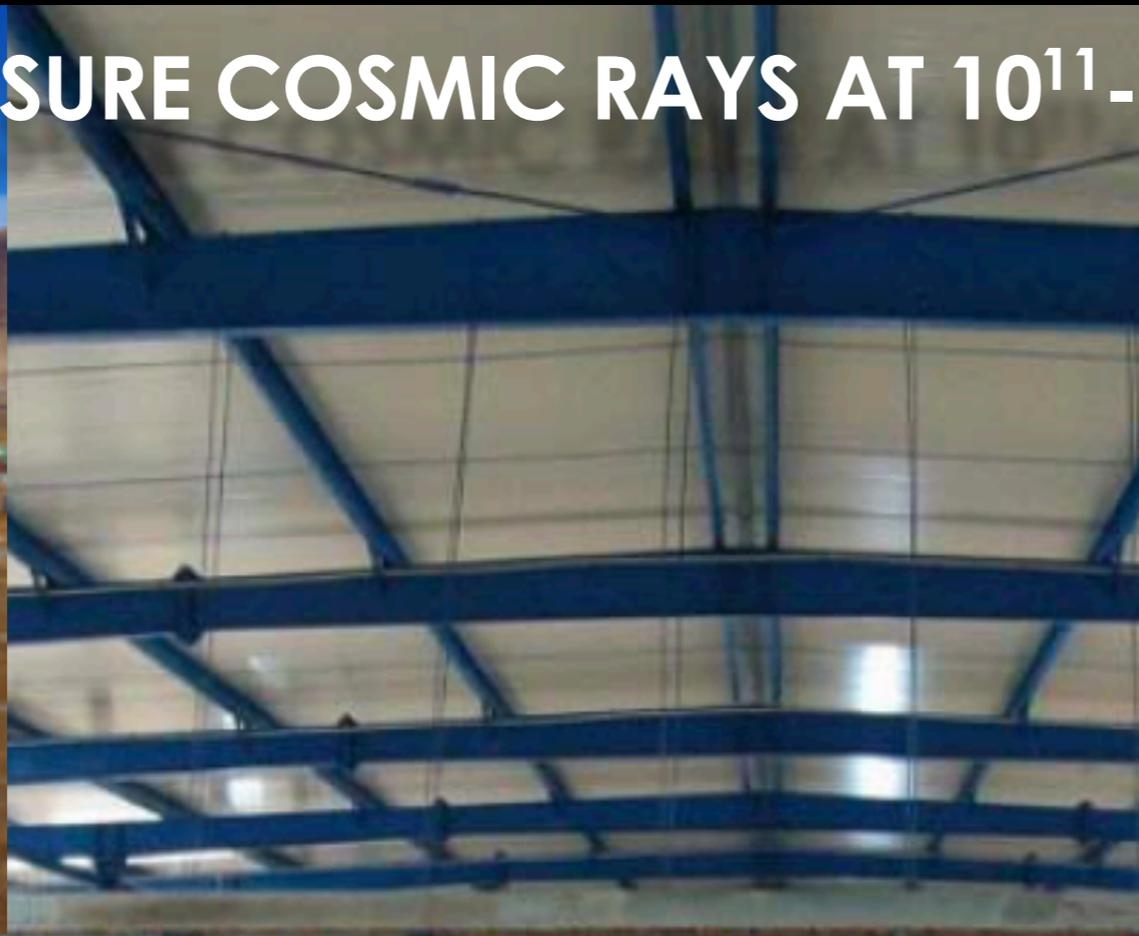

**4300 m a.s.l (Tibet)**  
**“Full coverage” detection surface**  
**RPCs (small space-time “pixels”)**  
**Area  $\approx 10^4$  m<sup>2</sup>**  
**In operation**  
**Energy range:  $10^{11}$ - $10^{13}$  eV**  
**Main physics aims:  $\gamma$ -ray**  
**astronomy, cosmic ray studies**  
**overlapping direct measurements**

**Resistive Plate Chambers carpet**

# TO MEASURE COSMIC RAYS AT $\approx 10^{11}$ - $10^{14}$ eV: HAWC

**4100 m a.s.l (Mexico)**

**300 adjacent water-Cherenkov**

**Area  $\approx 2.2 \times 10^4 \text{ m}^2$**

**In operation**

**Energy range:  $5 \times 10^{11}$ - $10^{14}$  eV**

**Main physics aims:  $\gamma$ -ray astronomy, cosmic ray studies overlapping direct measurements**



# TO MEASURE COSMIC RAYS AT $\approx 10^{13}$ - $10^{15}$ EV: TIBET AS-GAMMA



**4300 m a.s.l (Tibet)**

**697 scintillators @ 7.5 m**

**36 scintillators @ 15 m**

**Area  $\approx 4 \times 10^4 \text{ m}^2$**

**In operation**

**Energy range:  $10^{12}$ - $10^{15}$  eV**

**Main physics aims:  $\gamma$ -ray astronomy,  
cosmic ray studies overlapping direct  
measurements**



# TO MEASURE COSMIC RAYS AT $\approx 10^{14}$ - $10^{16}$ eV: EAS-TOP

2000 m a.s.l (Gran Sasso, Italy)

**MULTI-COMPONENT ARRAY:**

35 scintillator modules 80 m spacing

Central muon/hadron calorimeter

8 Cherenkov telescopes

3 Radio antennas

In operation in the 90s

Area  $10^5$  m<sup>2</sup>

Energy range:  $10^{14}$ - $10^{16}$  eV



**Calorimeter at the center: muon tracking, hadron measurement**

**Main physics aims:  $\gamma$ -ray astronomy, cosmic ray spectrum and composition at the "knee", cosmic ray anisotropies**

# TO MEASURE COSMIC RAYS AT $\approx 10^{14}$ - $10^{16}$ EV: KASCADE

Sea level (Karlsruhe, Germany)

**MULTI-COMPONENT ARRAY:**

**252 scintillator modules (electrons/muons)**

**Central calorimeter**

**In operation in the 90s**

**15 m spacing, area  $4 \times 10^4 \text{ m}^2$**

**Energy range:  $5 \times 10^{14}$ - $5 \times 10^{16}$  eV**

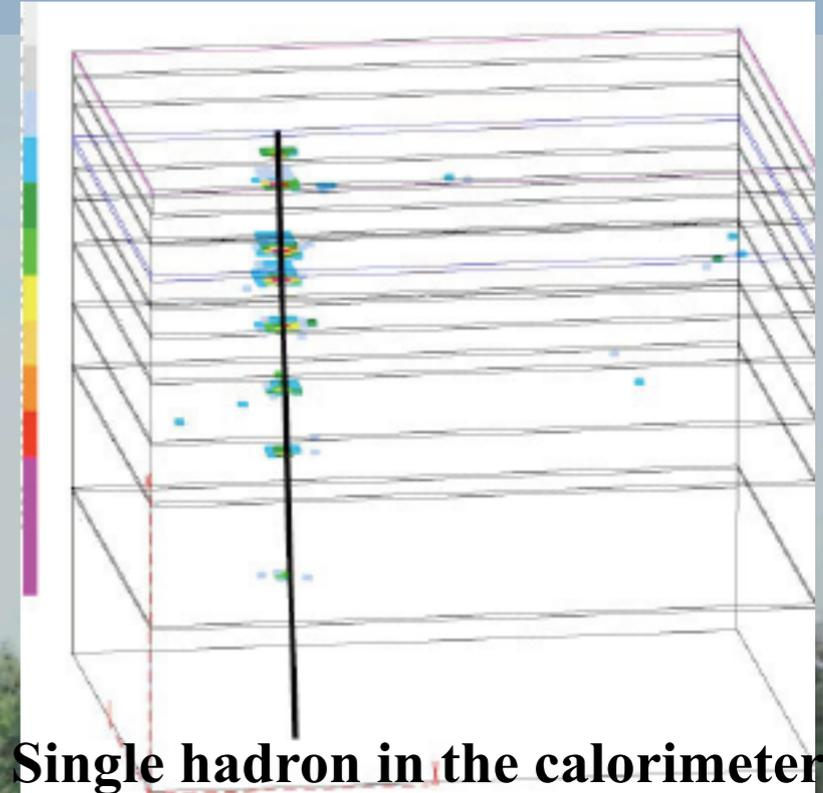

Single hadron in the calorimeter

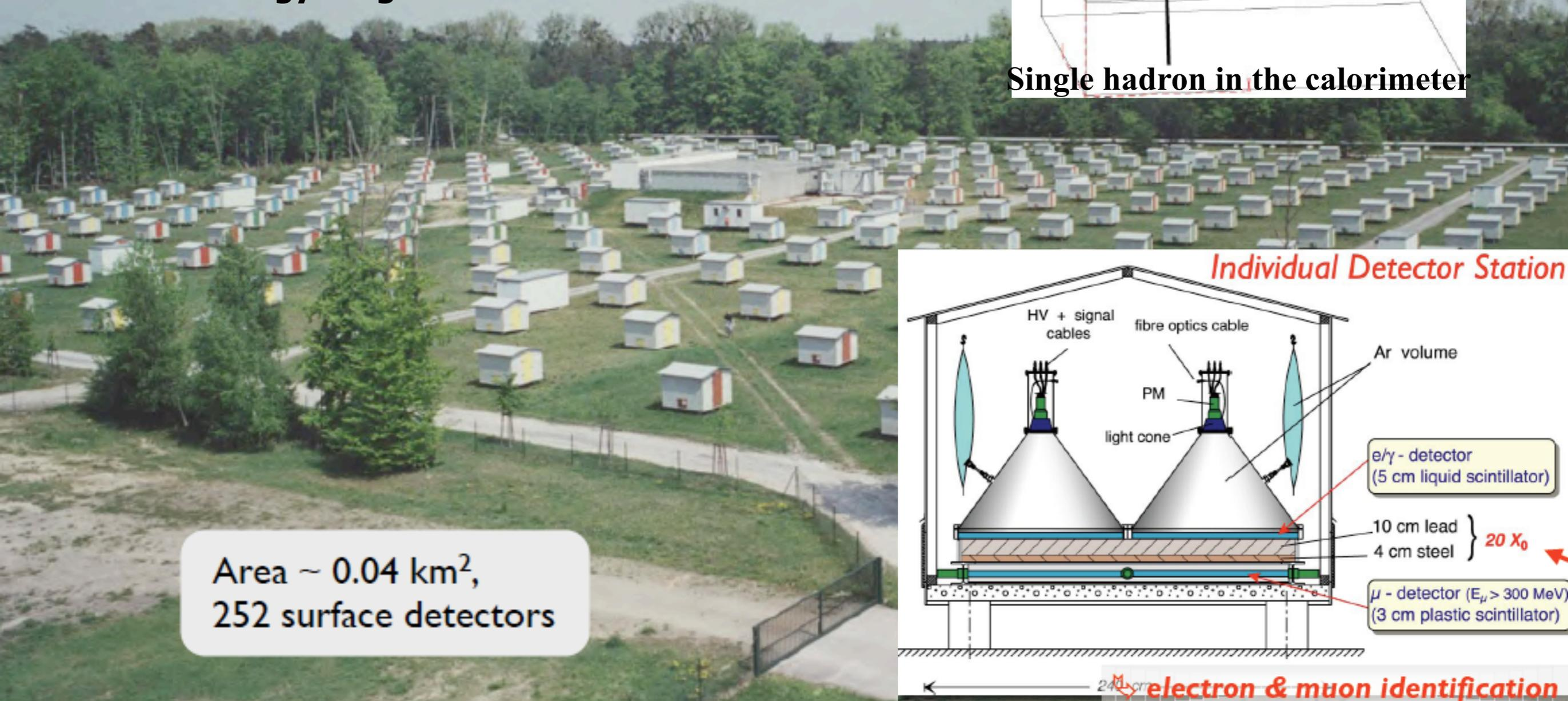

Area  $\sim 0.04 \text{ km}^2$ ,  
252 surface detectors

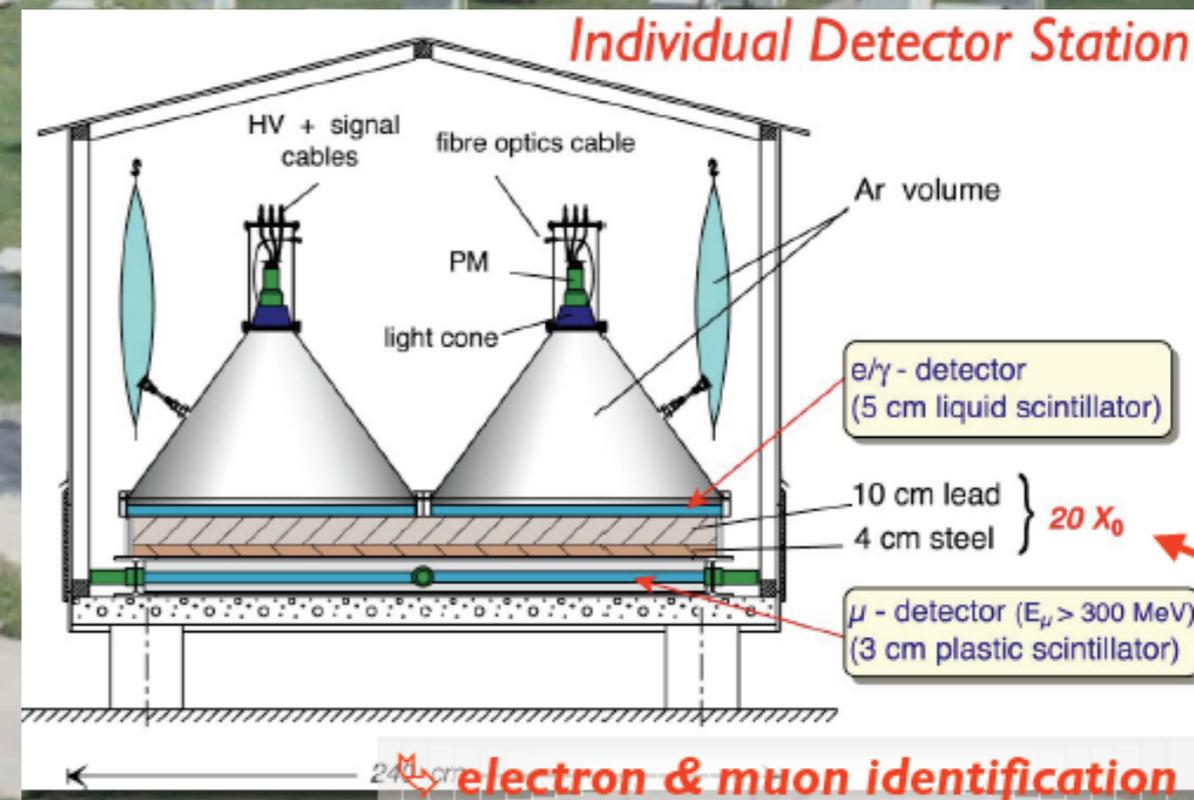



# TO MEASURE COSMIC RAYS AT $\approx 10^{16}$ - $10^{18}$ EV: KASCADE-Grande

Sea level (FZK, Germany)

37 (+252) scintillator modules 130 (15) m spacing

$\approx 1000$  m<sup>2</sup> muon counting

Hadron calorimeter

In operation

Area 0.5 km<sup>2</sup>

Energy range:  $10^{16}$ - $10^{18}$  eV

30 Radio antennas (Lopes array)

**KASCADE**

**Grande**

Main physics aims: cosmic ray spectrum and composition at the '2nd knee', cosmic ray anisotropies

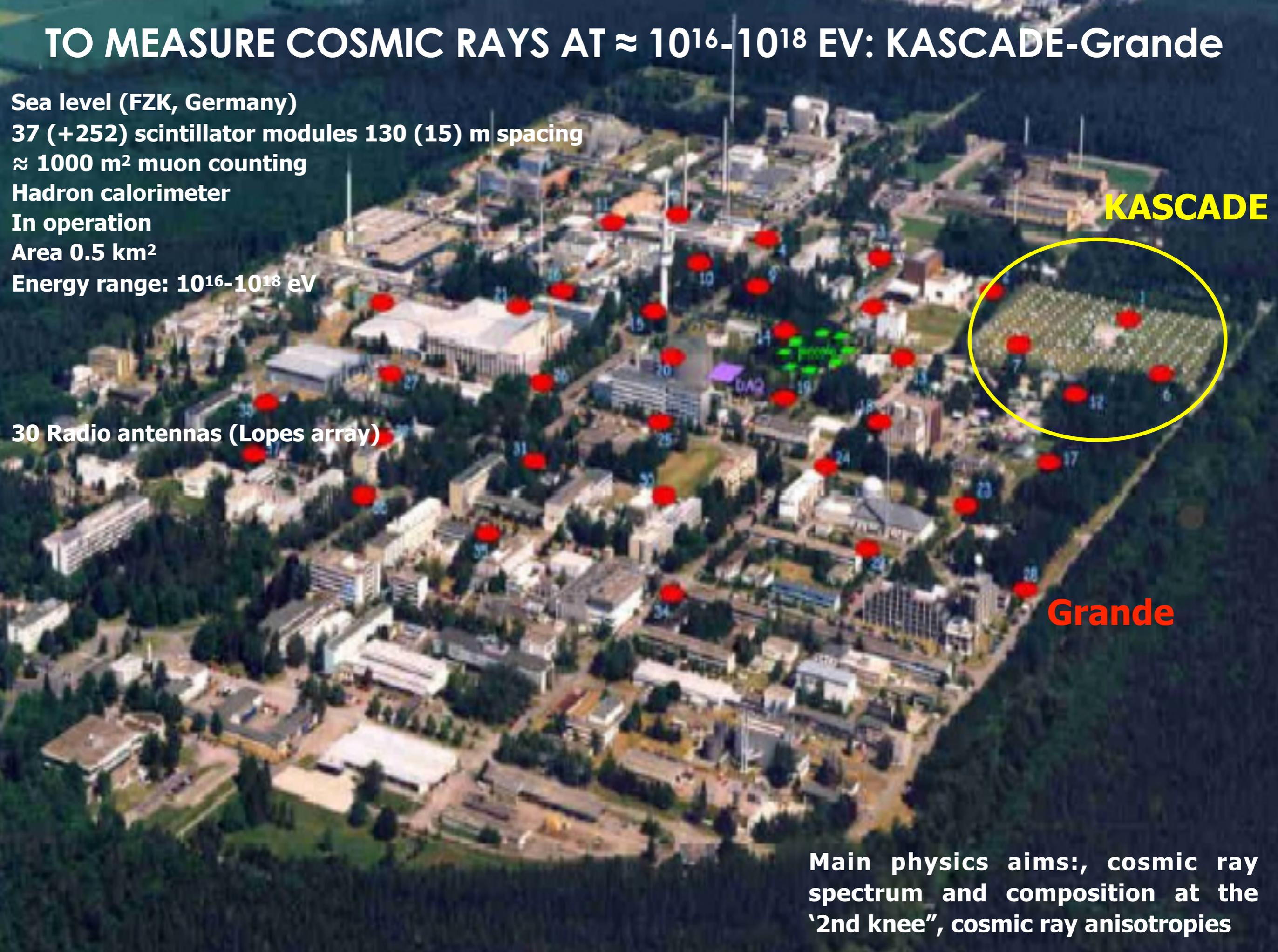

# TO MEASURE COSMIC RAYS AT $\approx 10^{14}$ - $10^{17}$ eV: ICETOP

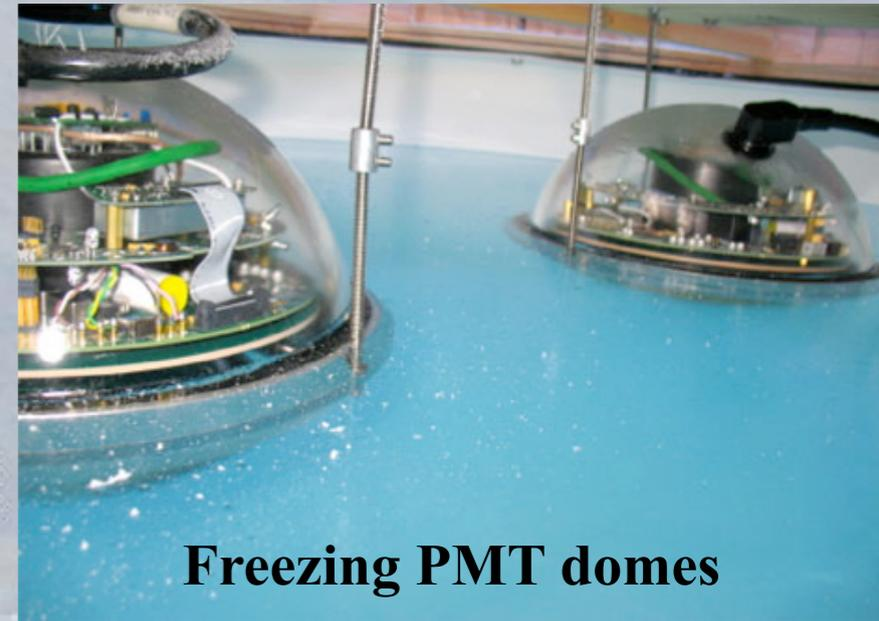
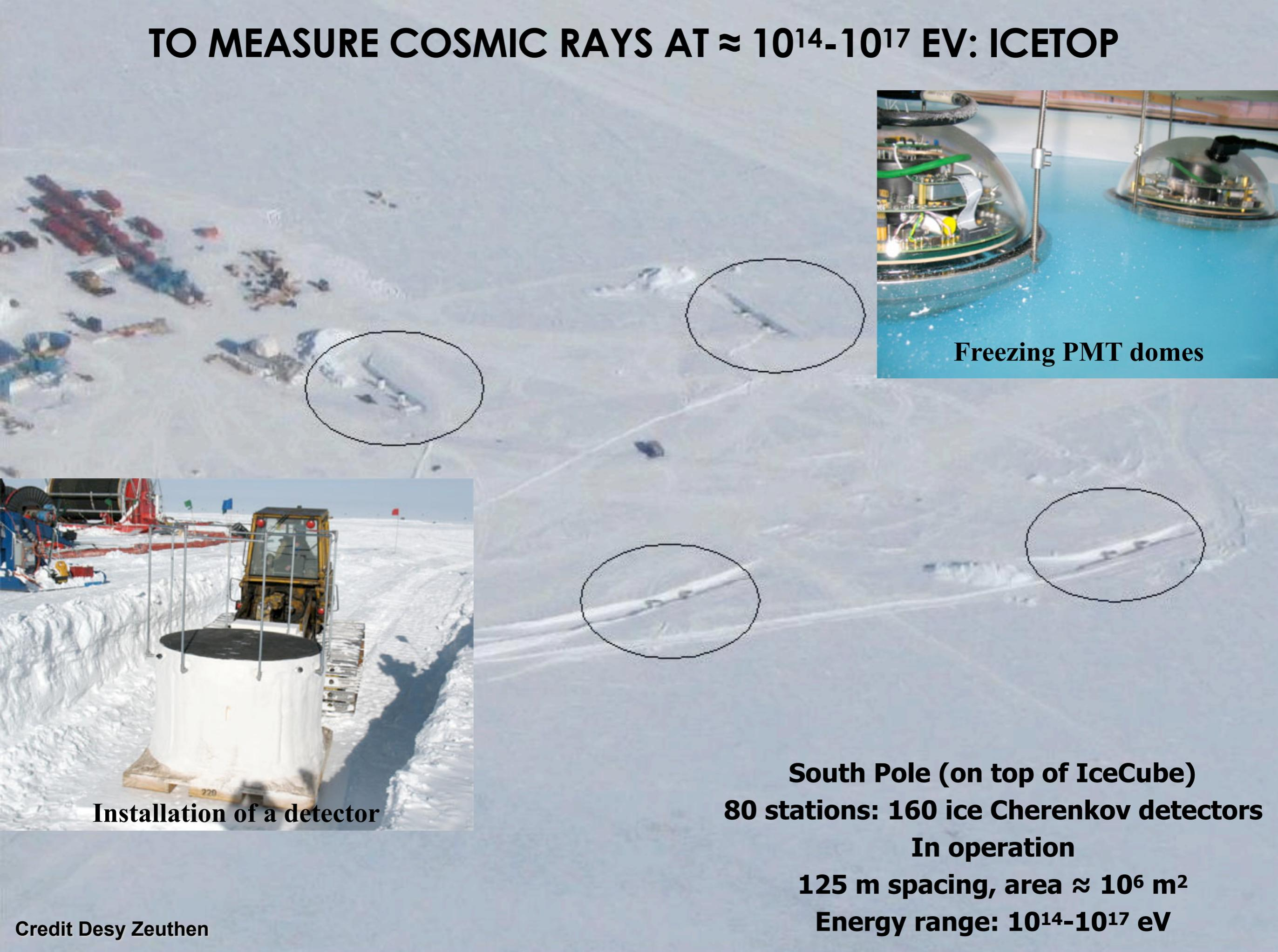

**Freezing PMT domes**



**Installation of a detector**

**South Pole (on top of IceCube)**  
**80 stations: 160 ice Cherenkov detectors**  
**In operation**  
**125 m spacing, area  $\approx 10^6$  m<sup>2</sup>**  
**Energy range:  $10^{14}$ - $10^{17}$  eV**

# TO MEASURE COSMIC RAYS AT $\approx 10^{15}$ - $10^{18}$ EV: TUNKA

Tunka Valley (Russia), 700 m a.s.l.

133 open-air Cherenkov detectors; 19 clusters of 7 detectors each

In operation

Area 1 km<sup>2</sup>; Energy range:  $10^{15}$ - $5 \times 10^{18}$  eV

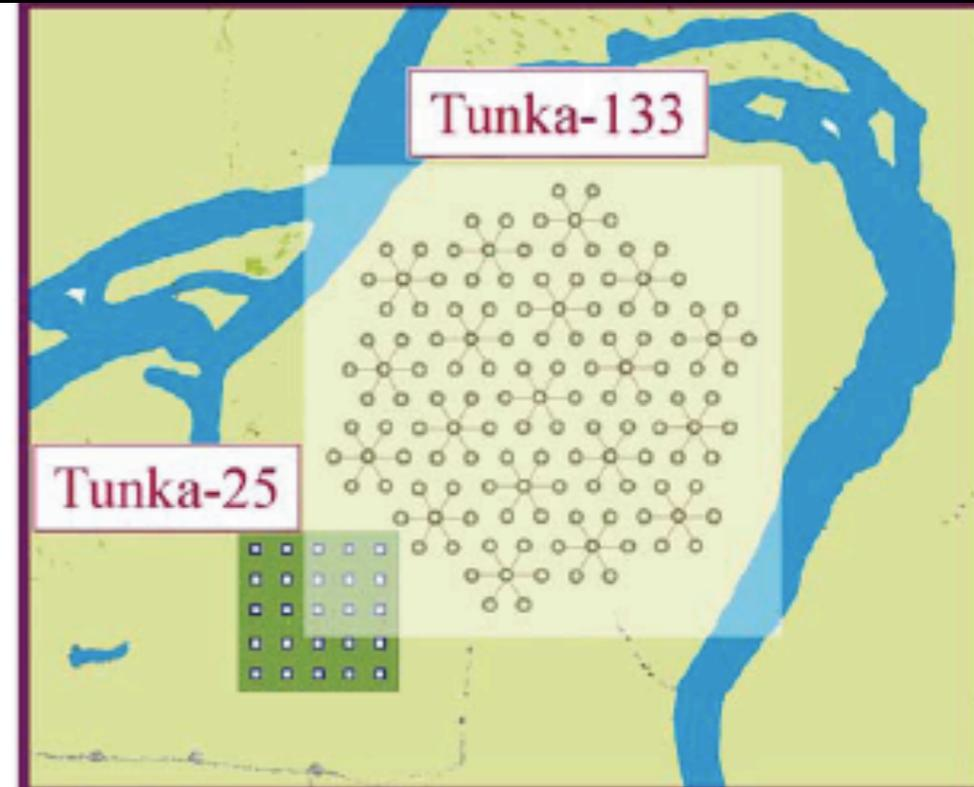

51° 48' 35" N  
103° 04' 02" E  
675 m a.s.l.



# TO MEASURE COSMIC RAYS AT $> 10^{18}$ : FLY'S EYE

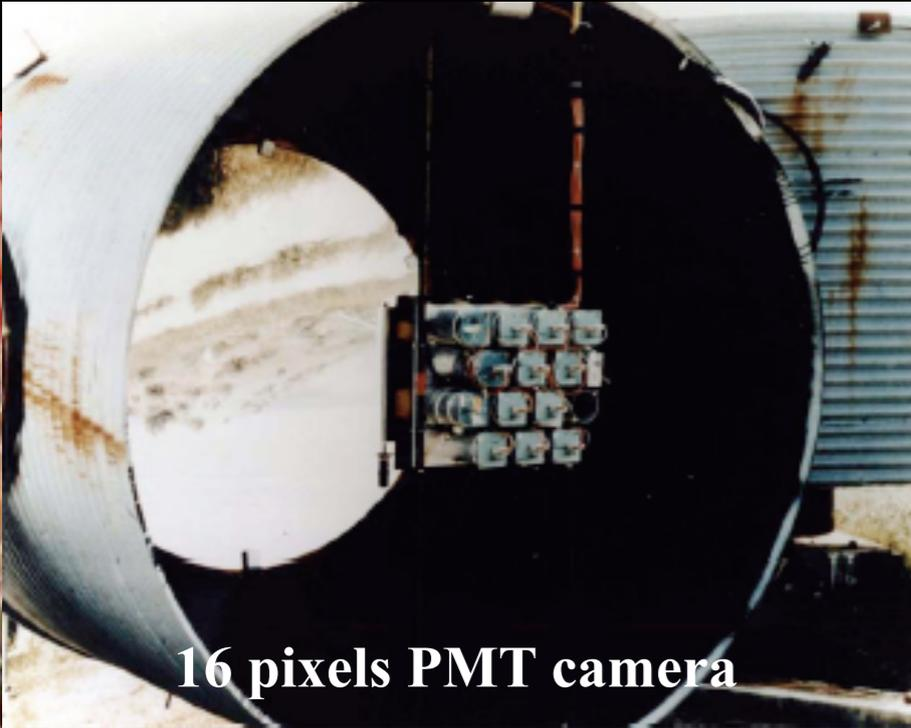

16 pixels PMT camera



Early 80s-1995  
USA, Utah, 100 m a.s.l.  
2 fluorescence telescopes (67 mirrors &  
880 PMTs + 36 mirrors & 464 PMTs)  
Spacing  $\approx 3.4$  km

# TO MEASURE COSMIC RAYS AT $> 10^{18}$ : HiRES



- USA, Utah, 100 m a.s.l. (up to end 2000s)
- 2 fluorescence telescopes (HiRES 1 & 2)
- Larger spacing wrt Fly's Eye  $\approx 12.6$  km
- HiRes 1: 21 mirrors (alt. 3-17 deg): higher statistics, higher energy threshold
- HiRes 2: 42 mirrors (alt. 3-31 deg). Lower energy threshold
- High precision stereo measurements



# To measure cosmic rays at $E > 10^{18}$ eV

*The two giants!*

**2004:**  
**PIERRE AUGER OBSERVATORY**  
**MALARGÜE, ARGENTINA**  
**1660 SURFACE DETECTORS,**  
**4 FLUORESCENCE DETECTORS**

**2008:**  
**TELESCOPE ARRAY,**  
**UTAH, USA**  
**507 SURFACE DETECTORS**  
**3 FLUORESCENCE DETECTORS**

**3000 KM<sup>2</sup>**

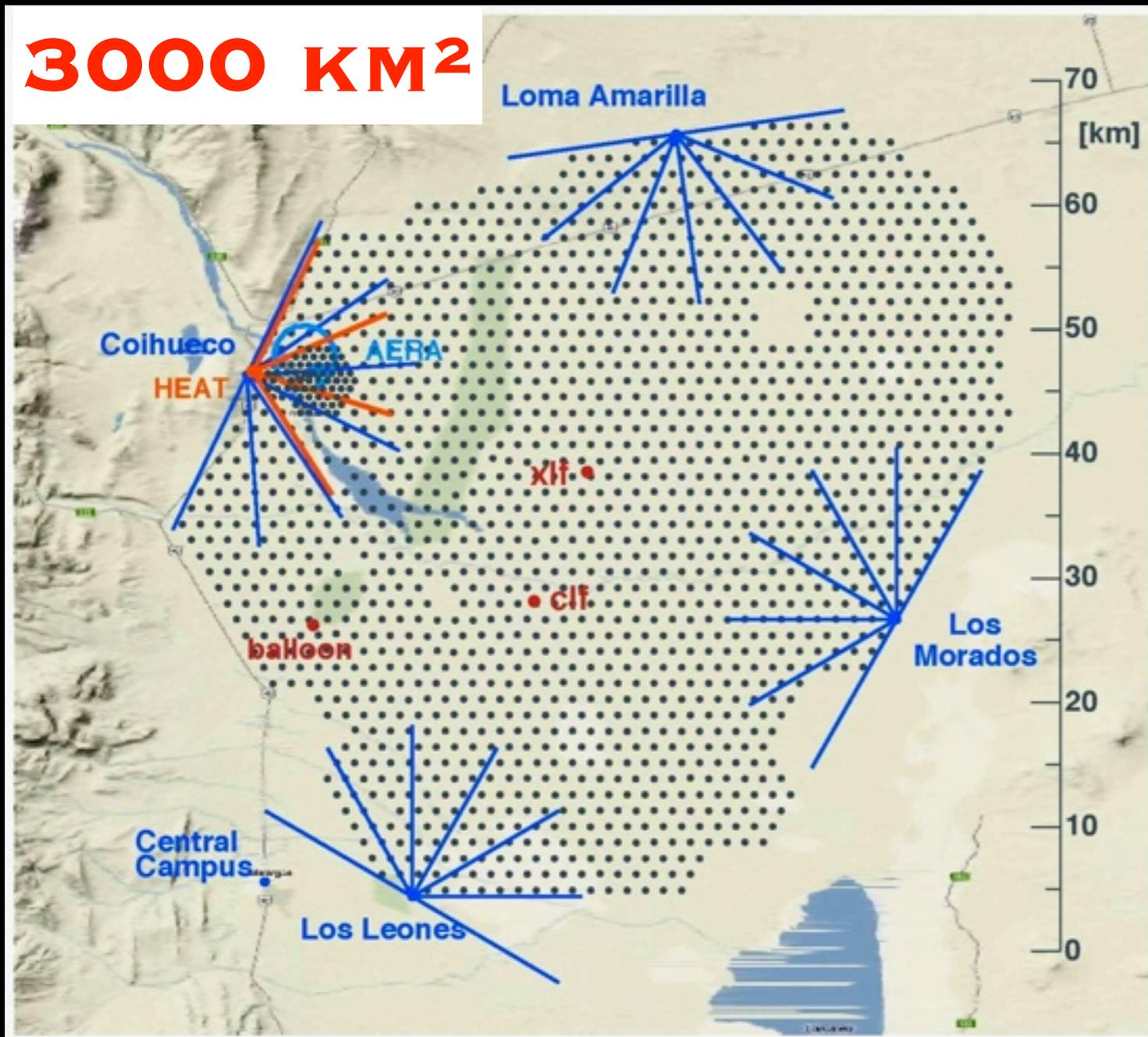

**700 KM<sup>2</sup>**

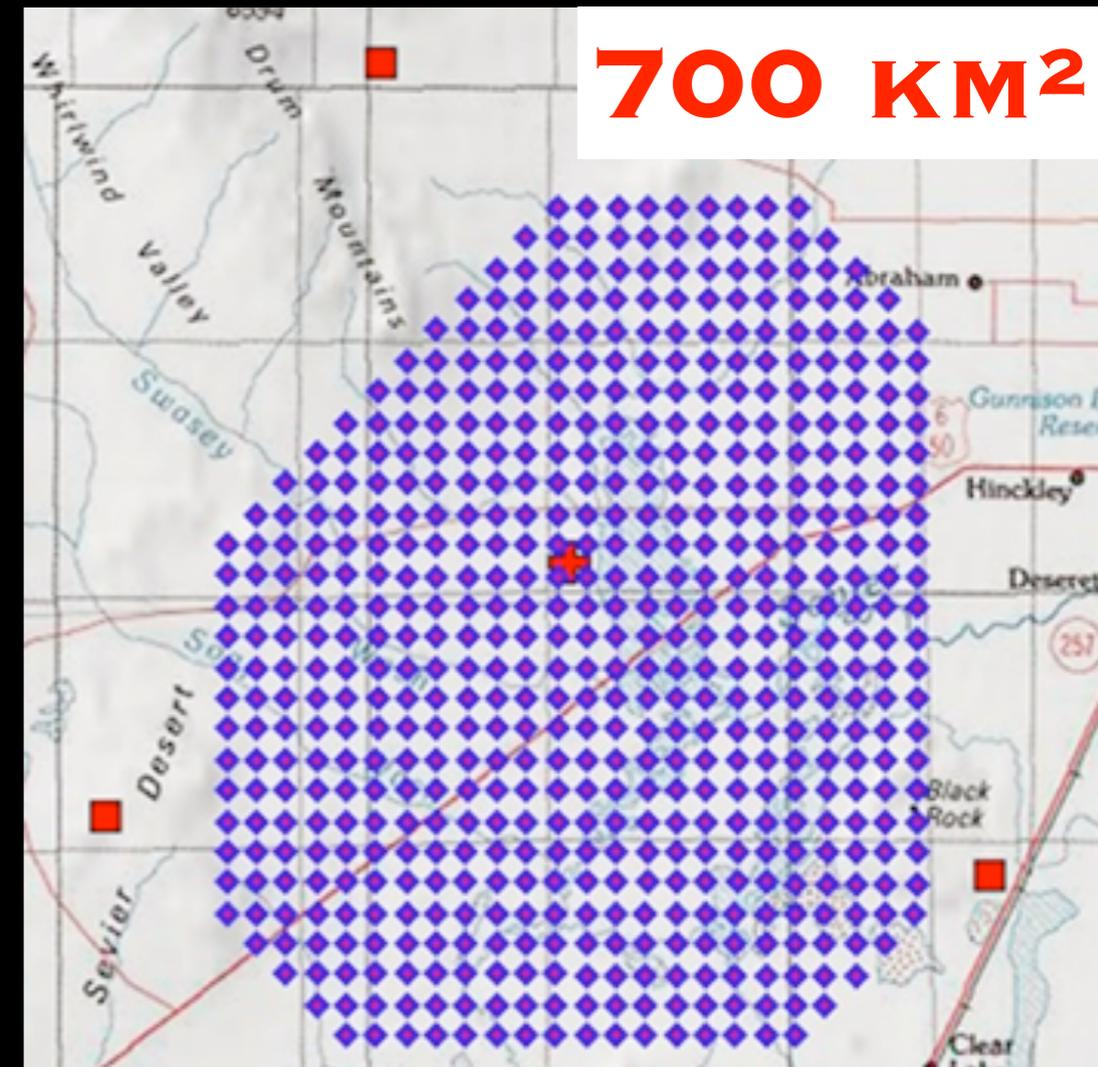

***Two exemplary cases: the Pierre Auger  
Observatory and the Telescope Array:  
EAS observables***

***The delicacy of the observations***

# The Pierre Auger Observatory

**SURFACE ARRAY:  
1600 WATER  
CHERENKOV  
STATIONS, 1500 M  
SPACING,  $A \approx 3000 \text{ km}^2$**



**LIDAR AND LASER  
FACILITIES**



**4 FLUORESCENCE  
DETECTORS:  
24 TELESCOPES IN  
TOTAL**

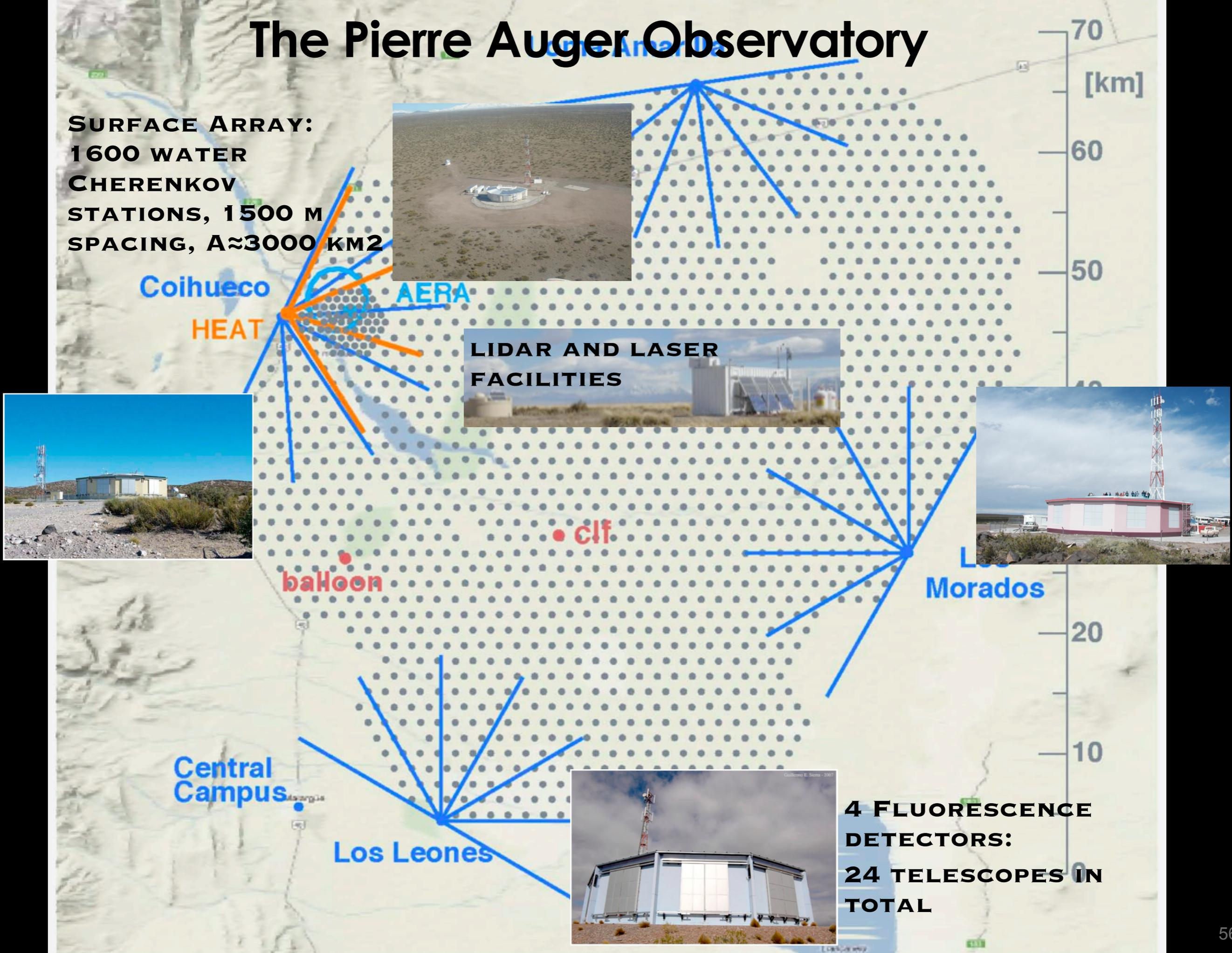



# The Telescope Array

39.3°N, 112.9°W  
~1400 m a.s.l.

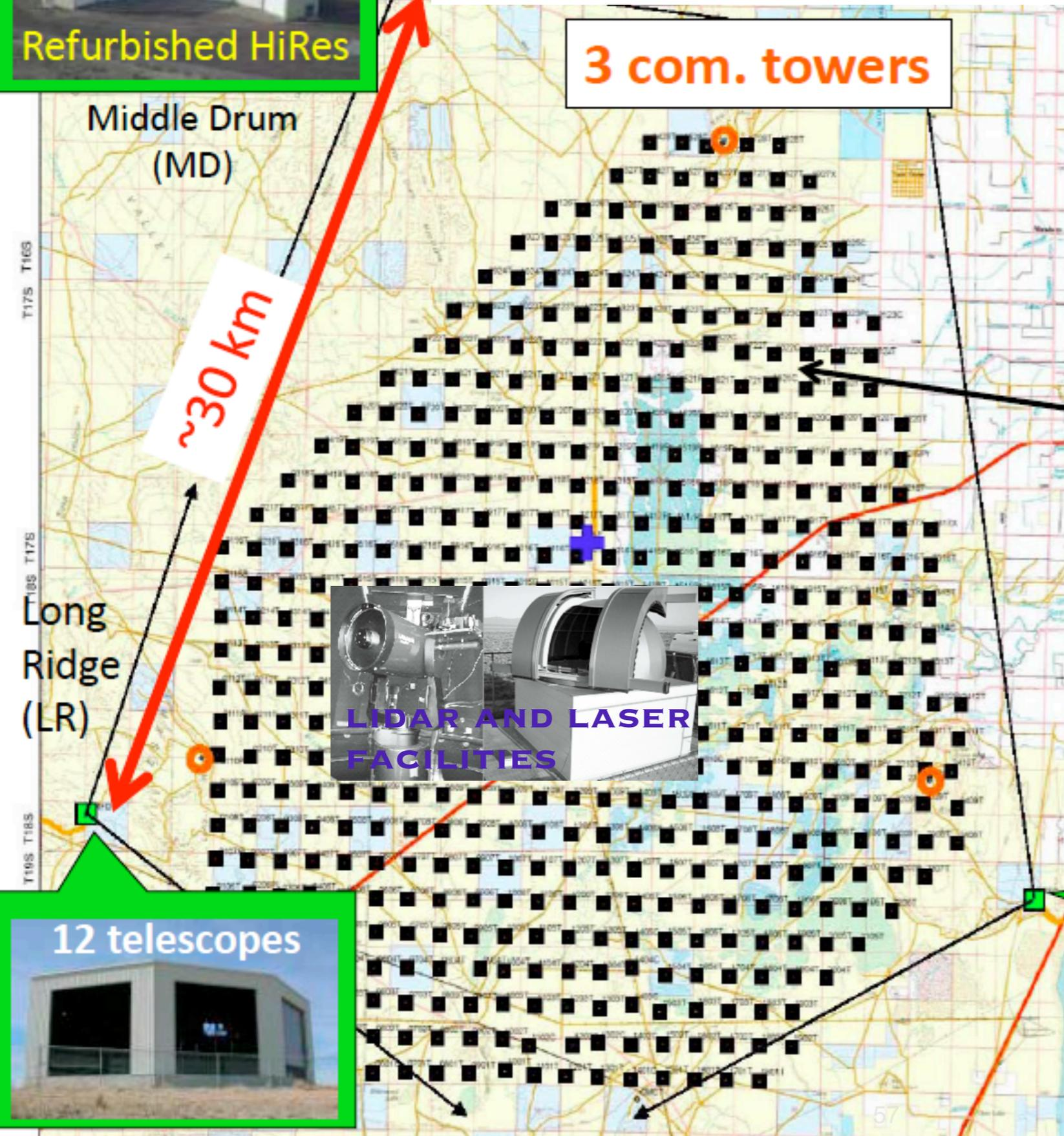

## Surface Detector (SD)

507 plastic scintillator SDs  
1.2 km spacing  
700 km<sup>2</sup>



## Fluorescence Detector (FD)

3 stations  
38 telescopes



# Auger and TA surface detectors

## AUGER

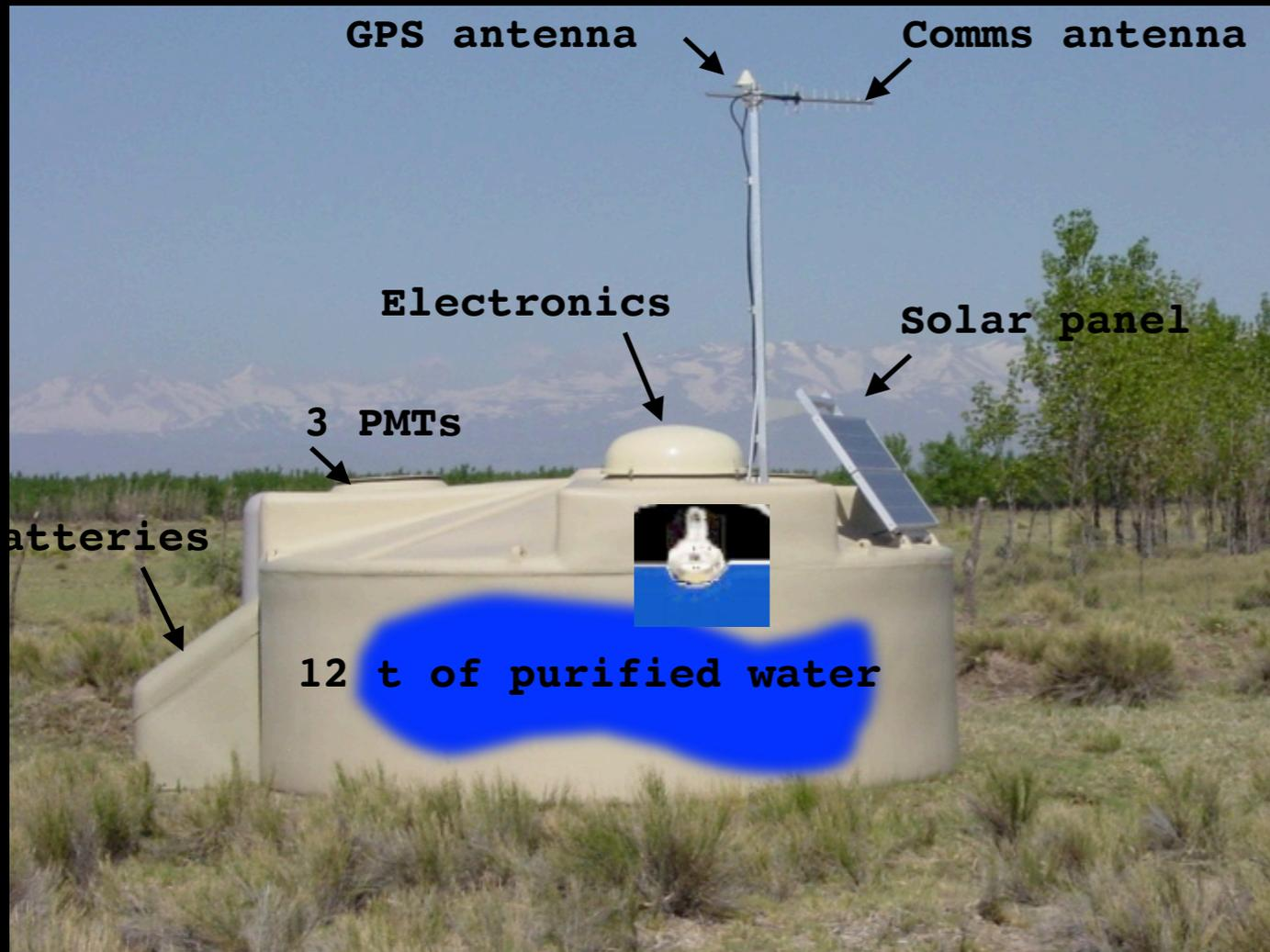

**Water (12 t) Cherenkov detector**  
**3 PMTs/detector**  
**Area: 10 m<sup>2</sup>**  
**Thickness: 1.2 m**  
**Acceptance up to 90 deg**  
**Sensitive to em and mu component**  
**(light signal larger for mu)**

## TELESCOPE ARRAY

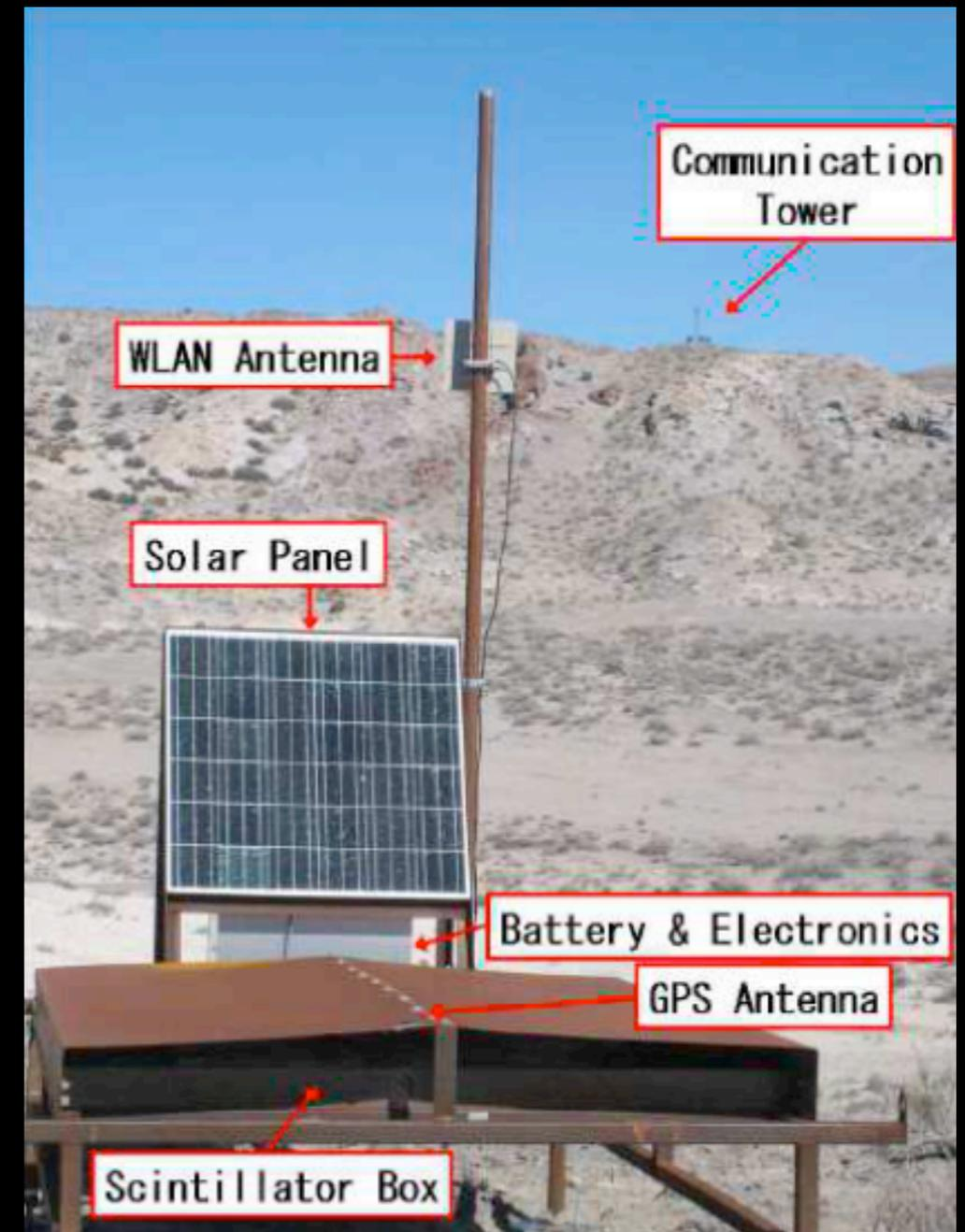

**Scintillators**  
**2 PMTs/detector**  
**Area: 3 m<sup>2</sup>**  
**Thickness: 1.2 cm**  
**Acceptance up to 55 deg**  
**More sensitive to em component**

# Auger and TA surface detectors

## AUGER



Perfectly aligned in the pampa, at a distance of 1.5 km one from another

## TELESCOPE ARRAY

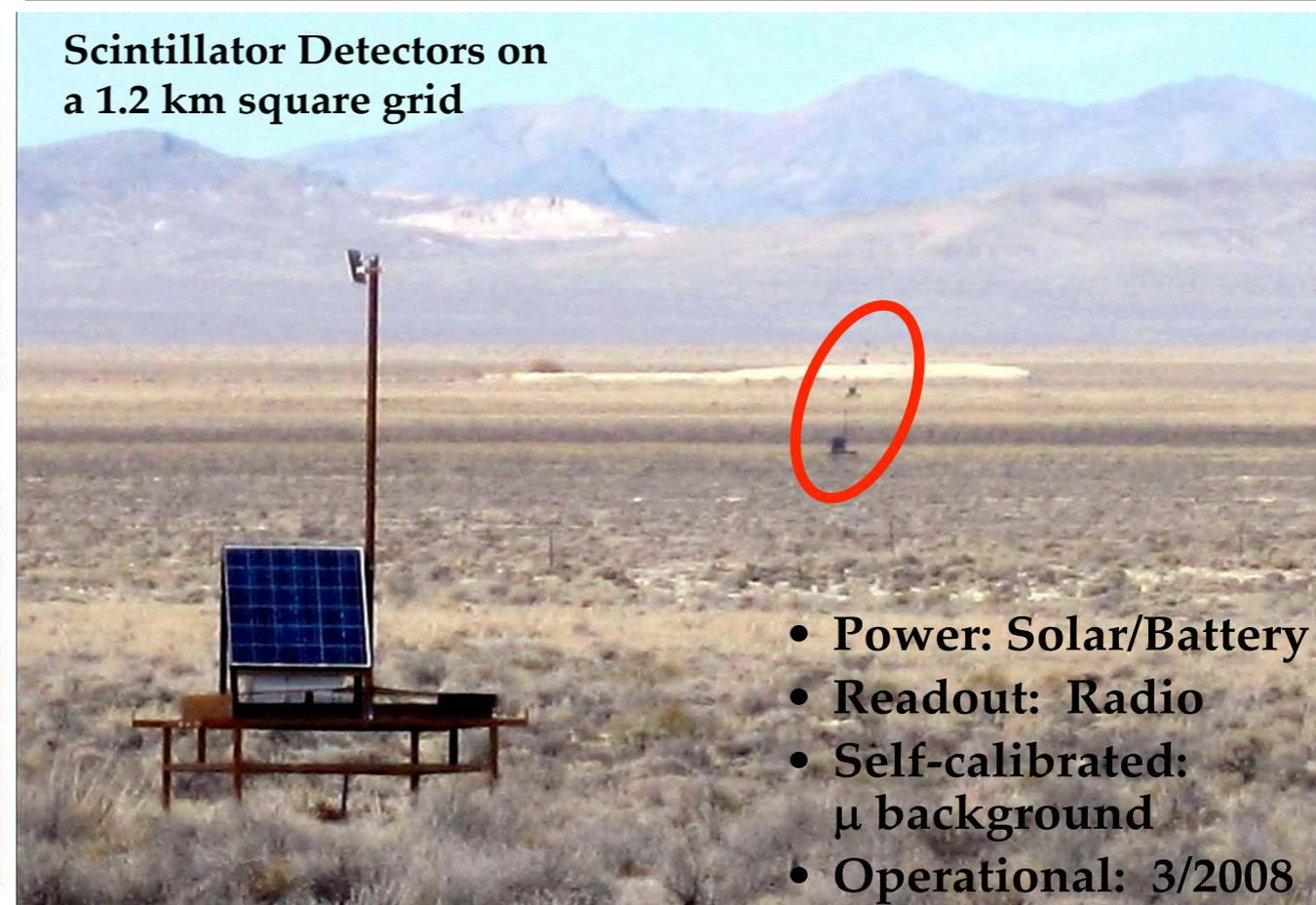

Perfectly aligned in the desert, at a distance of 1.2 km one from another

***Pampa, desert:***

***The adventurous excursion of the observers :-)***

# EAS signals in surface detectors

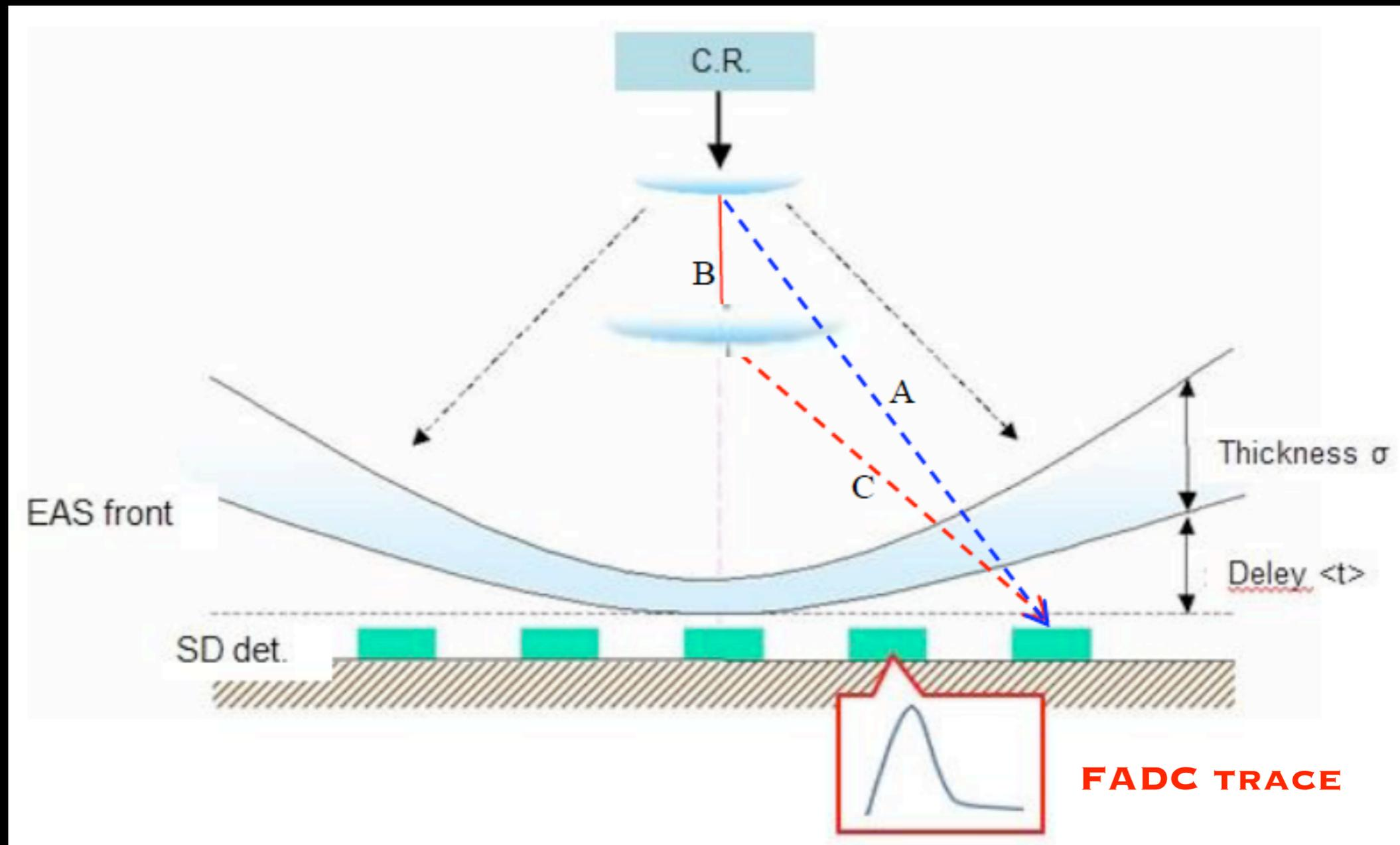

The PMTs signals are digitized by Fast Analog-to-Digital Converters (FADC), with a sampling time of 25 (20) ns.

When the signals are above a certain threshold in at least 3 detectors within a certain time, the DAQ starts

# EAS signals in surface detectors

*Examples of real FADC traces*

## AUGER

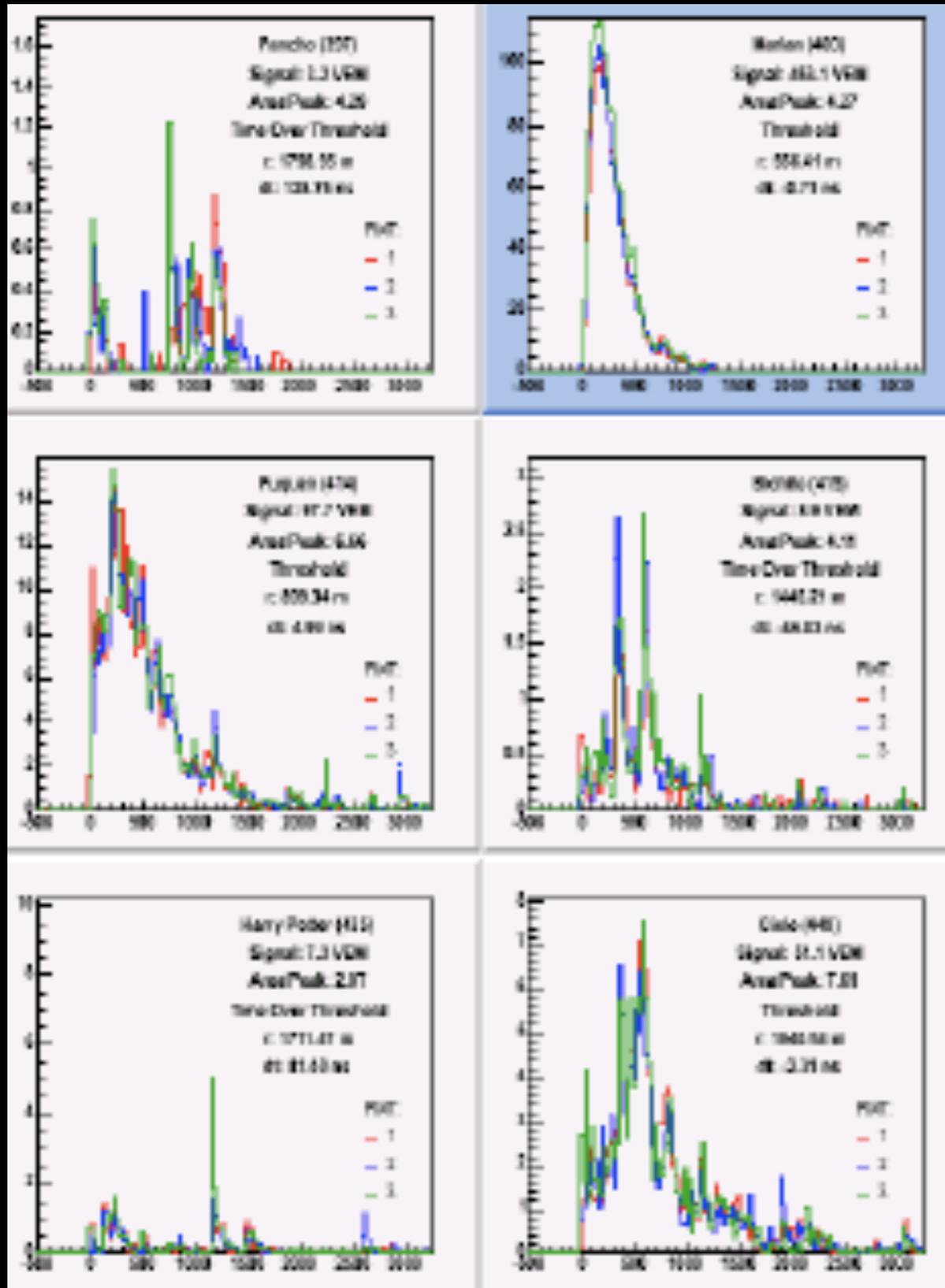

## TELESCOPE ARRAY

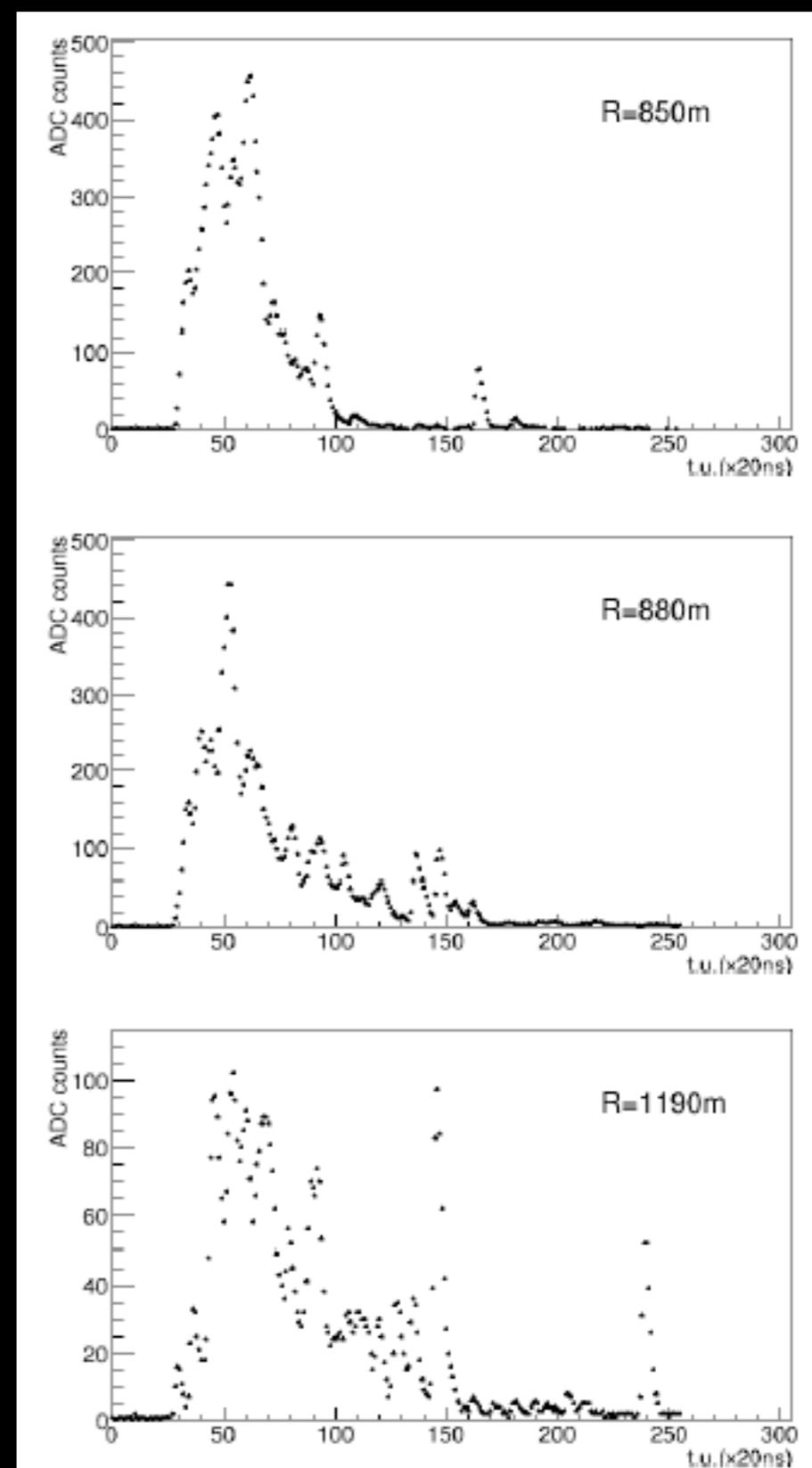

# Calibration of surface detectors

**AUGER**

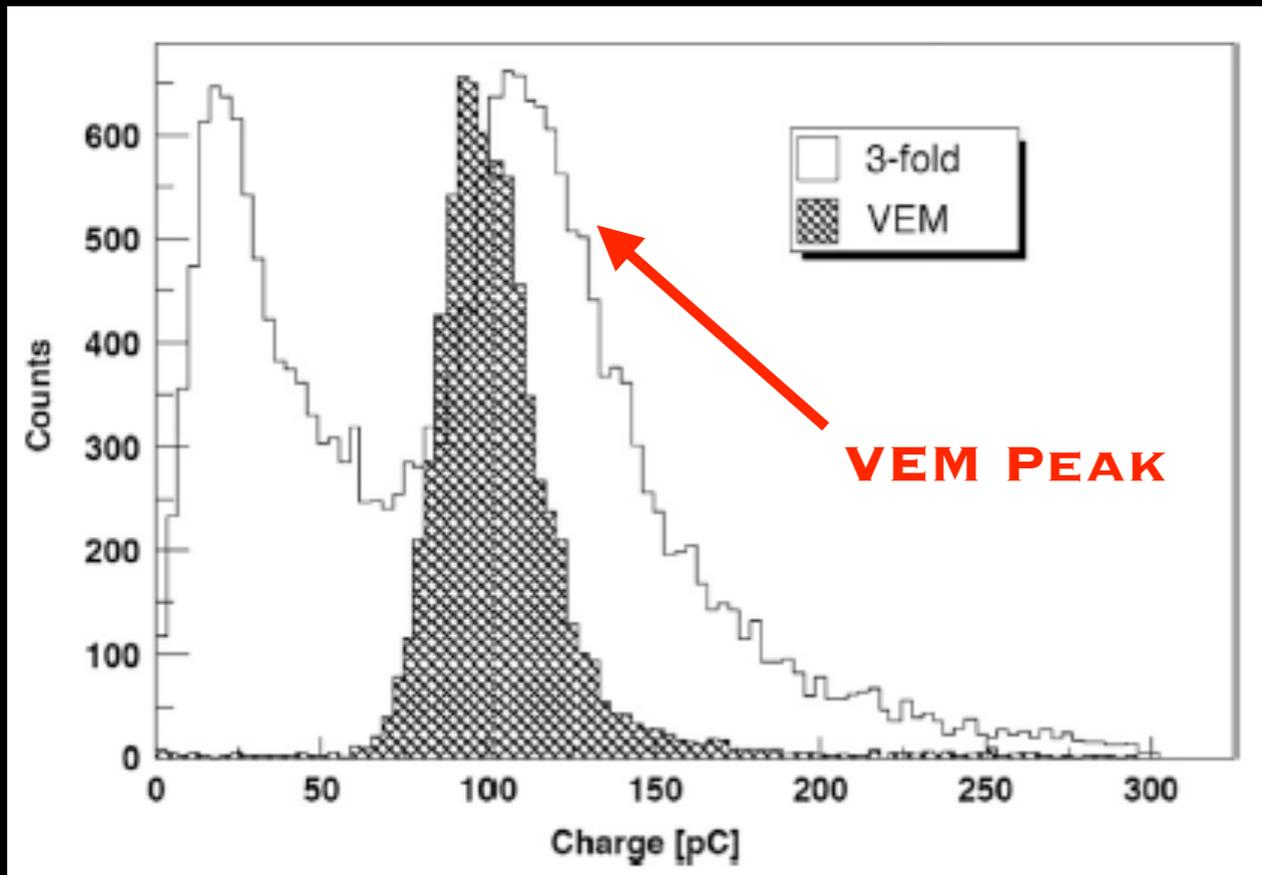

**TELESCOPE ARRAY**

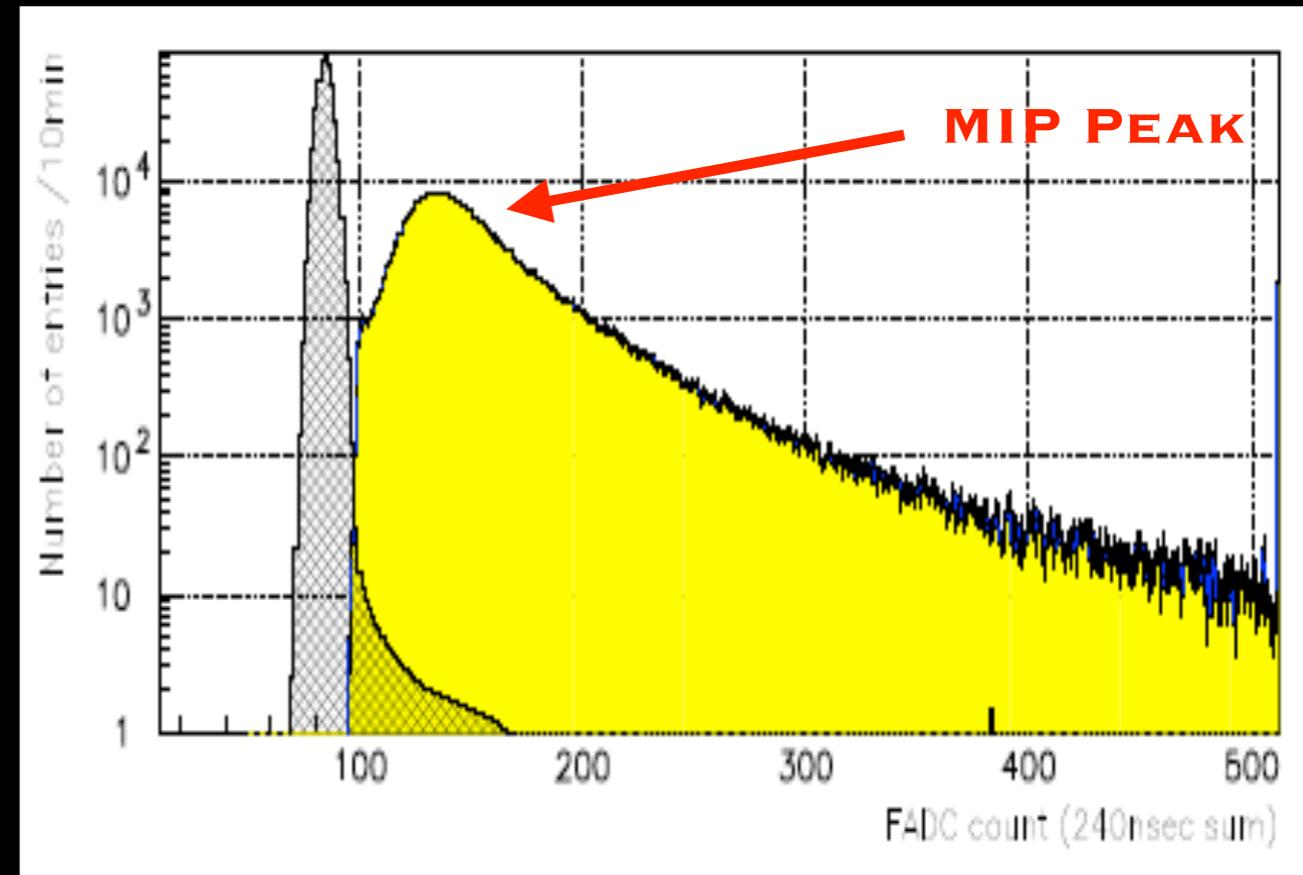

**Charge spectrum obtained (every 10 minutes) when a detector is triggered (at a low-threshold) by the coincidence among the PMTs (VEM = Vertical Equivalent Muon; MIP = minimum ionizing particle)**

**The PMTs signals are converted to number of particles by using “natural” muons (residual of low-energy showers absorbed high in the atmosphere: rate  $\approx 200$  Hz/m<sup>2</sup> )**

# Finally: EAS seen by the surface detectors

**AUGER**

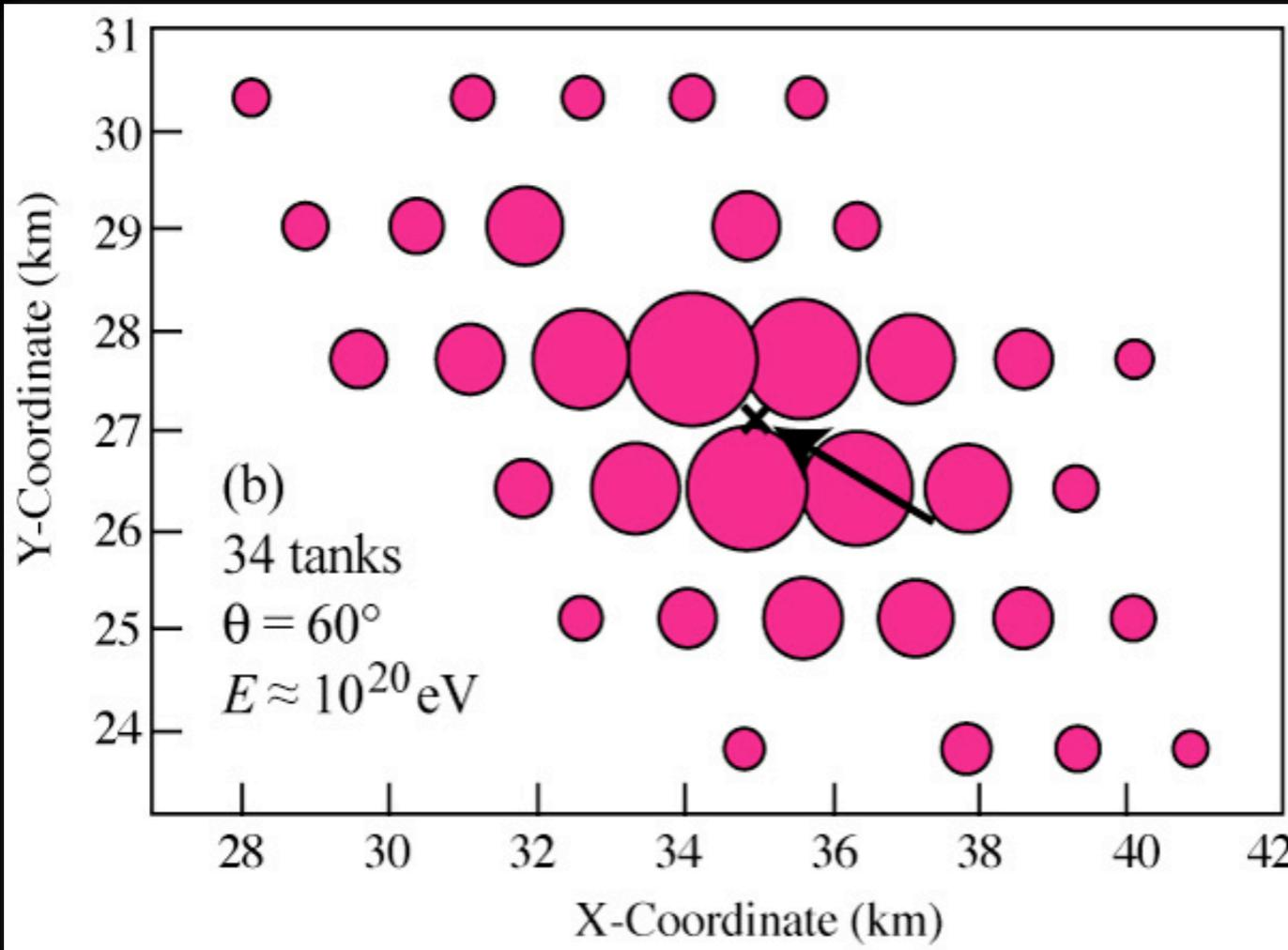

**TELESCOPE ARRAY**

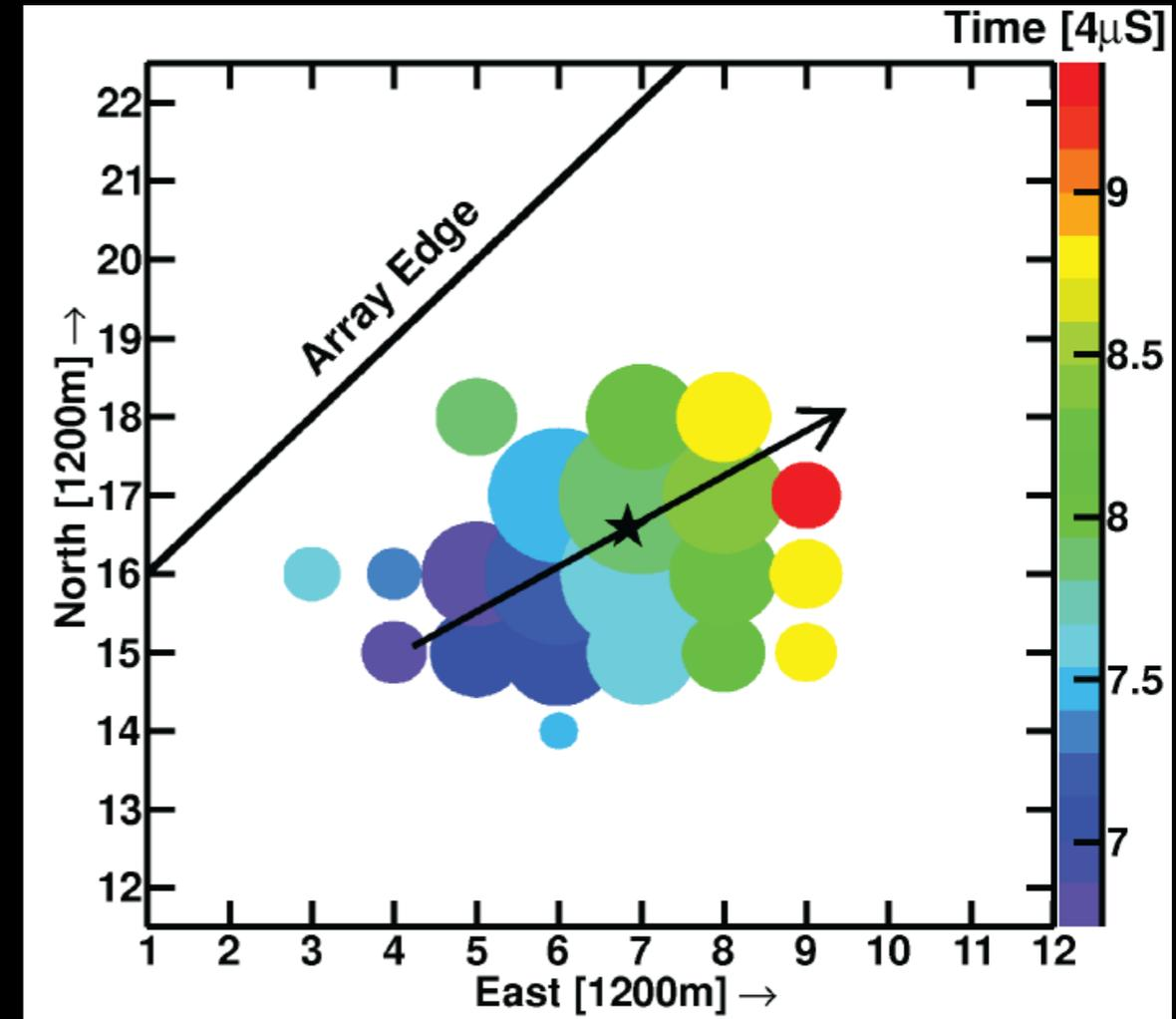

*The dimension of the circles is proportional to the number of detected particles*

**SD “photographs” the footprint of the shower at ground**

# Finally: EAS seen by the surface detectors

**AUGER**

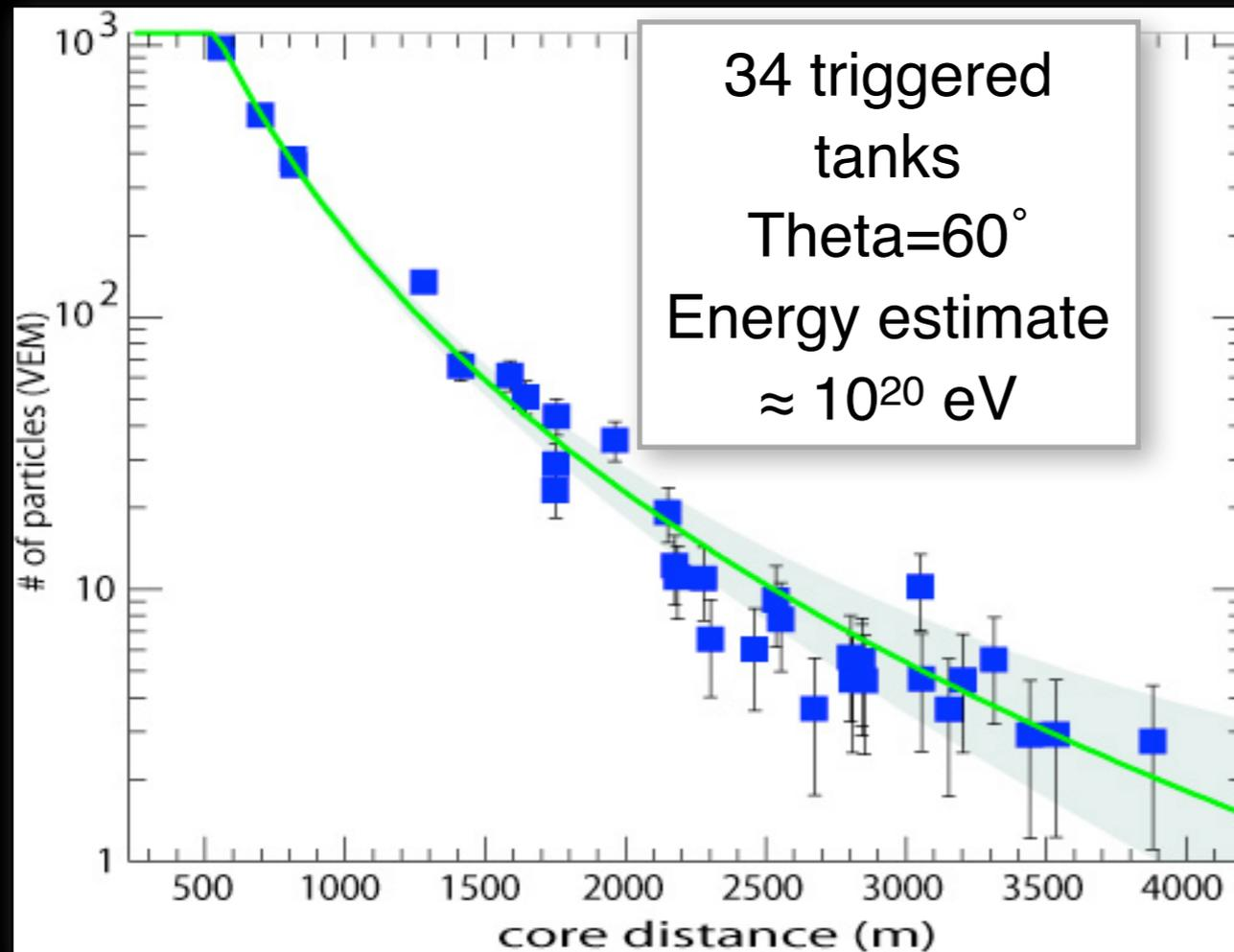

**TELESCOPE ARRAY**

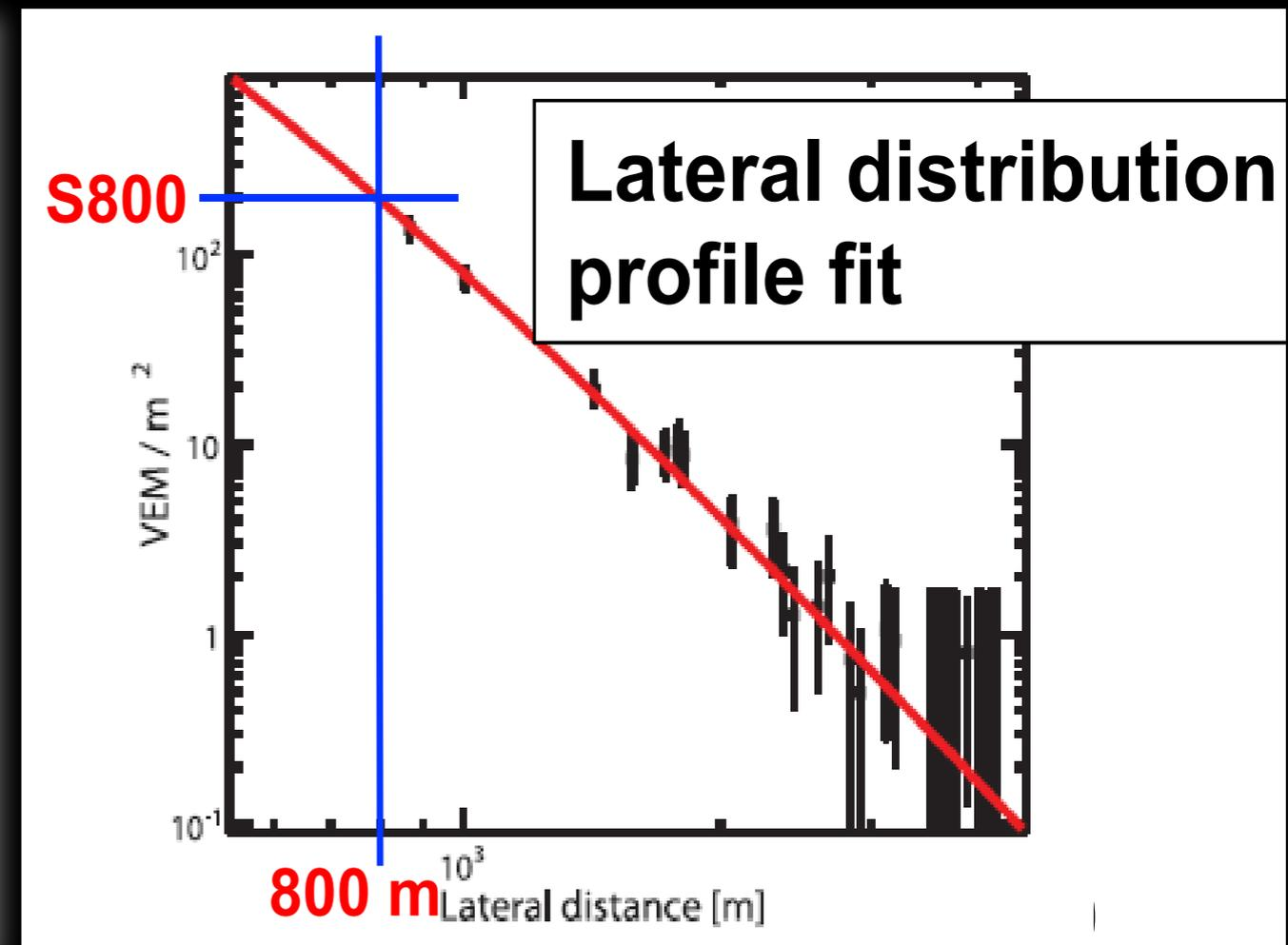

*Distribution of EAS particles as a function of the distance from the core*

**SD measures the lateral distribution of particles**



# Auger and TA fluorescence detectors

**AUGER**

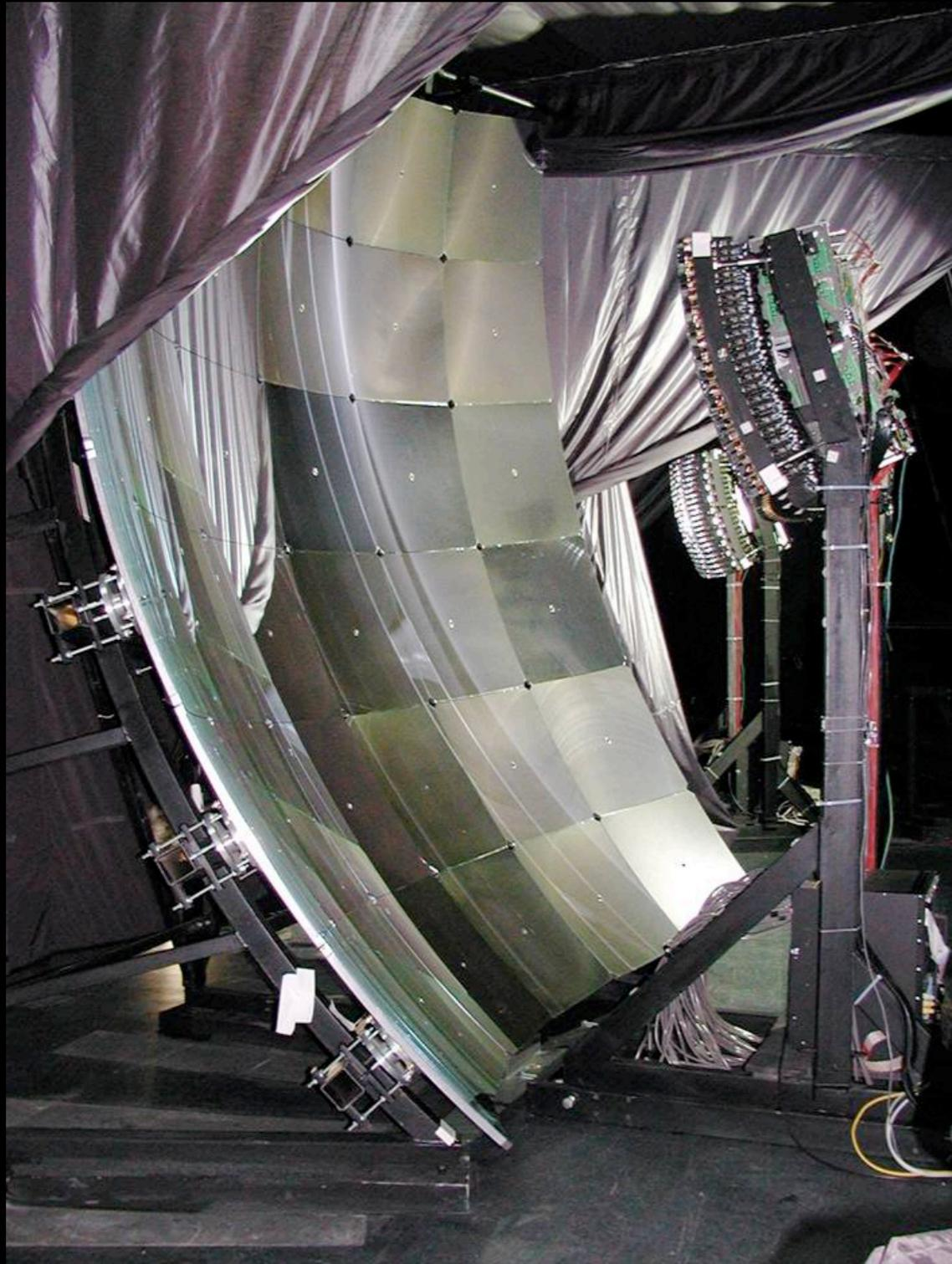

**3.4 M SEGMENTED MIRROR  
440 PMTS CAMERA  
30° x 30° FOV**

**TELESCOPE ARRAY**

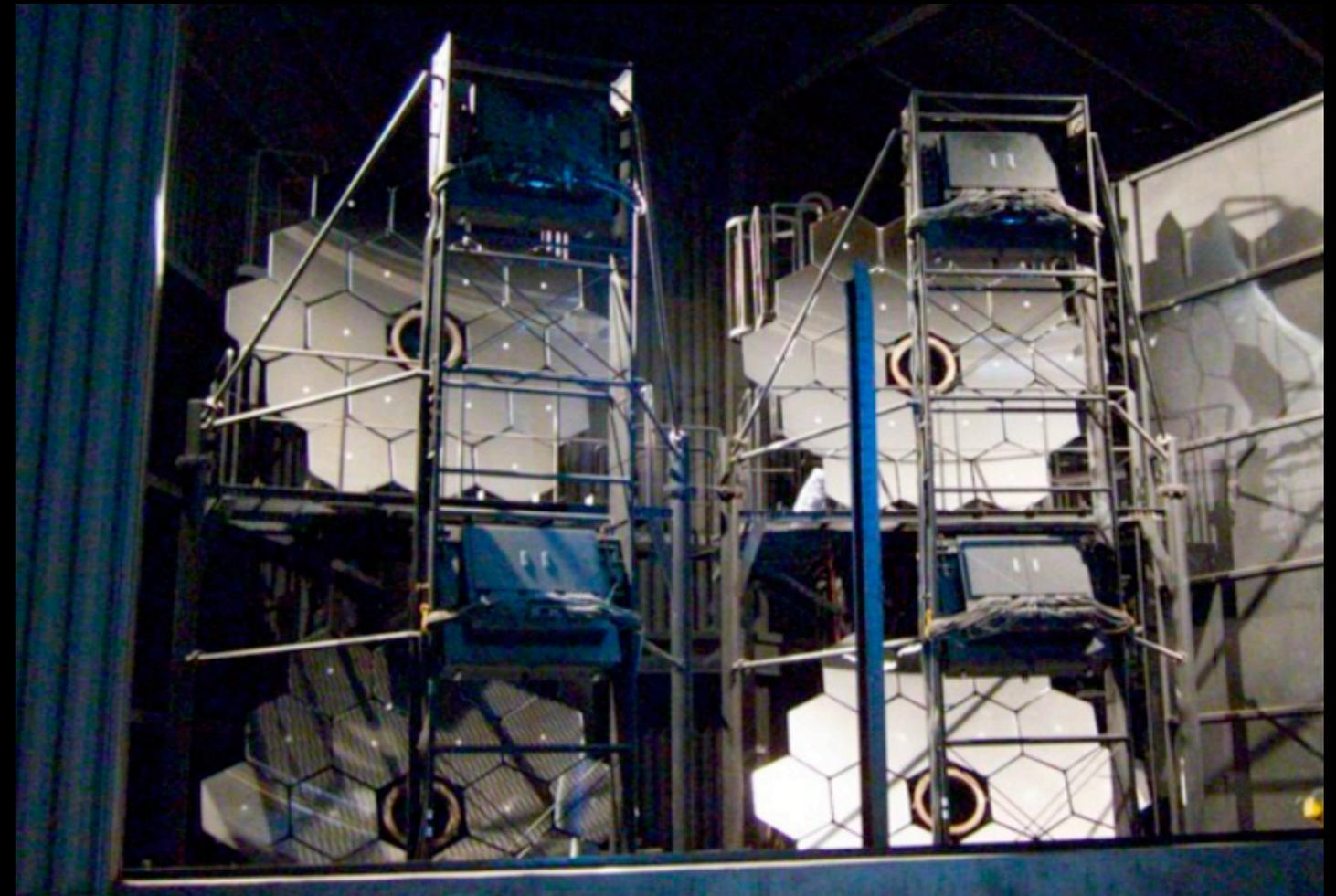

**3 M SEGMENTED MIRROR  
256 PMTS CAMERA  
15° x 18° FOV**

# EAS signals in fluorescence detectors

*Examples of real FADC traces (sorry: Auger only ;-)*

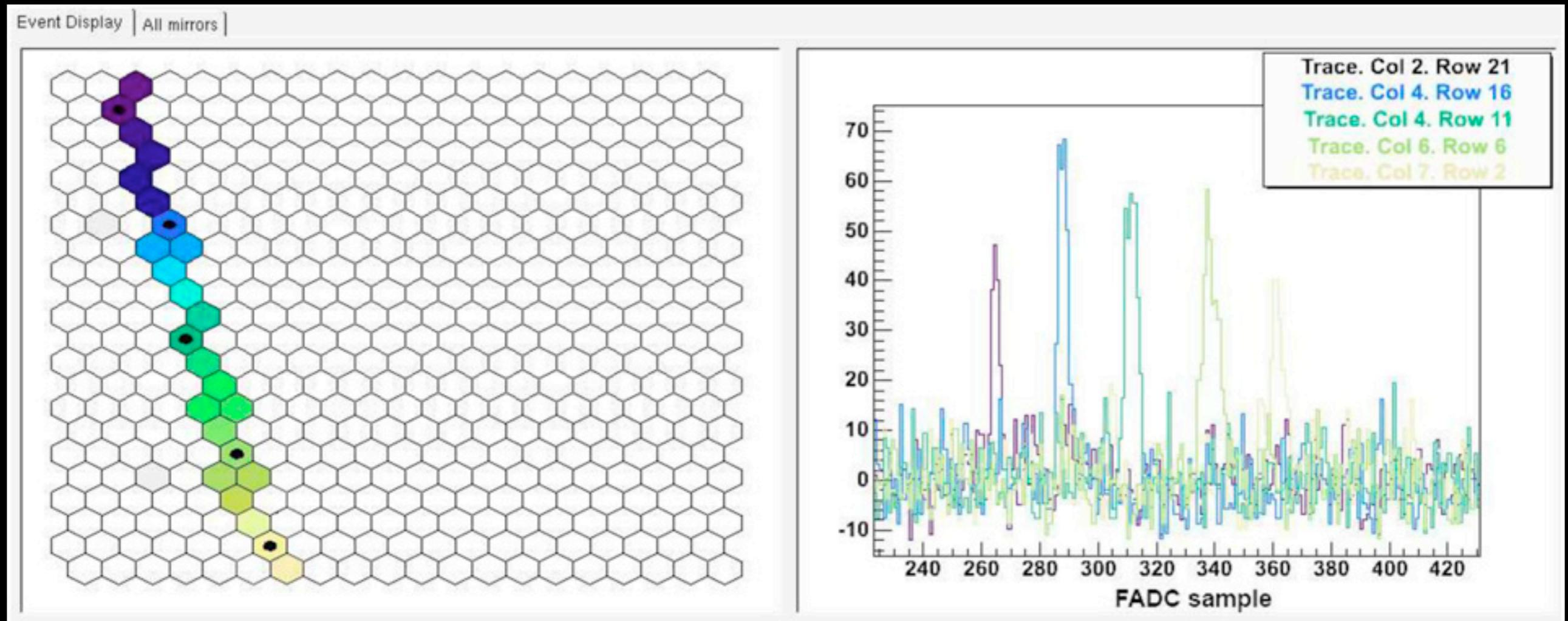

*Pattern of triggered pixels (color code: dark=earlier; light=later)*

*FADC traces of the triggered PMTs (black dots in the left panel)*

**The PMTs signals are digitized by Fast Analog-to-Digital Converters (FADC), with a sampling time of 100 ns.**

**When the signals are above a certain threshold in at least 5 pixels (PMTs) within a certain time, the DAQ starts**

# Calibration of fluorescence detectors

## AUGER

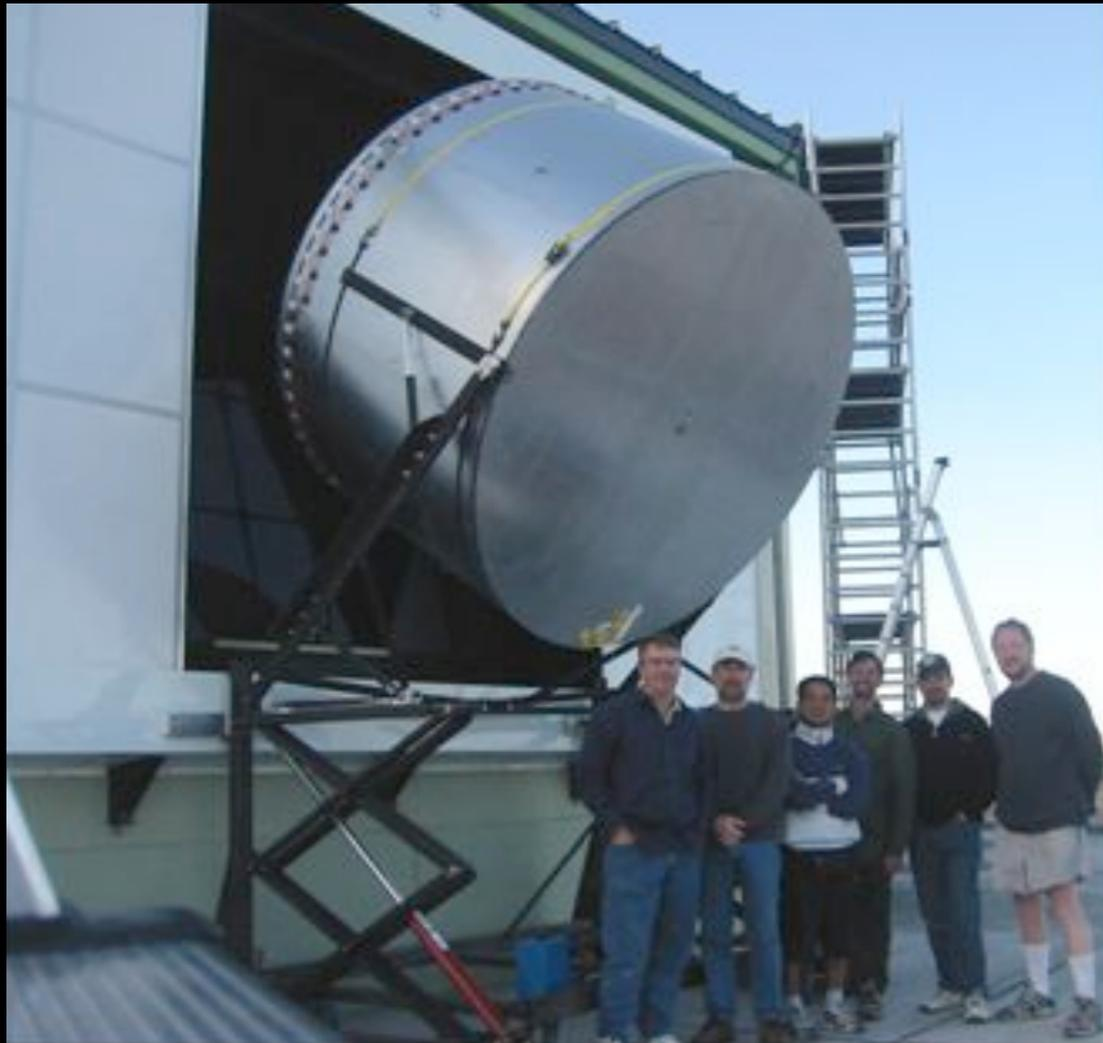

***A calibrated large-diameter, drum-shaped, light source provides an absolute, end-to-end calibration***

## TELESCOPE ARRAY

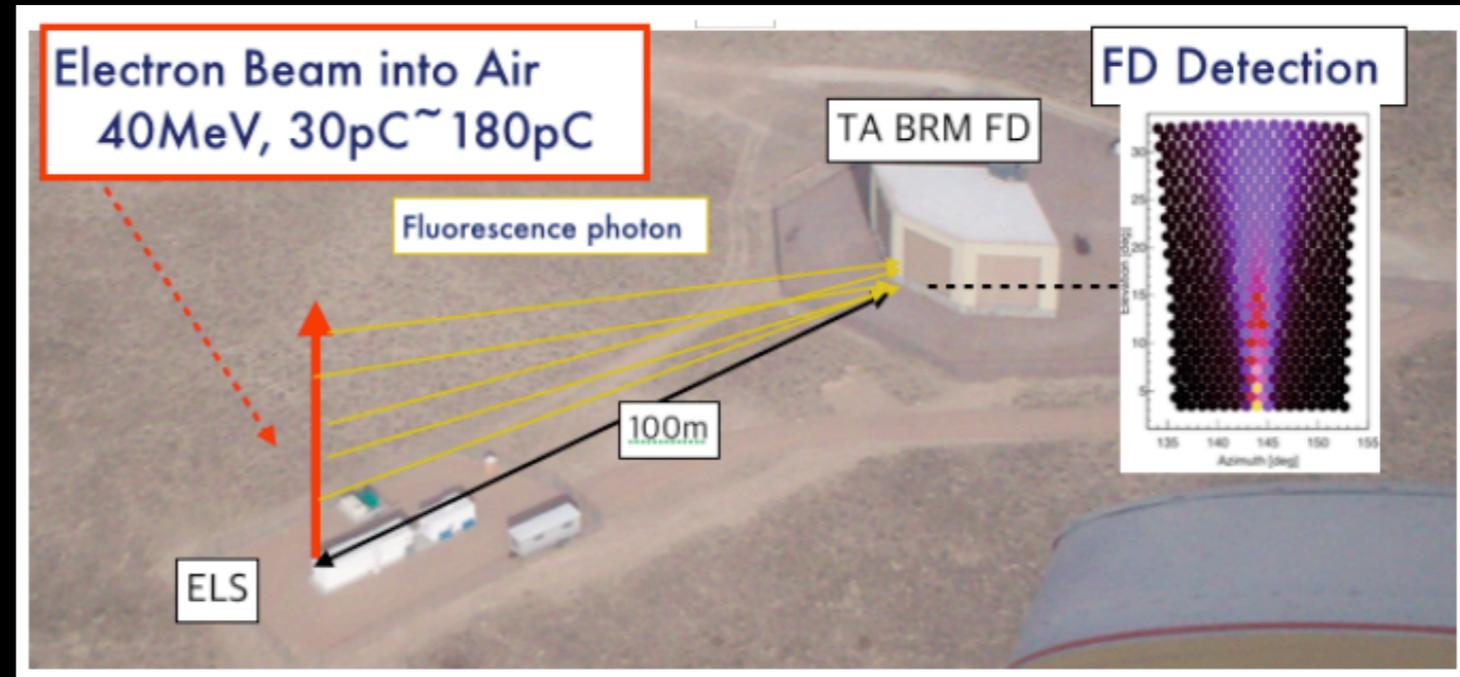

***The Electron Light Source is an electron linear accelerator serving as an absolute calibration. The ELS fires a vertical 40 MeV electron-beam of duration  $1 \mu\text{s}$  at a repetition rate of 0.5 Hz.***

**The PMTs signals are converted to number of photons by illuminating the cameras with well-calibrated light sources**

# Auger and TA atmospheric monitoring

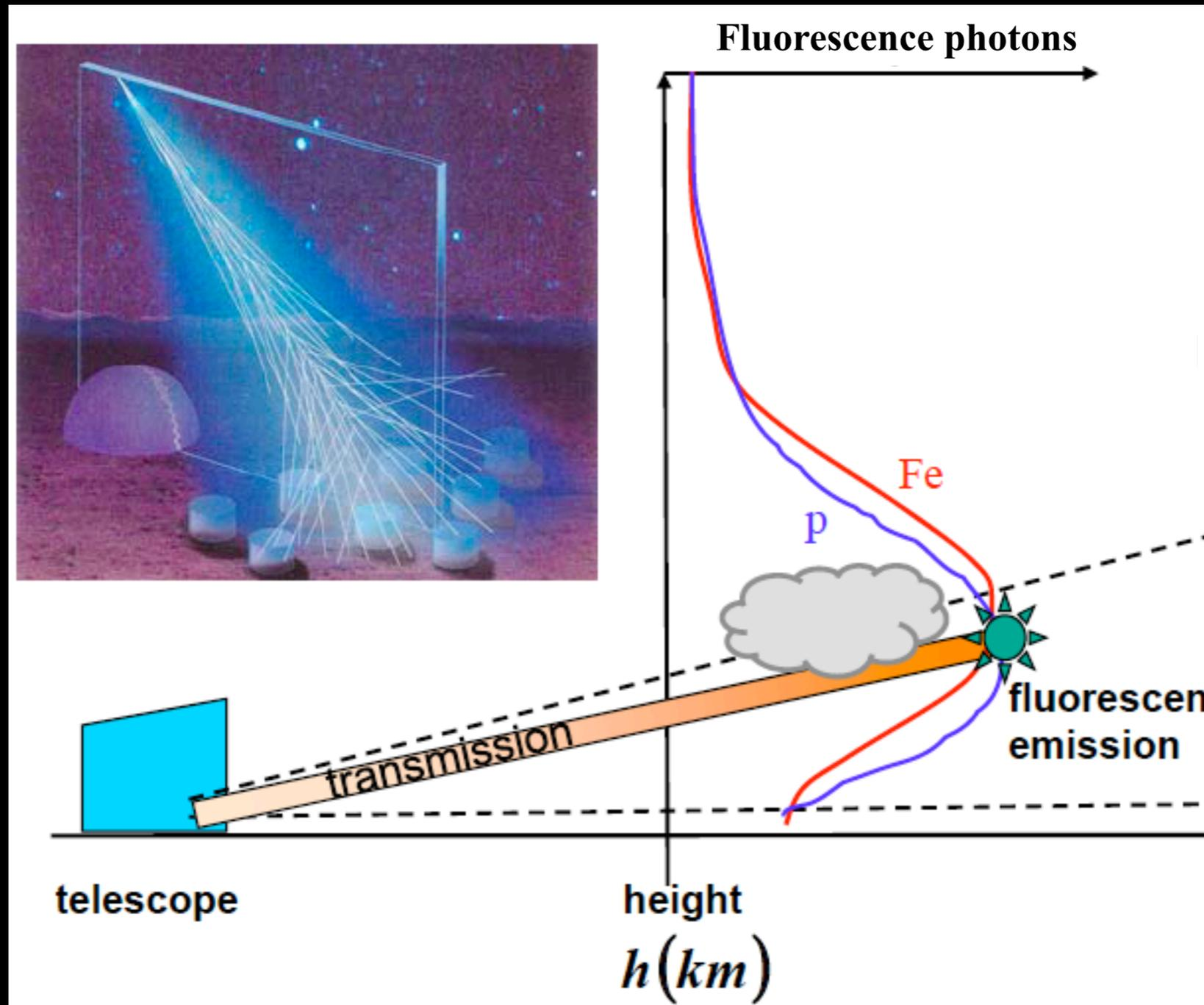

**Also, the atmospheric transmission between the air-shower and the FD must be taken into account to properly reconstruct the light generated along the shower axis from the light recorded at the telescope(s)**

# Auger and TA atmospheric monitoring

*Clouds and aerosols play a major role in the optical transmission*

## AUGER

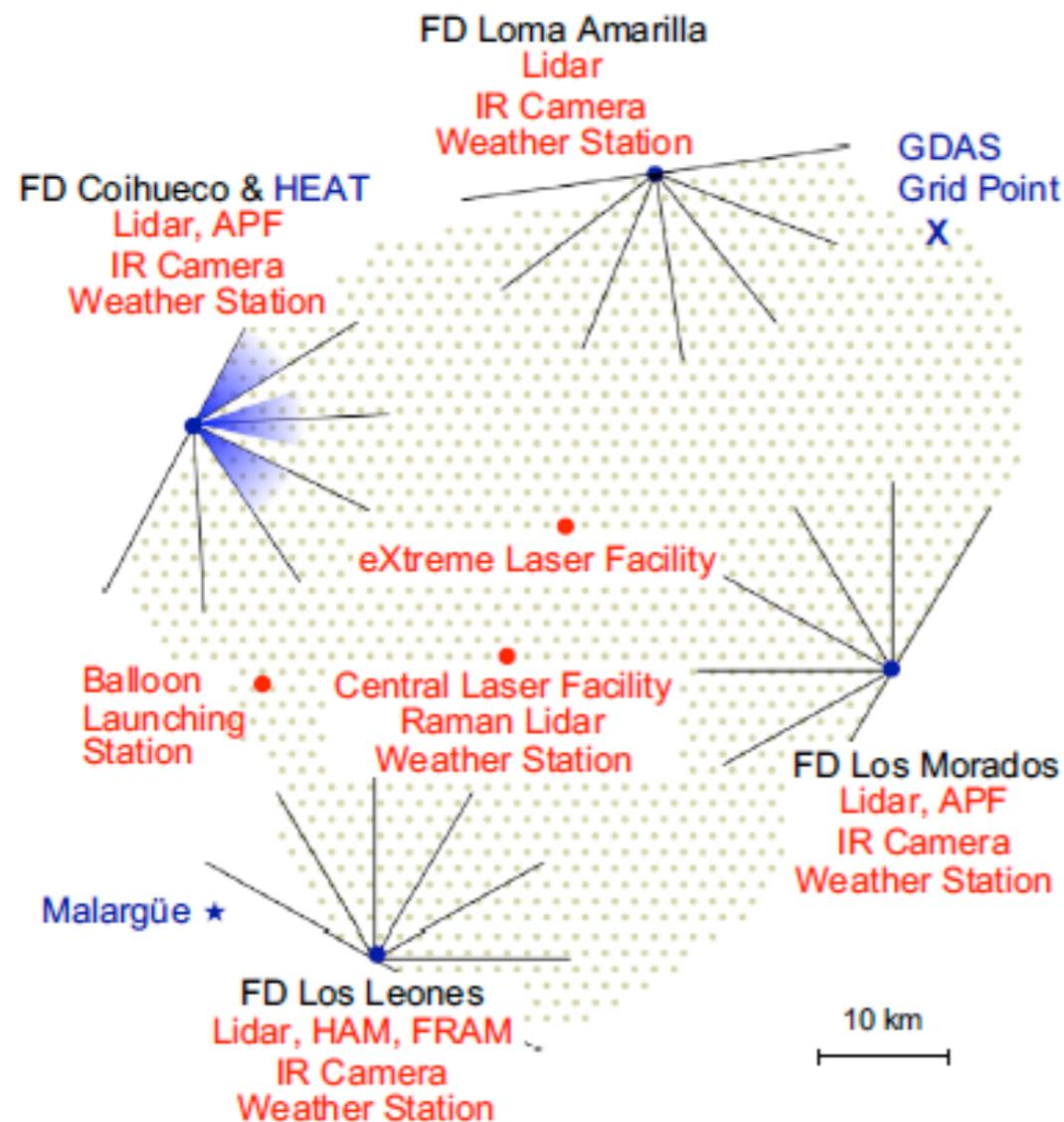

## TELESCOPE ARRAY

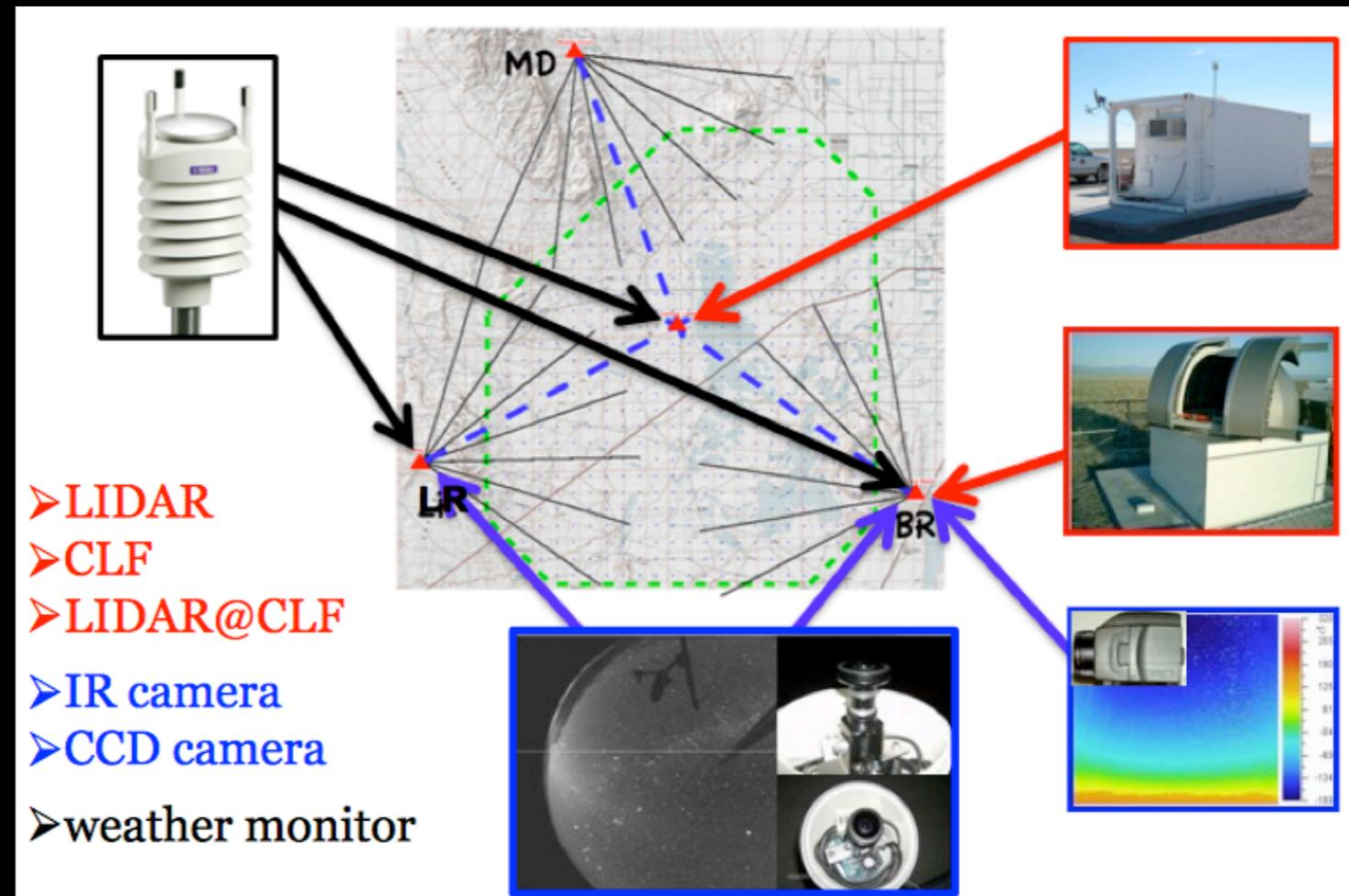

**Weather stations** measure P, T and humidity.

**Infrared cameras and LIDARs** monitor the cloud coverage.

**Lasers and LIDARs** allow to determine the aerosols optical-depth profile

# Finally: EAS seen by the fluorescence detectors

**AUGER**

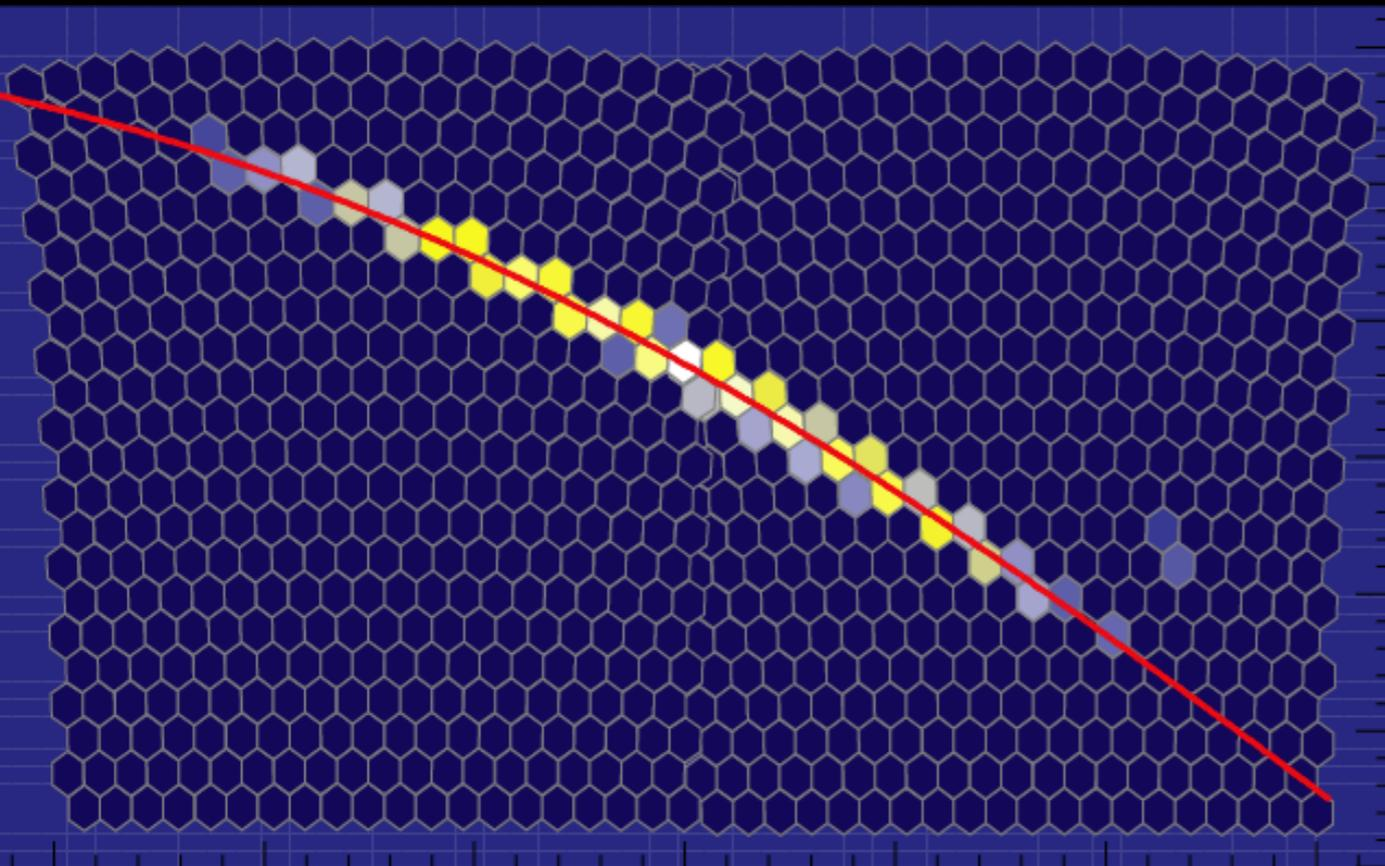

**TELESCOPE ARRAY**

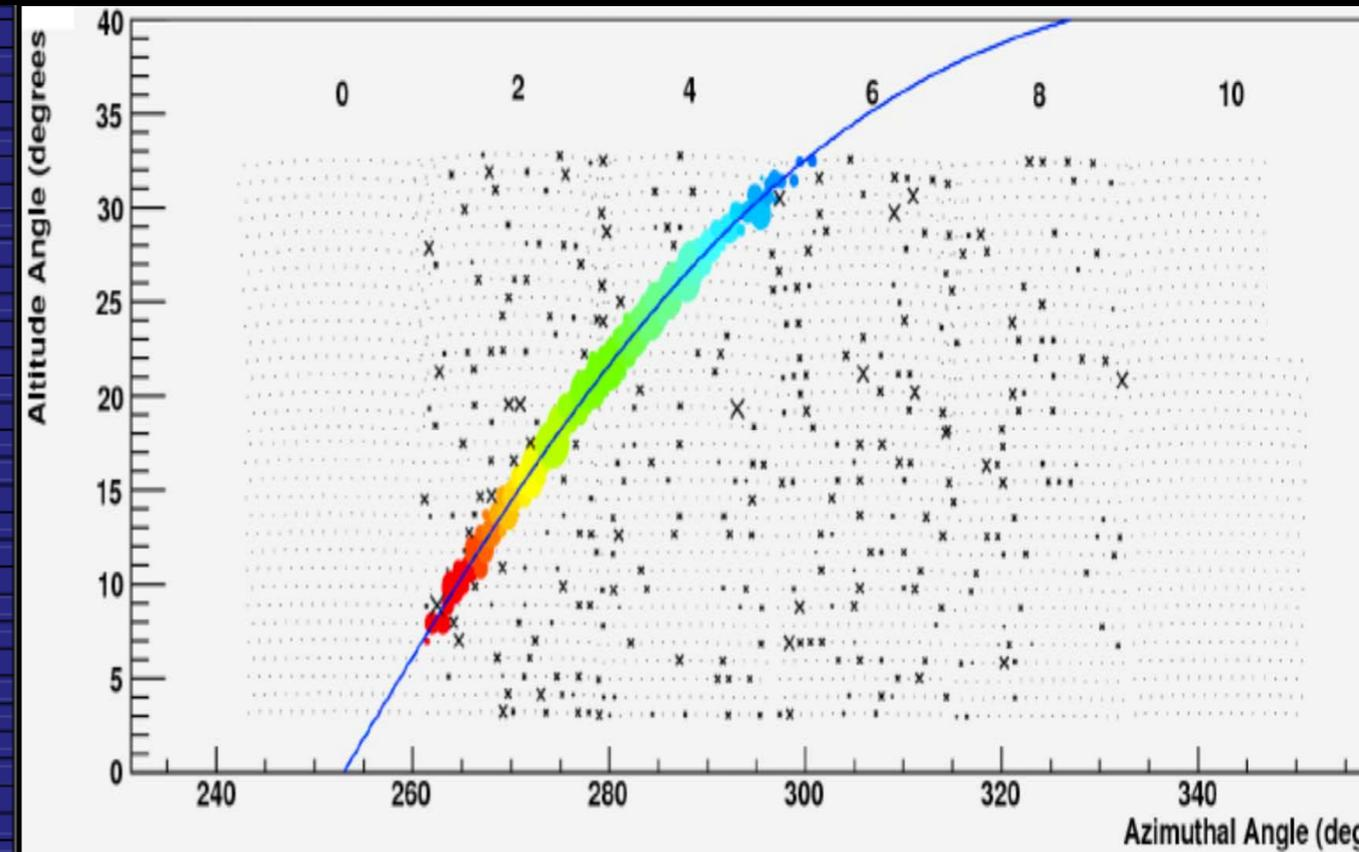

**FD “photographs” the passage of the shower in atmosphere**

# Finally: EAS seen by the fluorescence detectors

**AUGER**

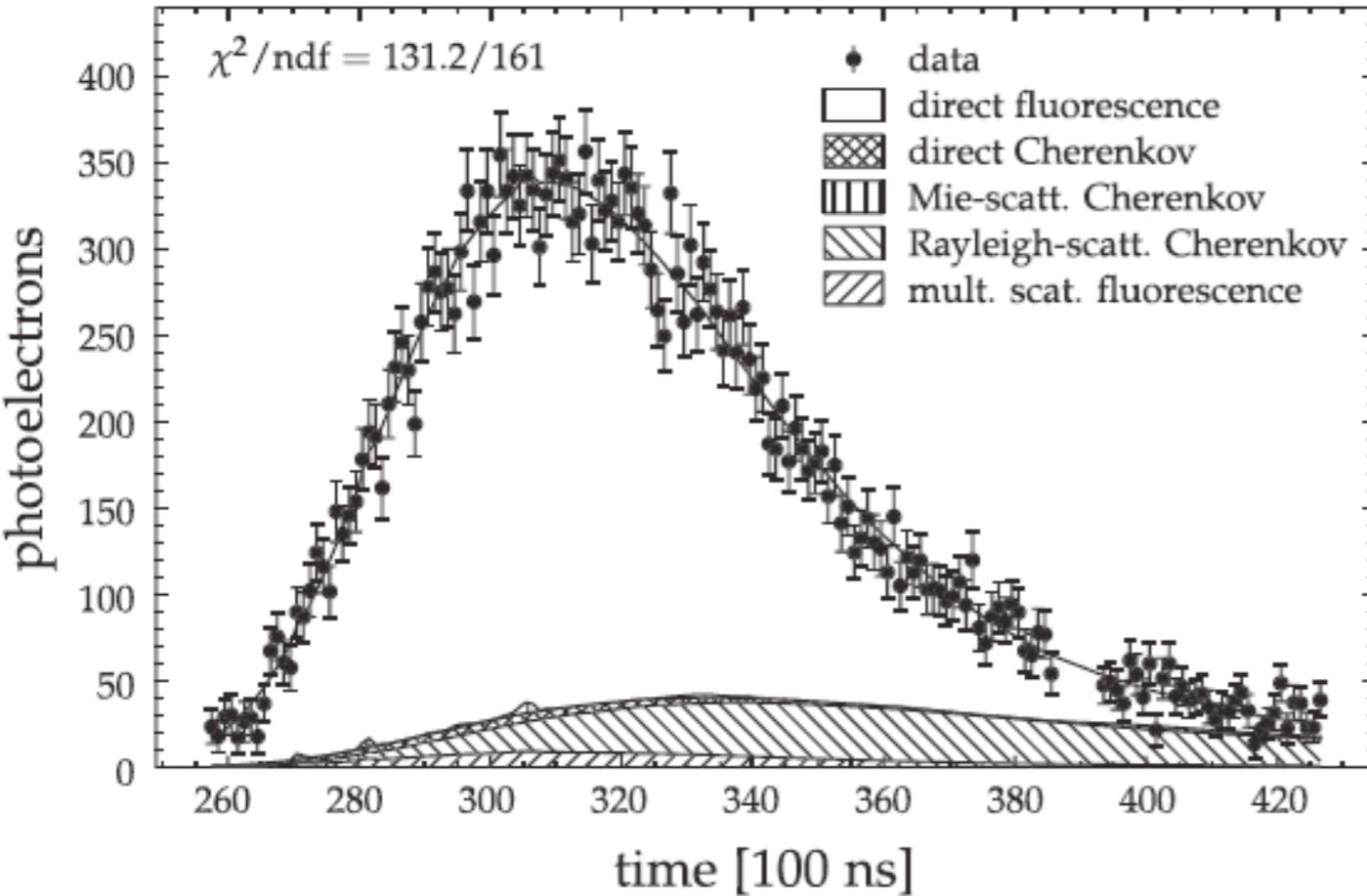

**TELESCOPE ARRAY**

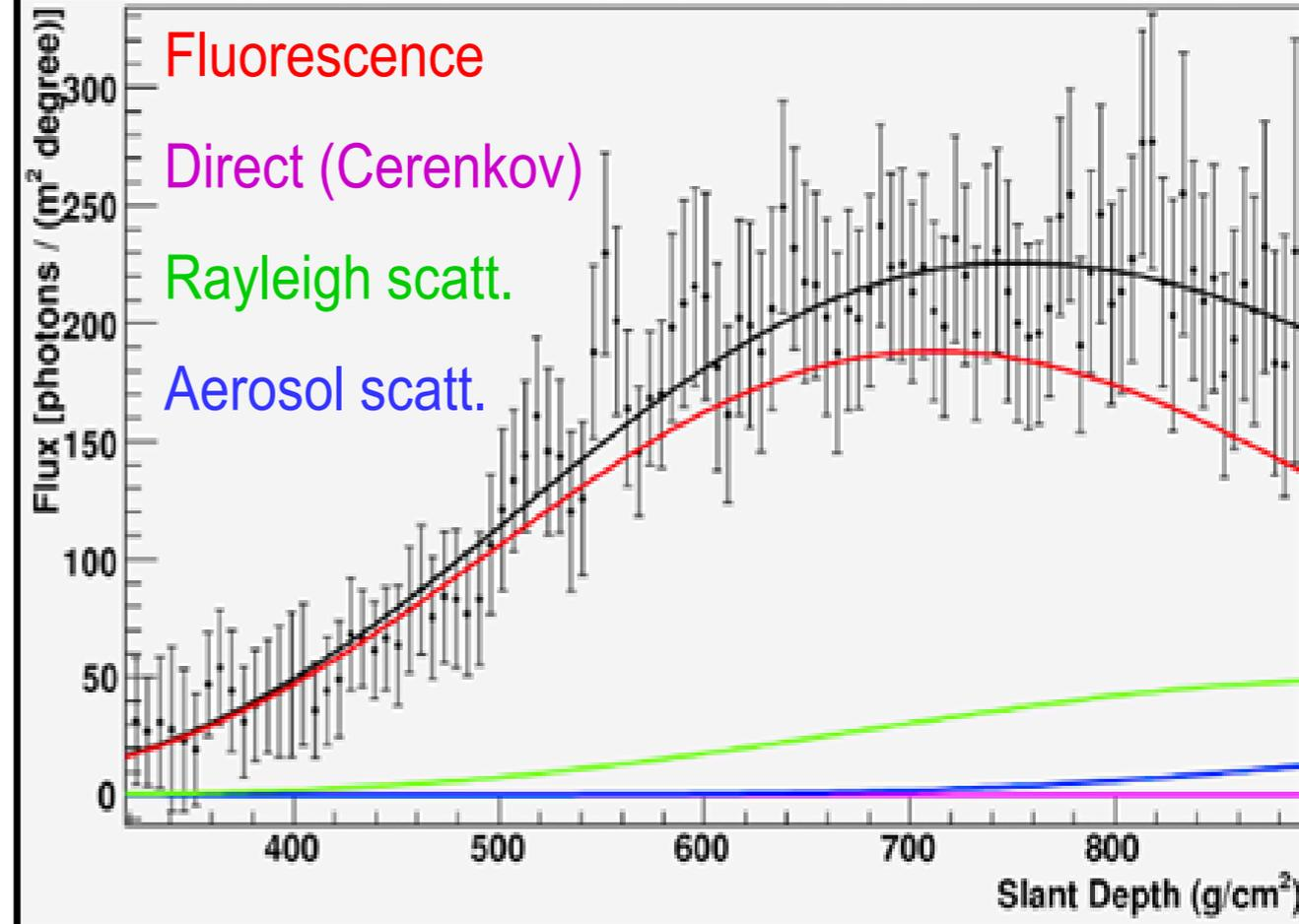

*Light-at-aperture measurements and reconstructed light sources*

**FD measures the longitudinal development in atmosphere**

***Two exemplary cases: the Pierre Auger  
Observatory and the Telescope Array:  
From EAS observables to CR properties***

***The subtlety of the analysis***



# Which information on CRs must we extract from EAS?

*The ultimate aim of EAS detection is the identification of the primary cosmic ray, in terms of*

**Mass/Charge**

**Energy**

**Arrival direction**

**We are dealing with an INDIRECT MEASUREMENT of CRs**

**To infer the properties of the primary particle one needs not only to detect EAS as precisely as possible but also to exploit as carefully as possible the “legacy” that their parents left into them**

# How do we pass from the observed EAS to the CR?

*In a nutshell, aka in one slide*

## SD - FD

### CR ARRIVAL

**DIRECTION:** FROM RELATIVE ARRIVAL TIMES OF SIGNALS AT GROUND DETECTORS, OR FROM THE TIME SEQUENCE OF HIT PMTS AT FLUORESCENCE DETECTORS

Extensive Air Shower

**FD**  
**ENERGY AND XMAX (MASS PROXY):** FROM THE LONGITUDINAL DISTRIBUTION OF THE FLUORESCENCE LIGHT EMITTED BY EAS

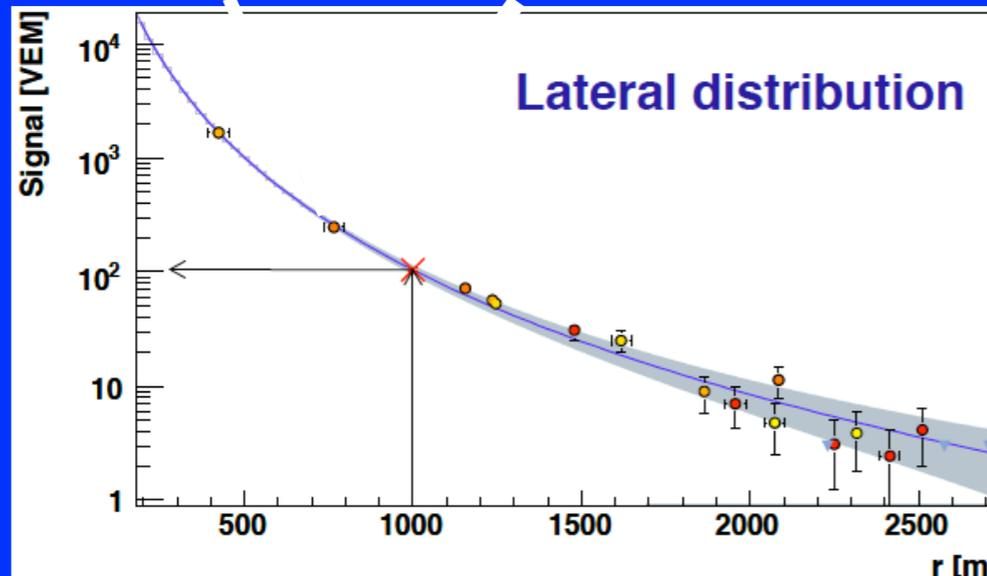

**SD**  
**ENERGY PROXY:** FROM THE DISTRIBUTION/ NUMBER OF PARTICLES AT GROUND

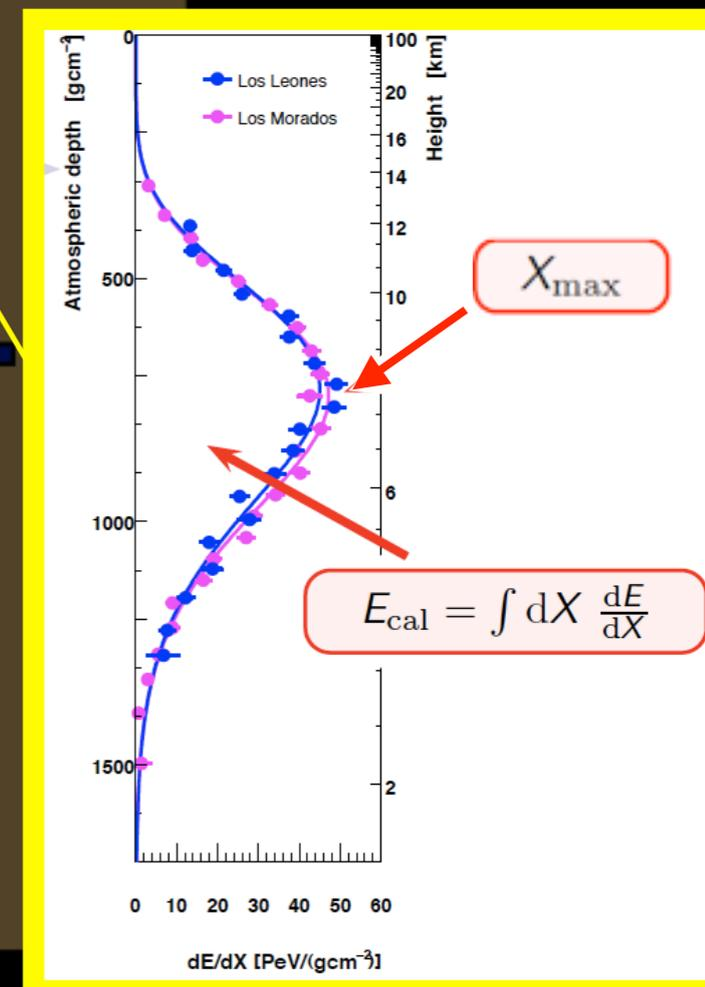

# Let's start from the simplest one: arrival direction

## Surface detectors

**Most straightforward measurement**

**The shower axis preserves the direction of the incoming particle**

**SD determines the arrival direction from the shower front**

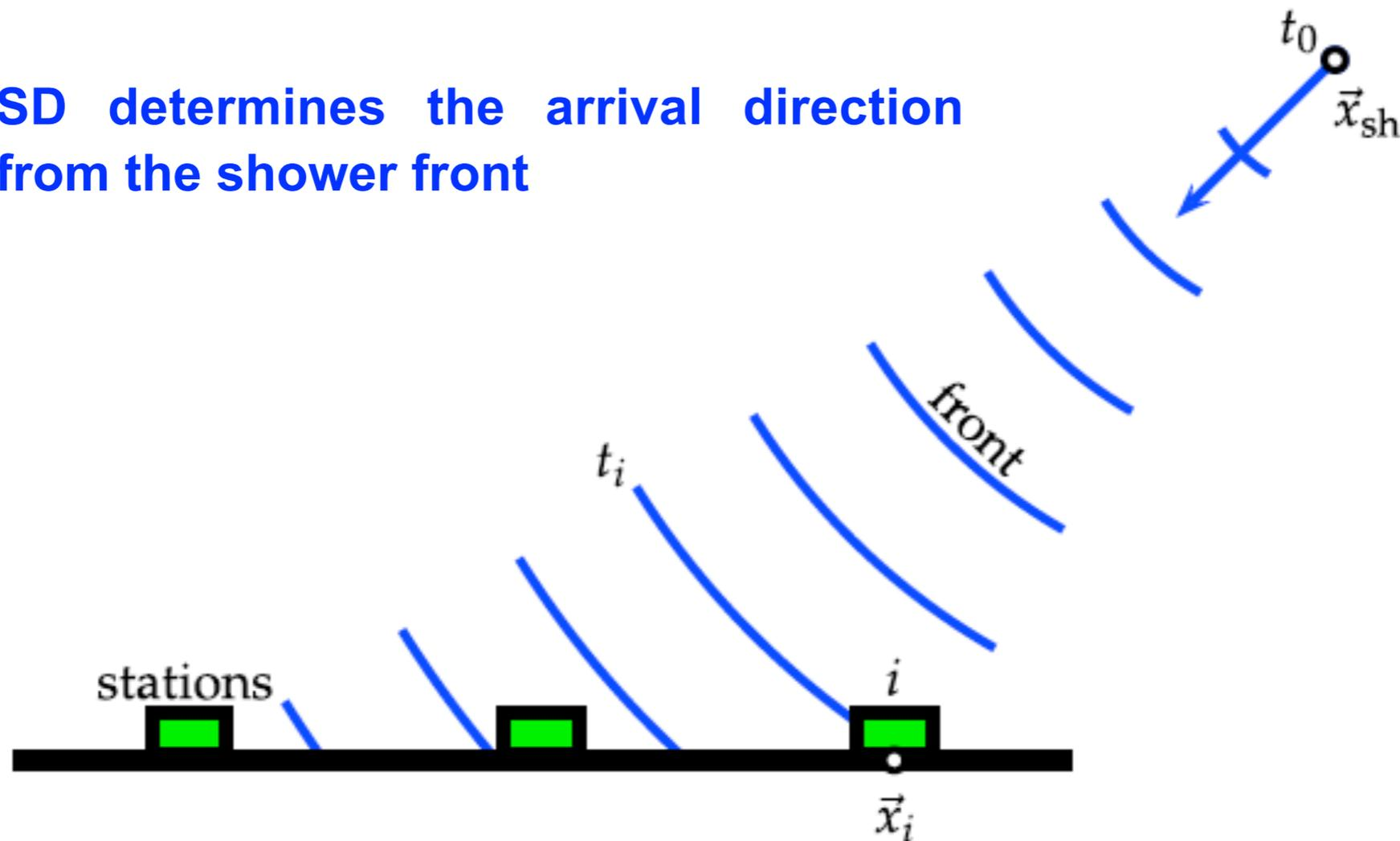

**Time-of-flight technique:**

**Time differences among the arrival times  $t_i$  of shower particles in the different detectors give the arrival direction**

# Measurement of the arrival direction

*In practice*

**AUGER**

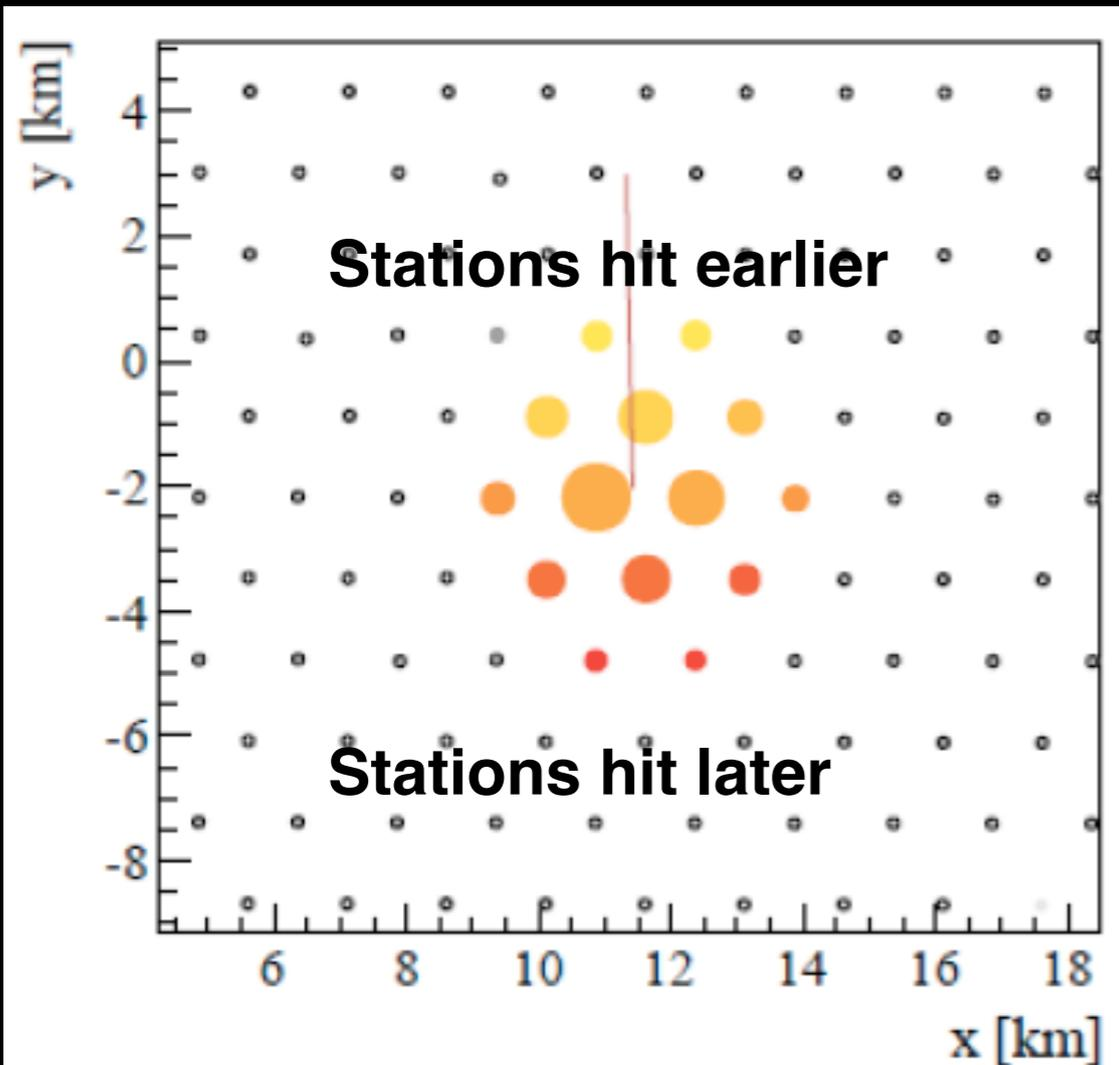

**TELESCOPE ARRAY**

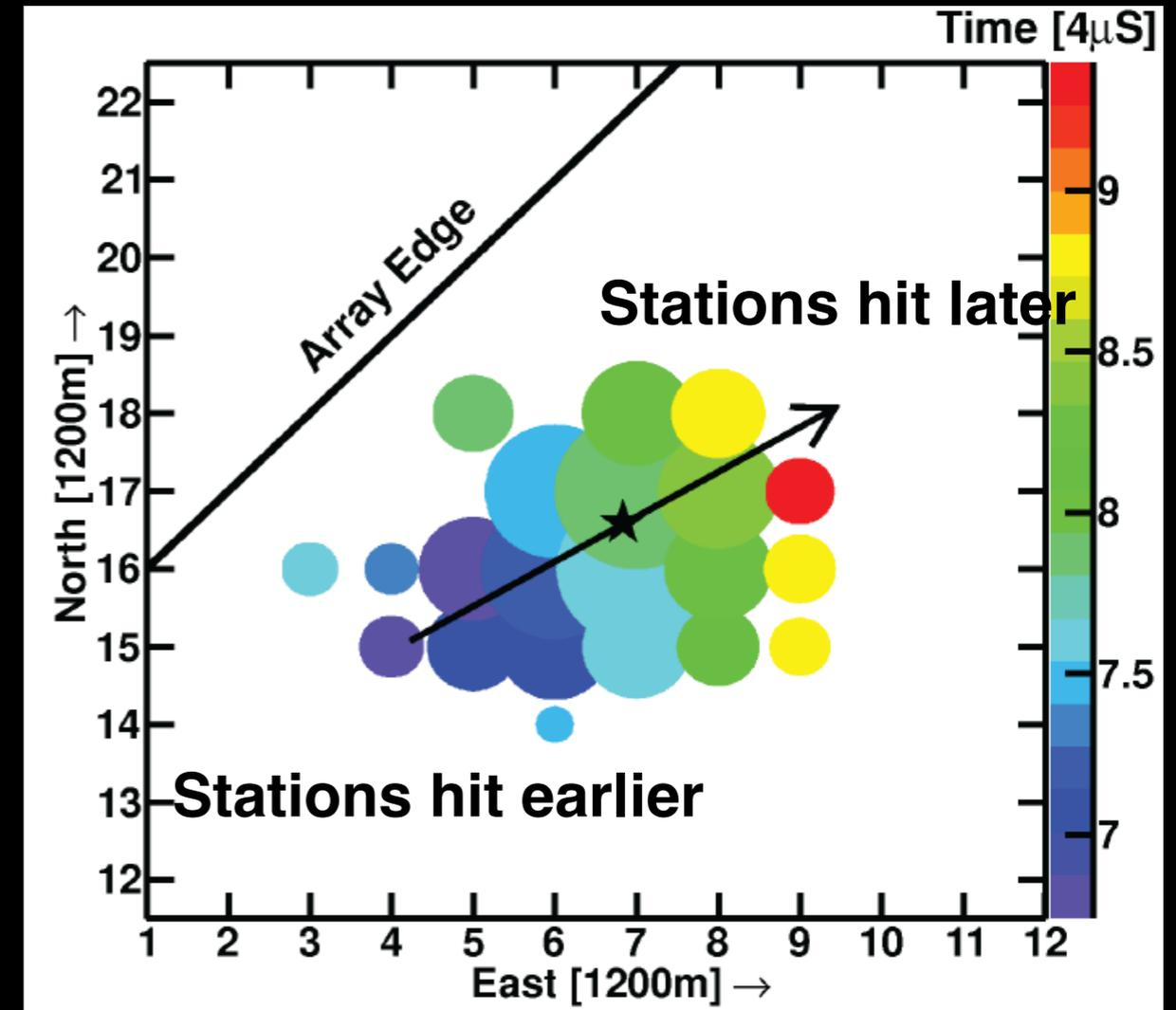

**Arrival direction: estimated by a fit of the shower front (moving at  $c$ ).**  
**If only 3 detectors are triggered: fit to a plane front**  
**If more: fit to a spherical front**

# Arrival direction (angular) resolution

## *SD angular resolution*

**AUGER**

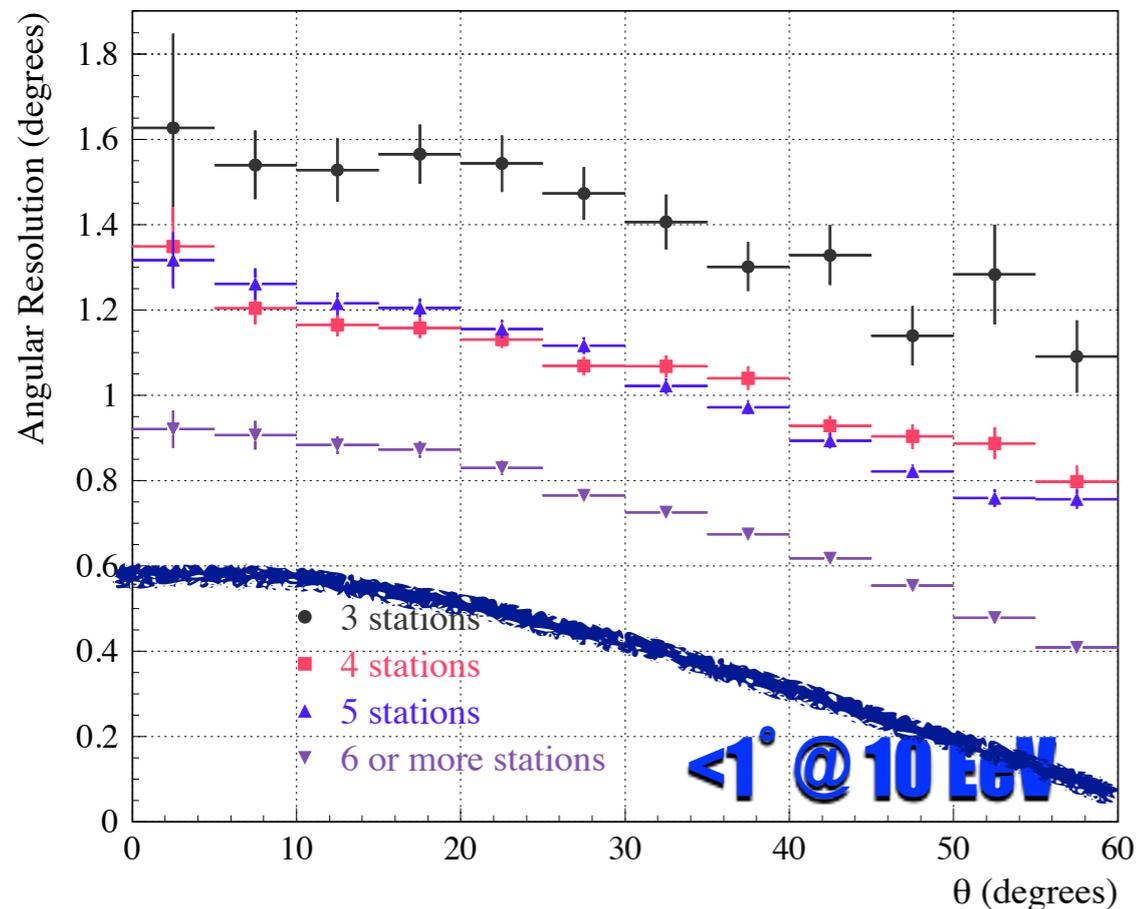

**TELESCOPE ARRAY**

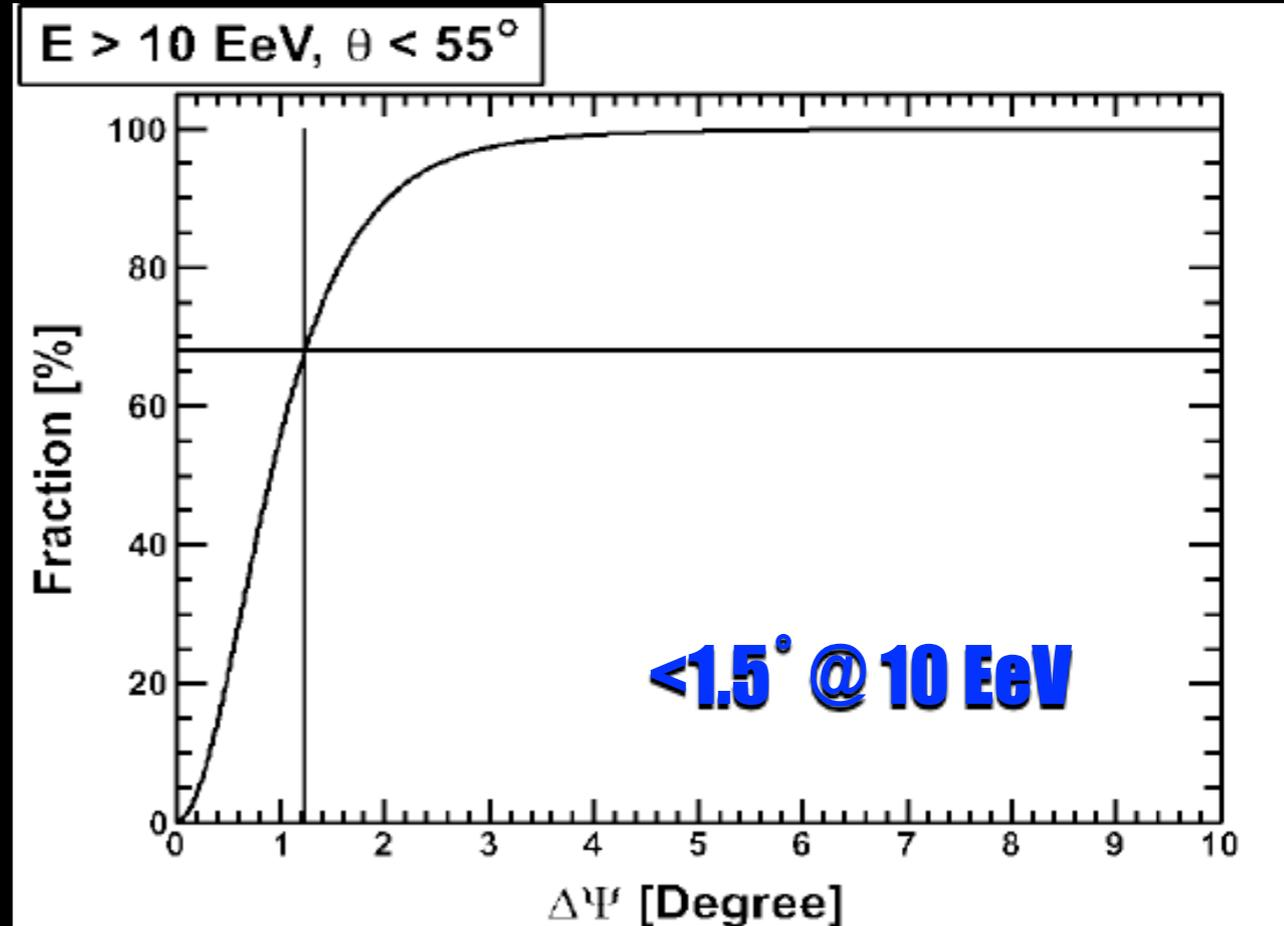

**Angular resolution: determined by the shower-front fit, on an event-by-event basis.**

**It depends on the timing resolution and on the number of triggered detectors**

# Measurement of the arrival direction

## Fluorescence detectors

**FD determines the arrival direction from the shower evolution**

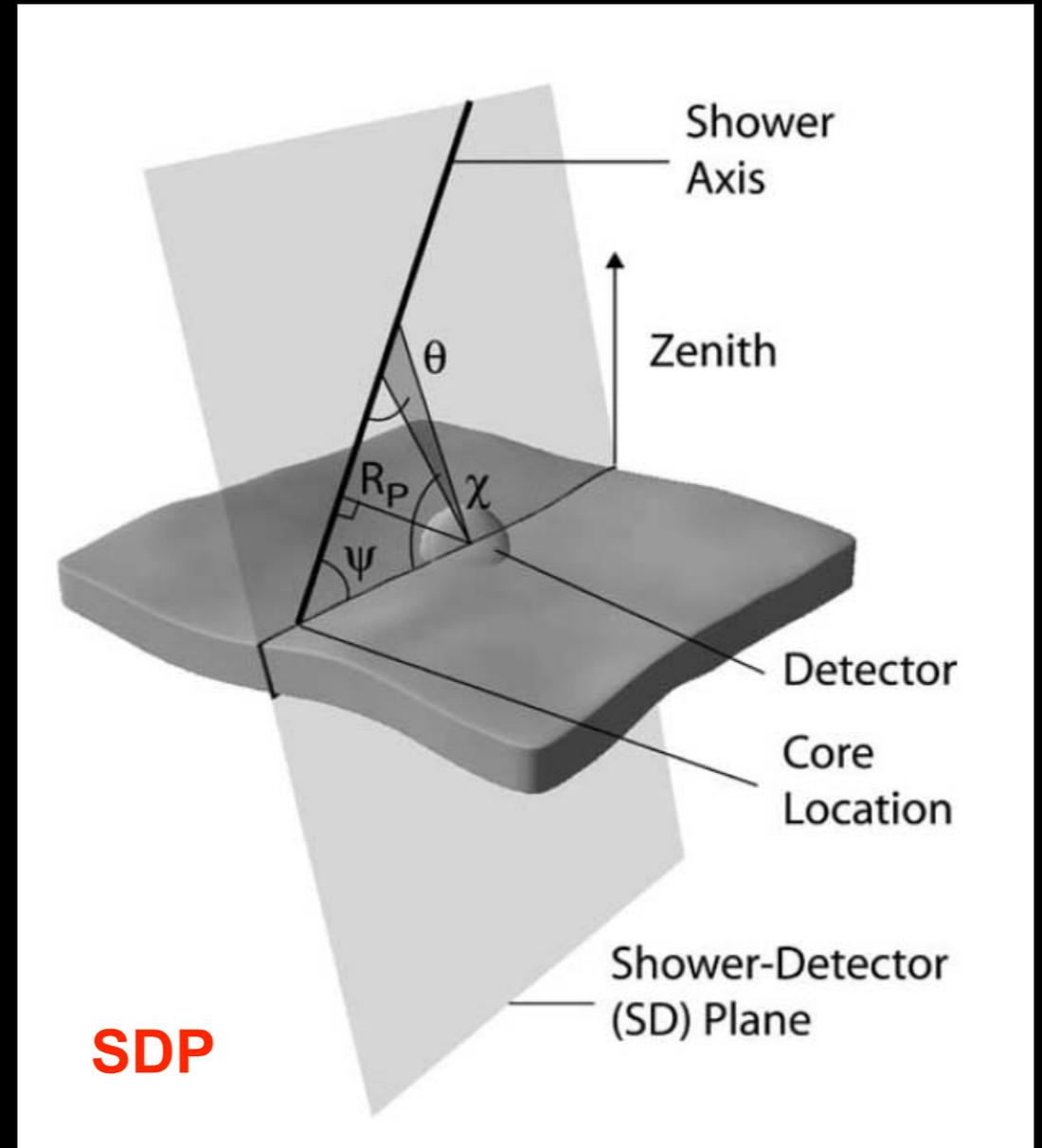
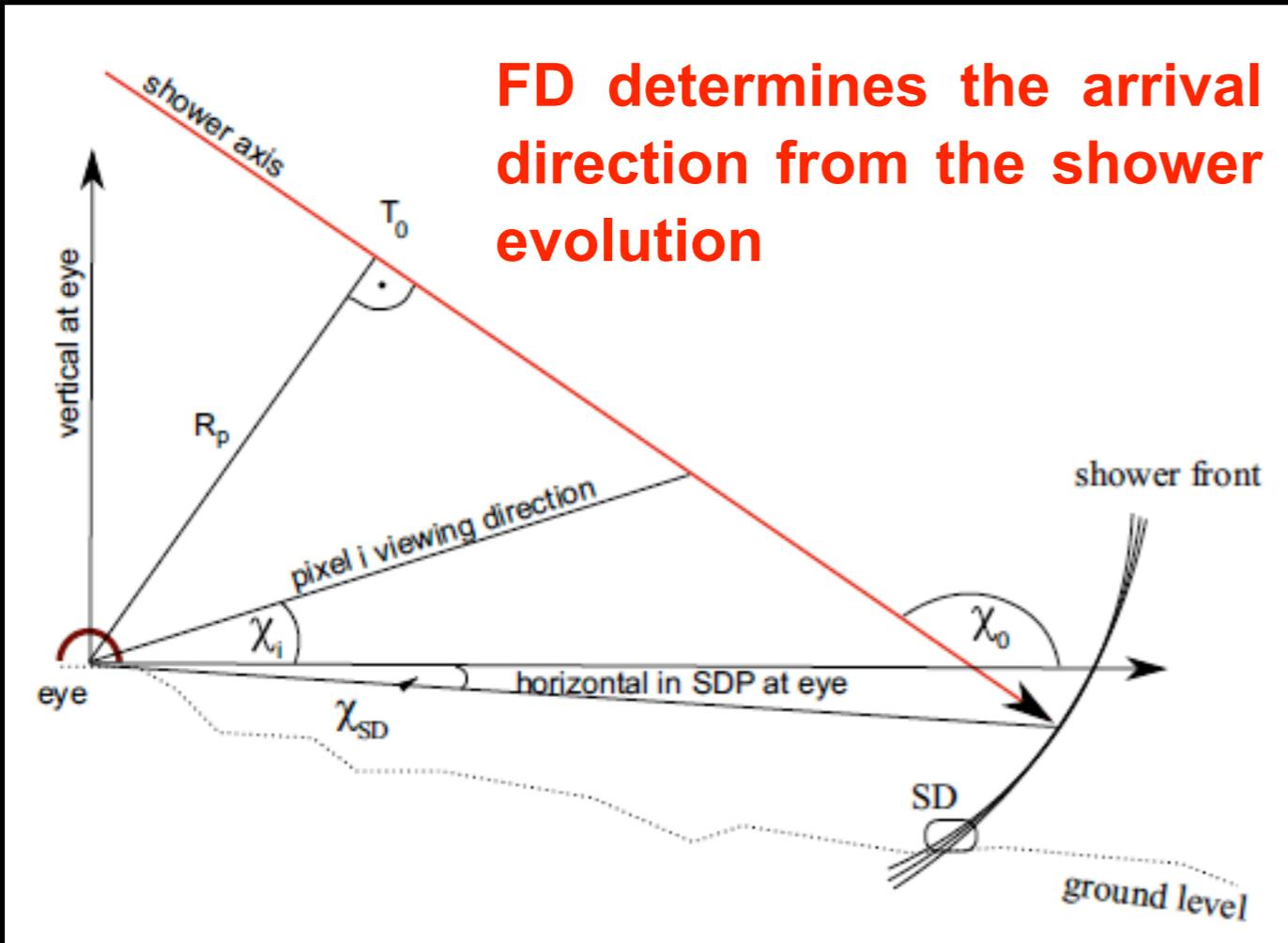

The arrival direction is obtained in two steps:

1. The observing directions of the triggered pixels and the detector itself define a plane that is called Shower Detector Plane (SDP).
2. The SDP contains the shower axis. The position of the shower axis within the SDP is obtained using the trigger times from the PMTs.

# Measurement of the arrival direction

*“Stereo” events, i.e., observed by two or more FDs*

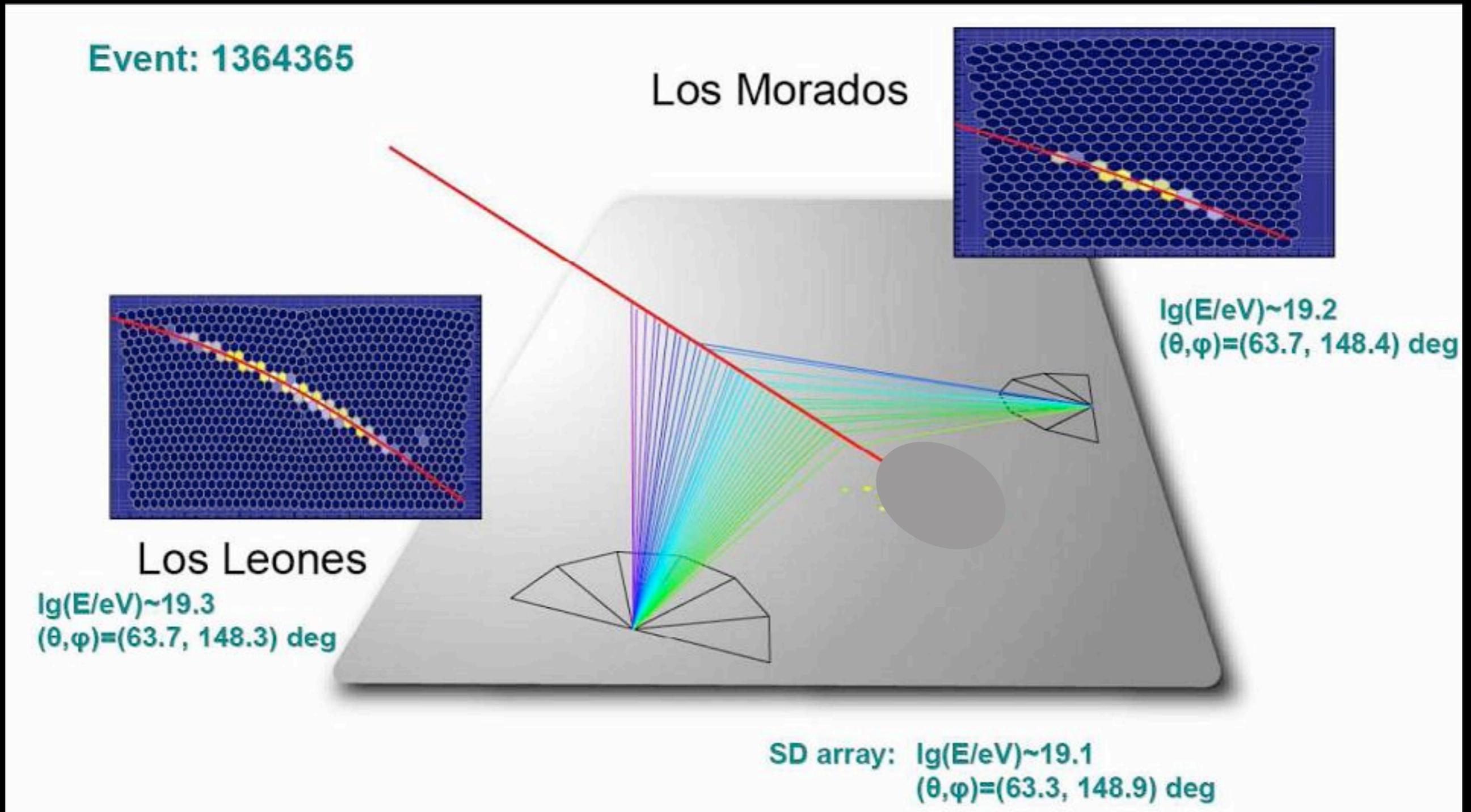

When an EAS is observed in “stereo”, the arrival direction is defined by the intersection of the two (or more) SDPs.

Higher precision, check of the geometry

# Measurement of the arrival direction

*“Hybrid” events, i.e., observed by SD and FD simultaneously*

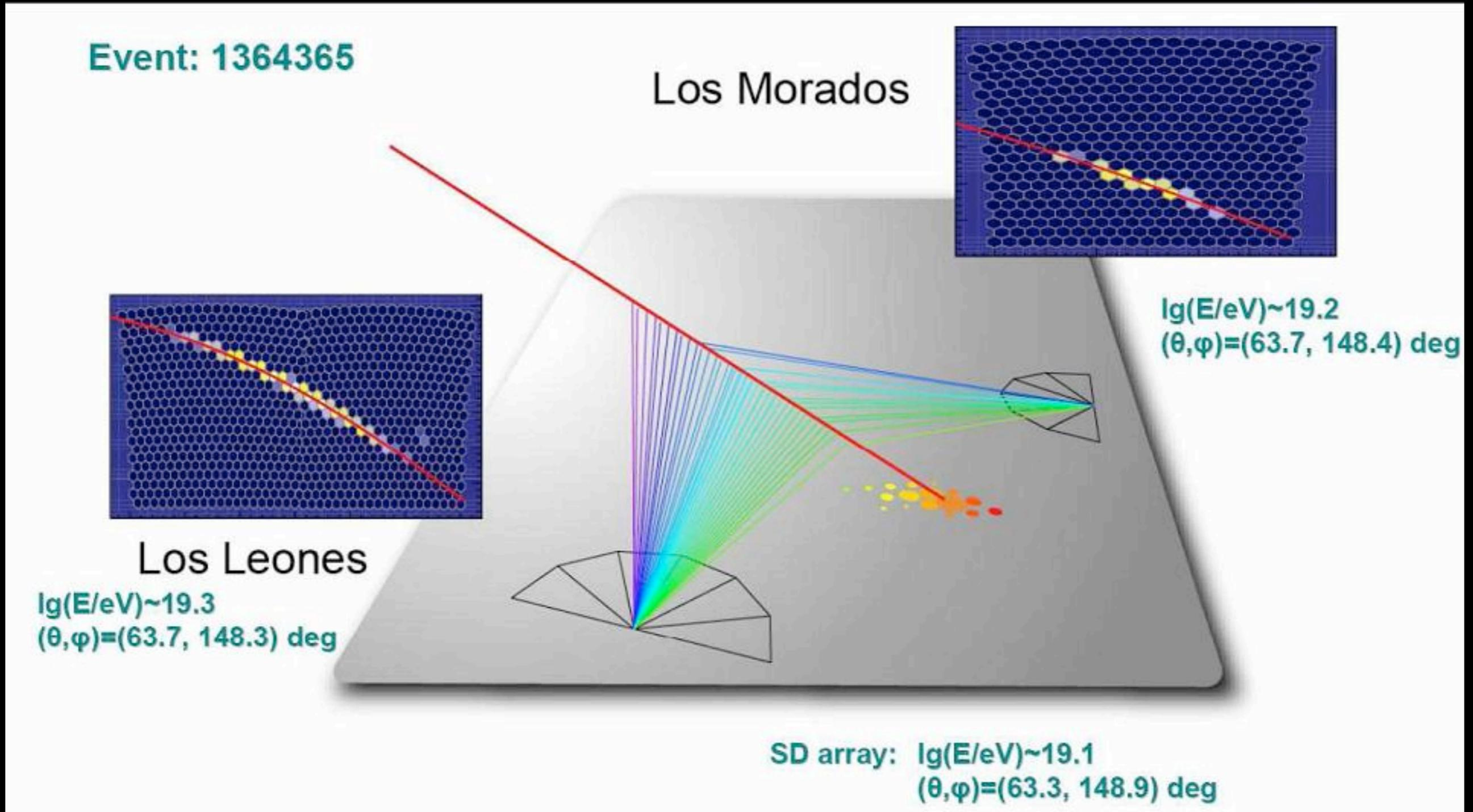

When an EAS is observed in “hybrid” mode, the geometry of the shower is fixed by SD (core position).

The angular resolution improves to  $\approx 0.5$  deg



# Arrival direction: a glance at the past

*Nani gigantum humeris insidentes: Bassi, Clark, Rossi (again!), (1953)*

The idea of constructing large-area detectors in which fast timing of the arrival of the shower particles would be possible is due to the MIT group, led by Rossi. They predicted that the shower directions could be determined within 2 degrees.

## Volcano Ranch (1960s)

where.<sup>1</sup> An array of scintillation detectors is used to find the direction (from pulse times) and size (from pulse amplitudes) of shower events which satisfy a triggering requirement. In the present case, the direction of the shower was nearly vertical (zenith angle  $10 \pm 5^\circ$ ). The values

## AGASA (1990s)

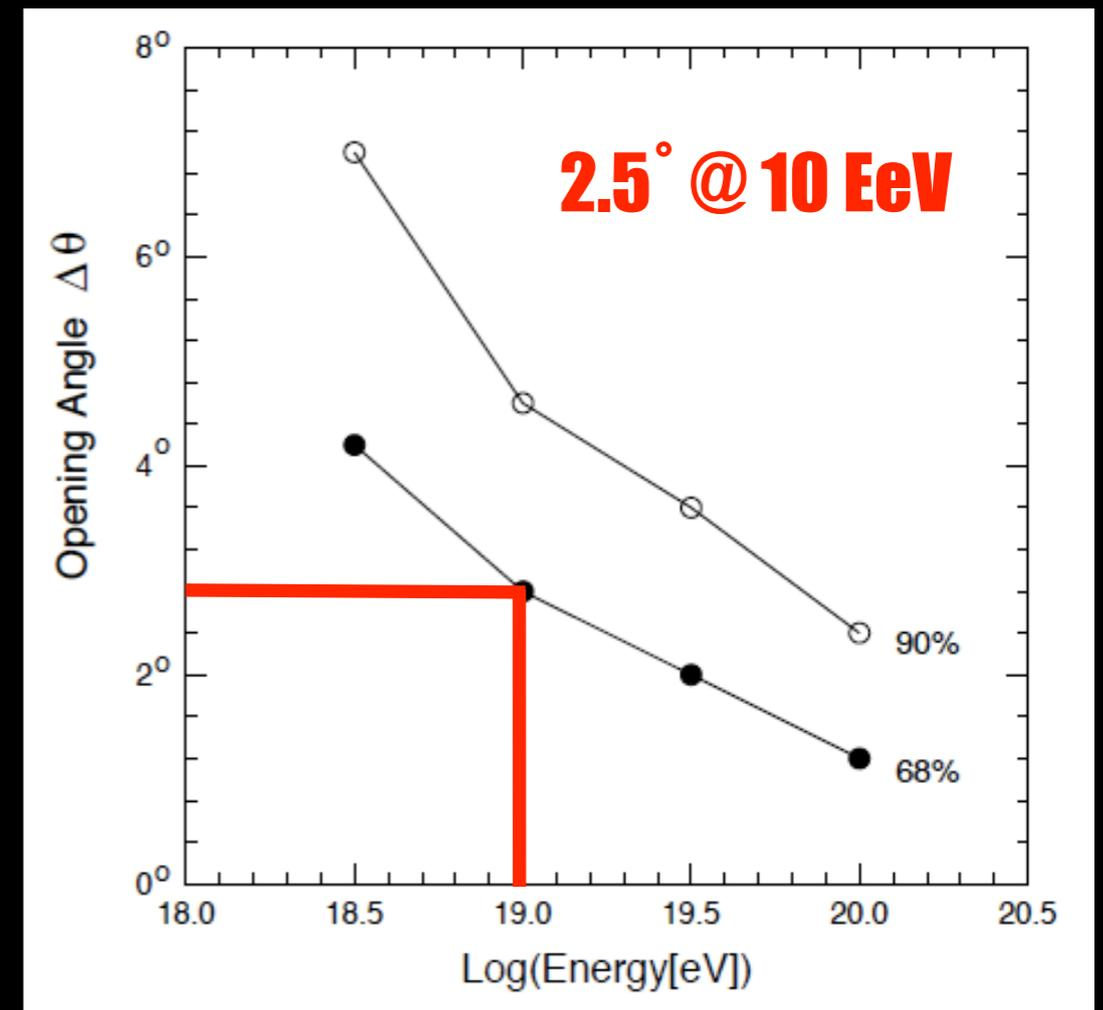

*Bassi et al were not so wrong after all!!!!*

# Slightly more difficult: energy

## Surface detectors

**SD measures a “slice” of the energy deposited from the shower: the best one can do is extracting from the “slice” an energy estimator**

### EARLY TIMES

- Showers contain nucleons, pions and muons in addition to the more abundant electrons and photons.
- Yet, well described under the assumption that the primaries were photons or electrons.
- Early practice: infer the primary energy from the total number of e.m. particles.
- Large uncertainty due to the lack of knowledge of the “true” LDF
- Large fluctuations

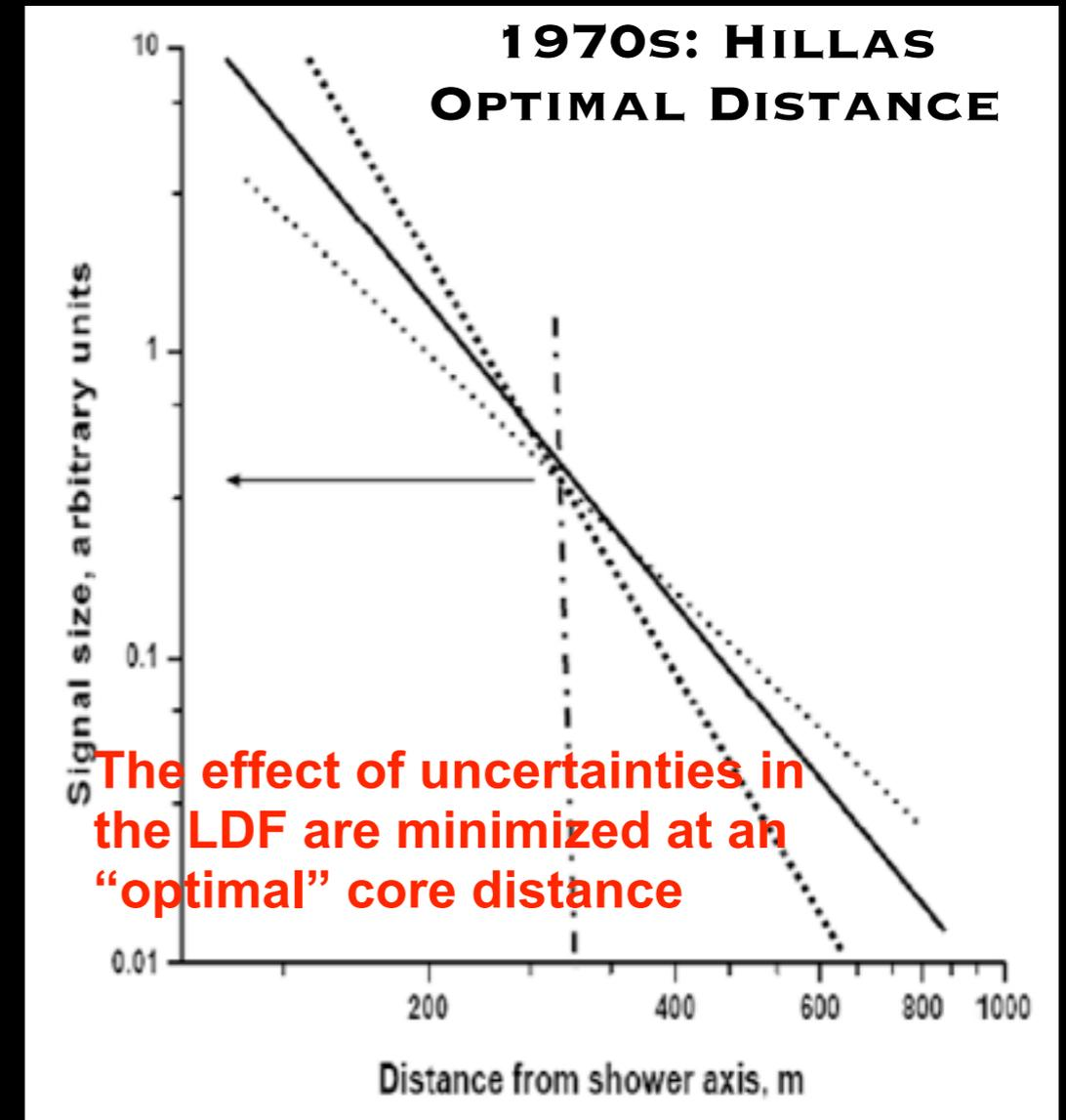

**Not only the signal at the “optimal” distance minimally depends on the chosen LDF, but also the fluctuations of the particle density far from the core are quite small.**

# Energy estimator from the surface detectors

*In practice*

**AUGER**

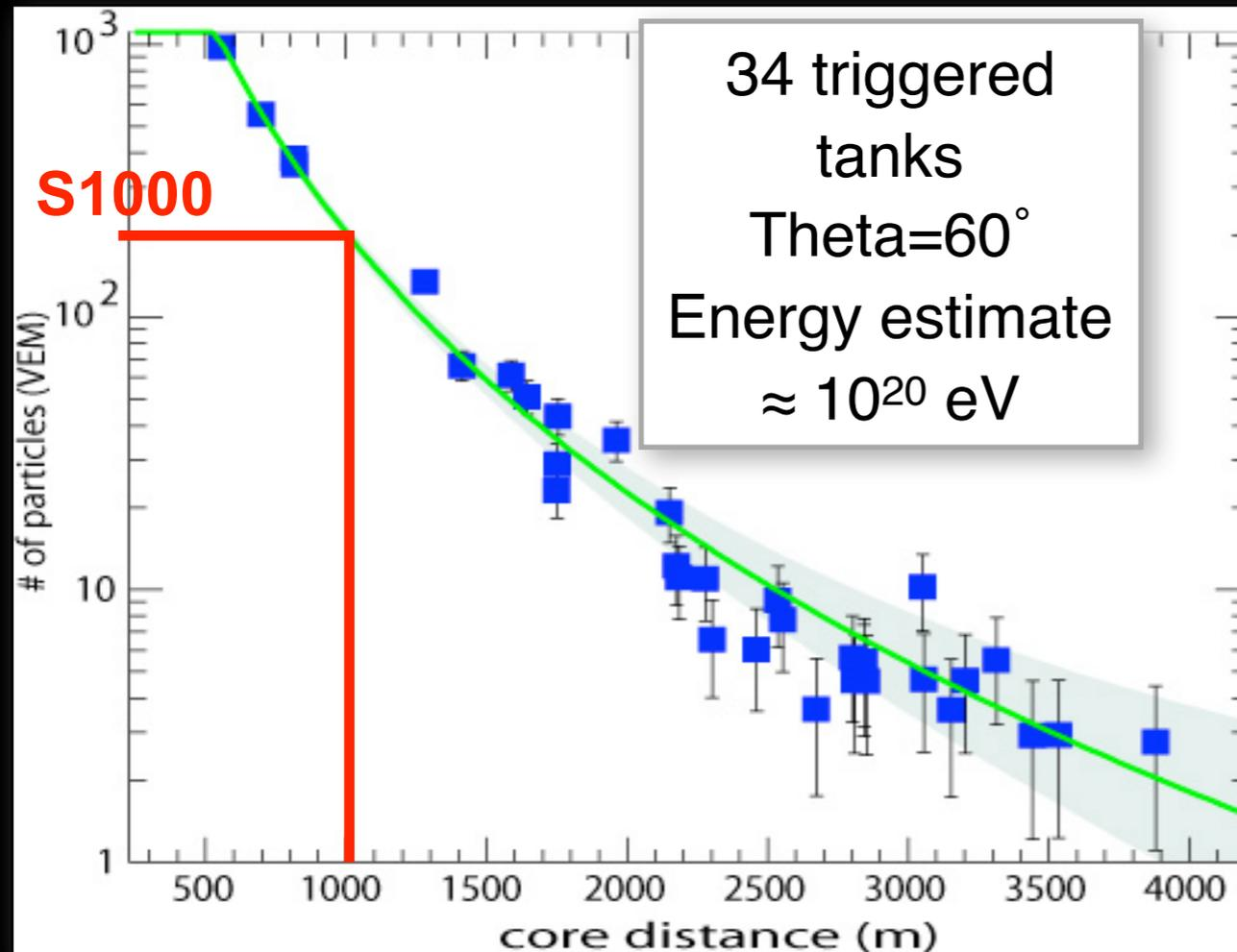

**TELESCOPE ARRAY**

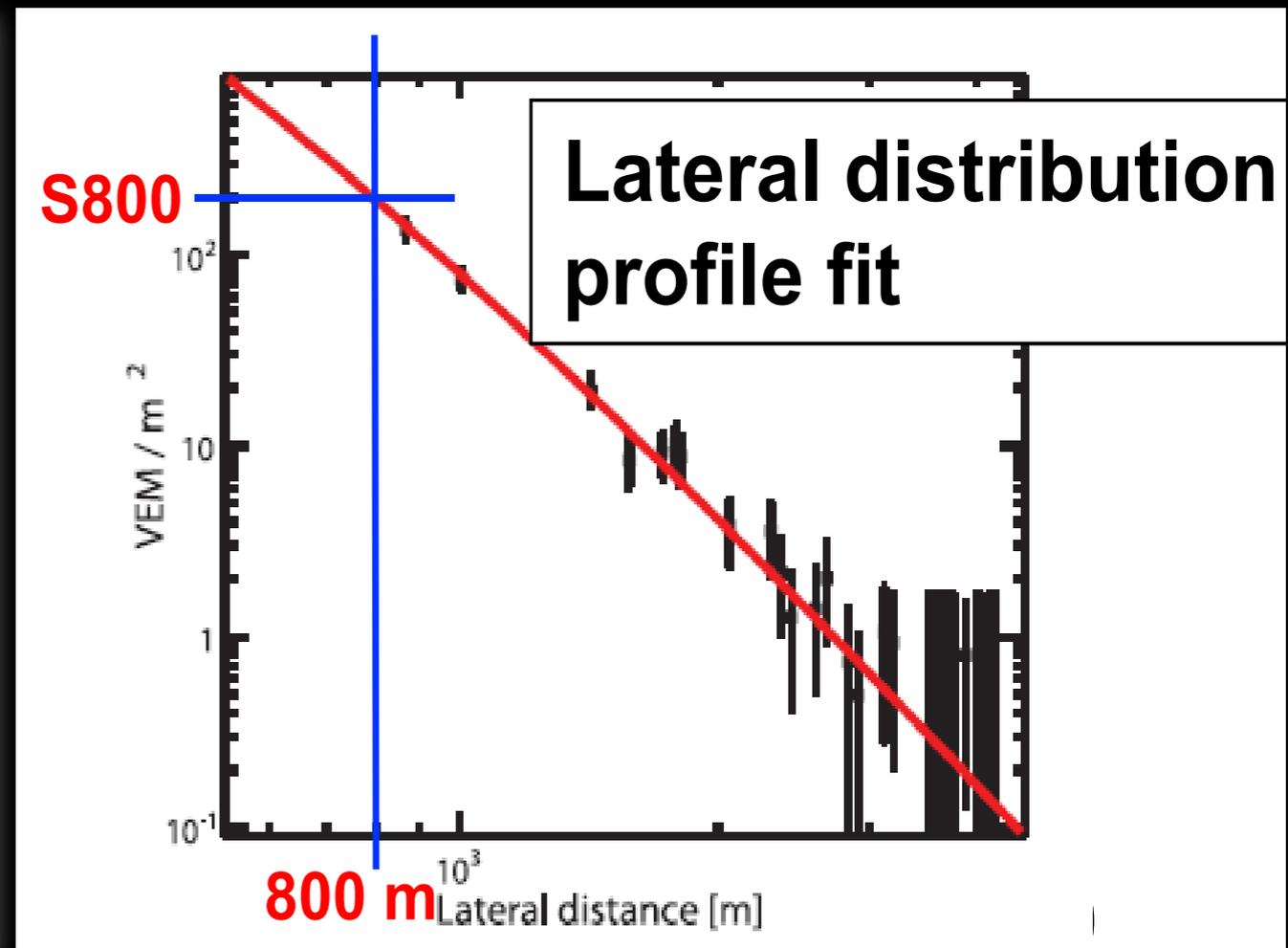

- ✦ Reconstruct geometry (arrival direction & impact point)
- ✦ Fit particle lateral distribution (LDF)
- ✦ **Extract the signal at the “optimal” distance**
- ✦ The “optimal” distance depends on detectors spacing,  
 $r_{\text{opt}}=1000/800$  m for Auger/TA)

# How to pass from energy estimator to primary energy?

Usually full Monte Carlo simulations are used

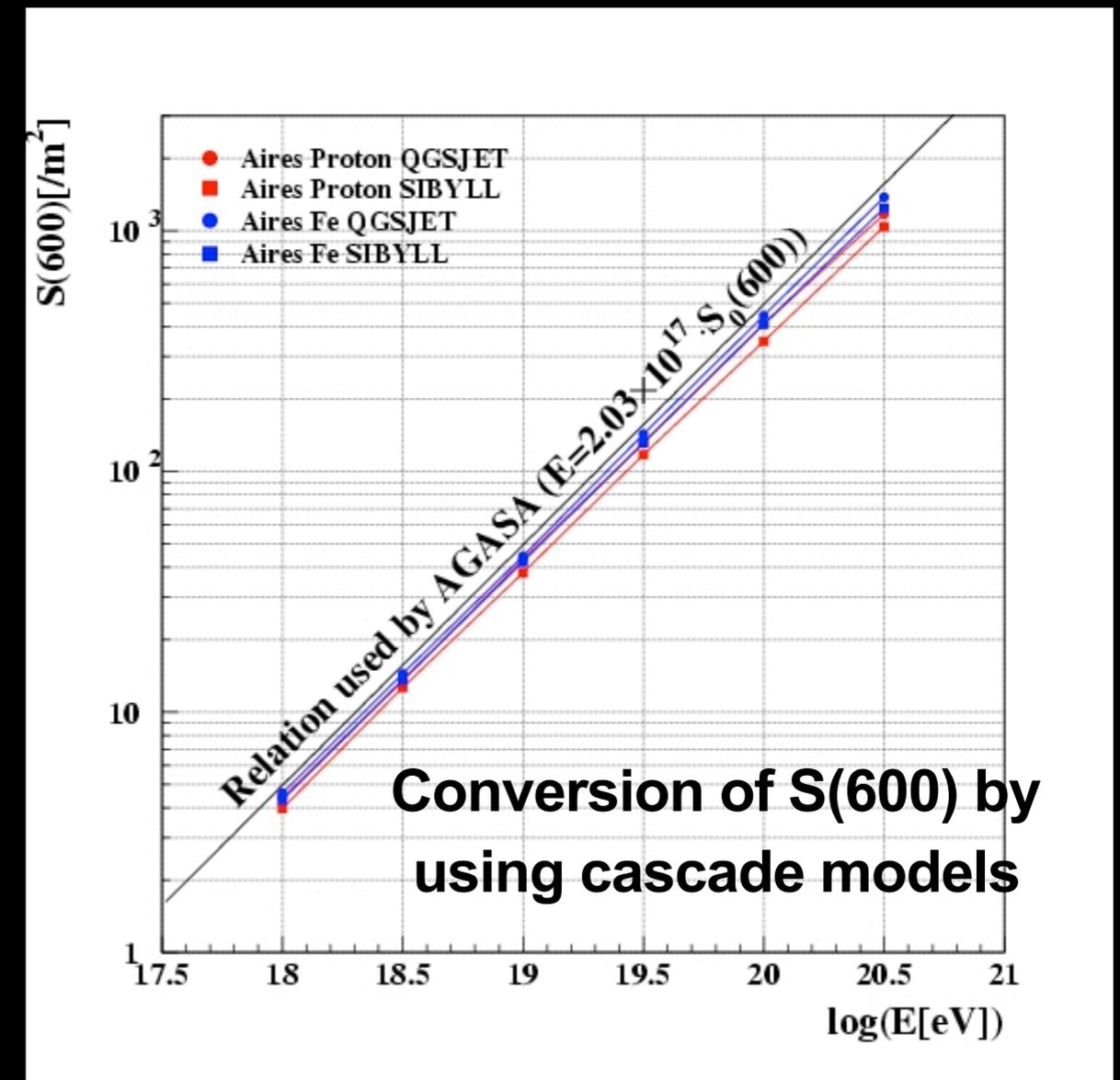
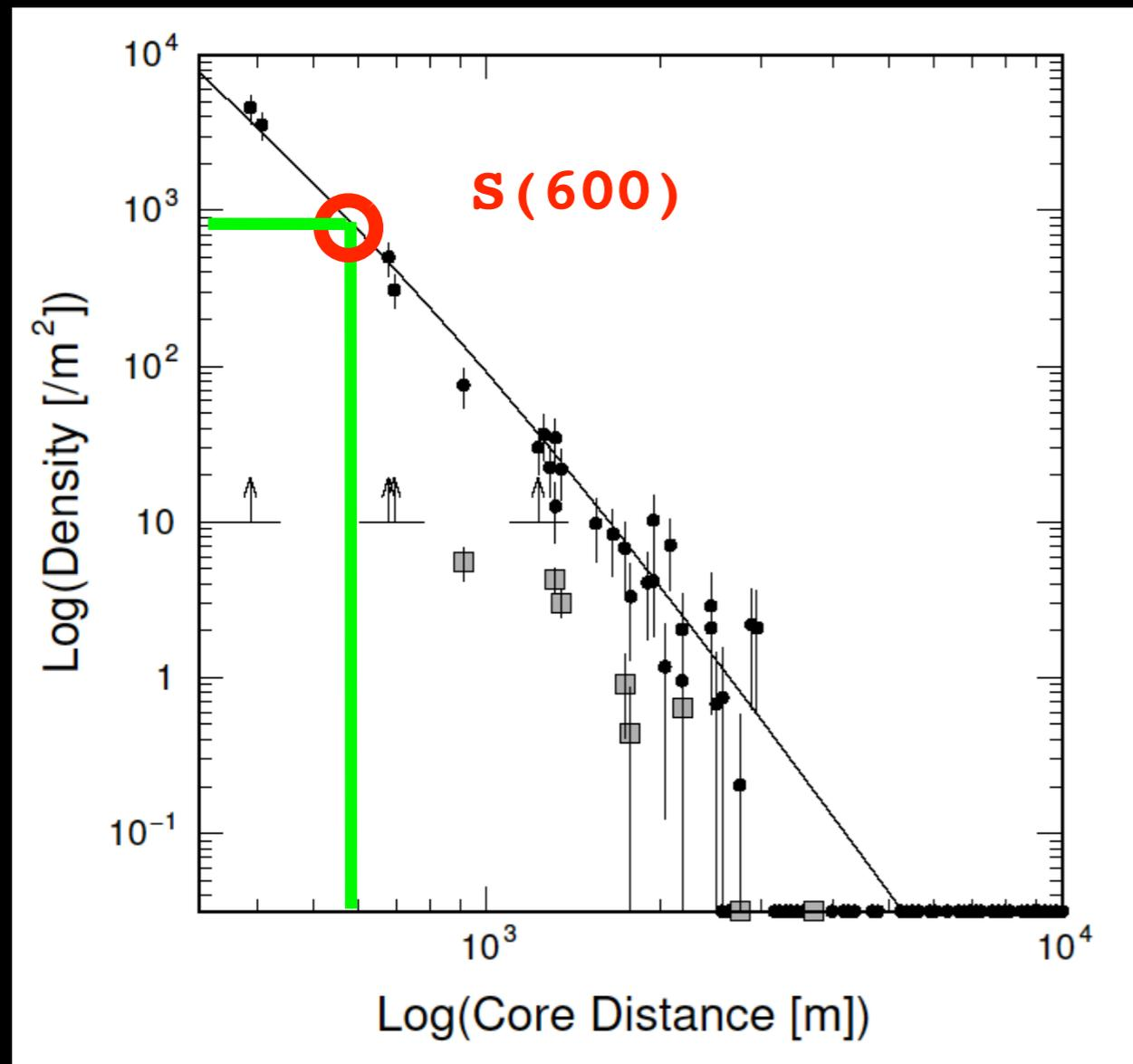

To determine the primary energy from measurements with a surface array one one has to use predictions from calculations of shower development

**MEMENTO: UHECR energies are well-above those produced in accelerators!!!**

Model predictions draw on extrapolations of the properties of interactions studied at accelerators. Large (if not unknown) systematics

# The smartness of the hybrid technique

*Use fluorescence detectors to calibrate surface detectors*

**The UHECR energy is deposited in atmosphere like in a giant calorimeter. Fluorescence detectors see the full development**

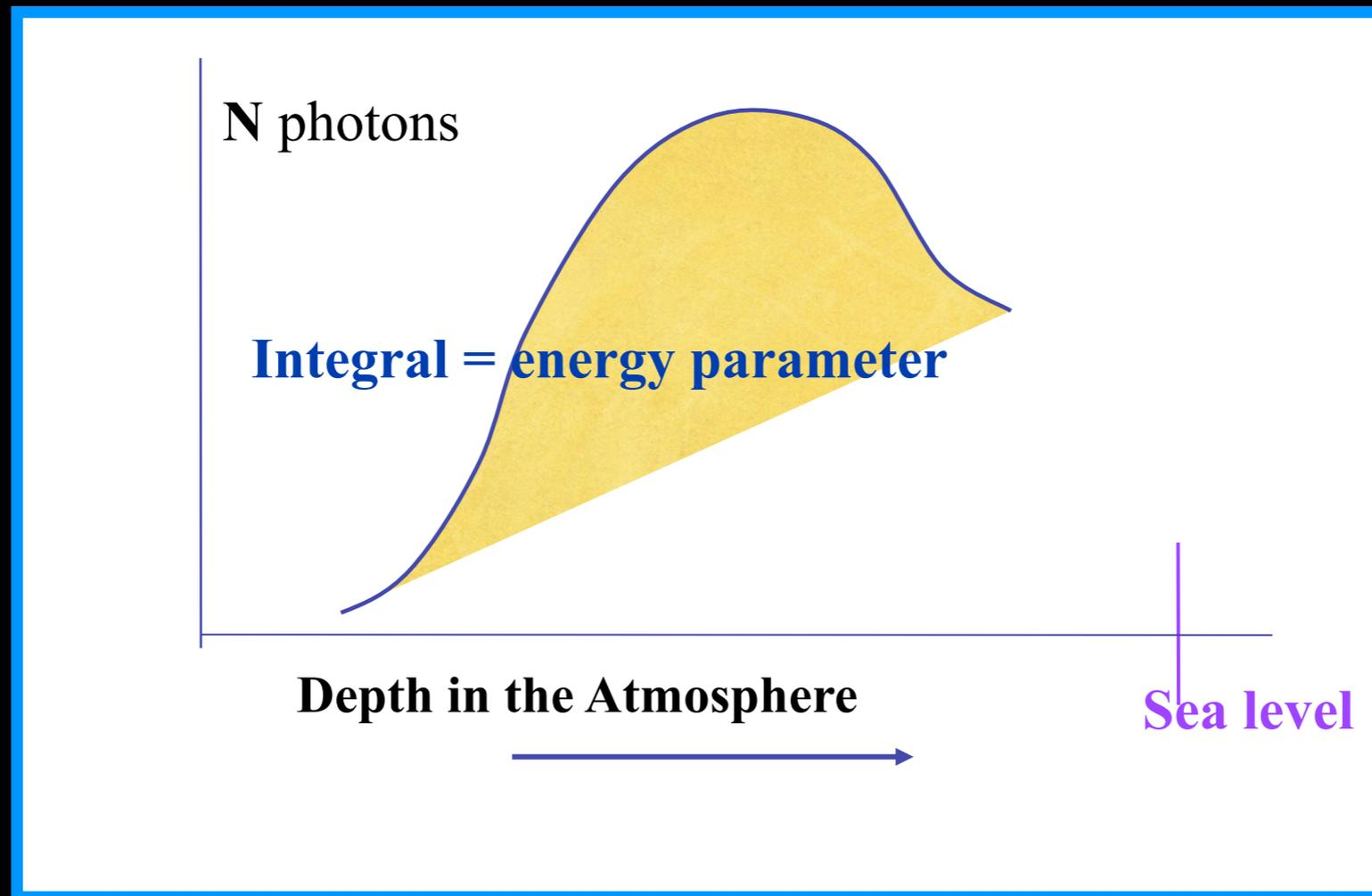

**Fluorescence detectors allow for a direct measurement of the shower energy deposited in atmosphere.**

**Model predictions do not enter the game!**

# UHECR energy from fluorescence detectors

## *In practice*

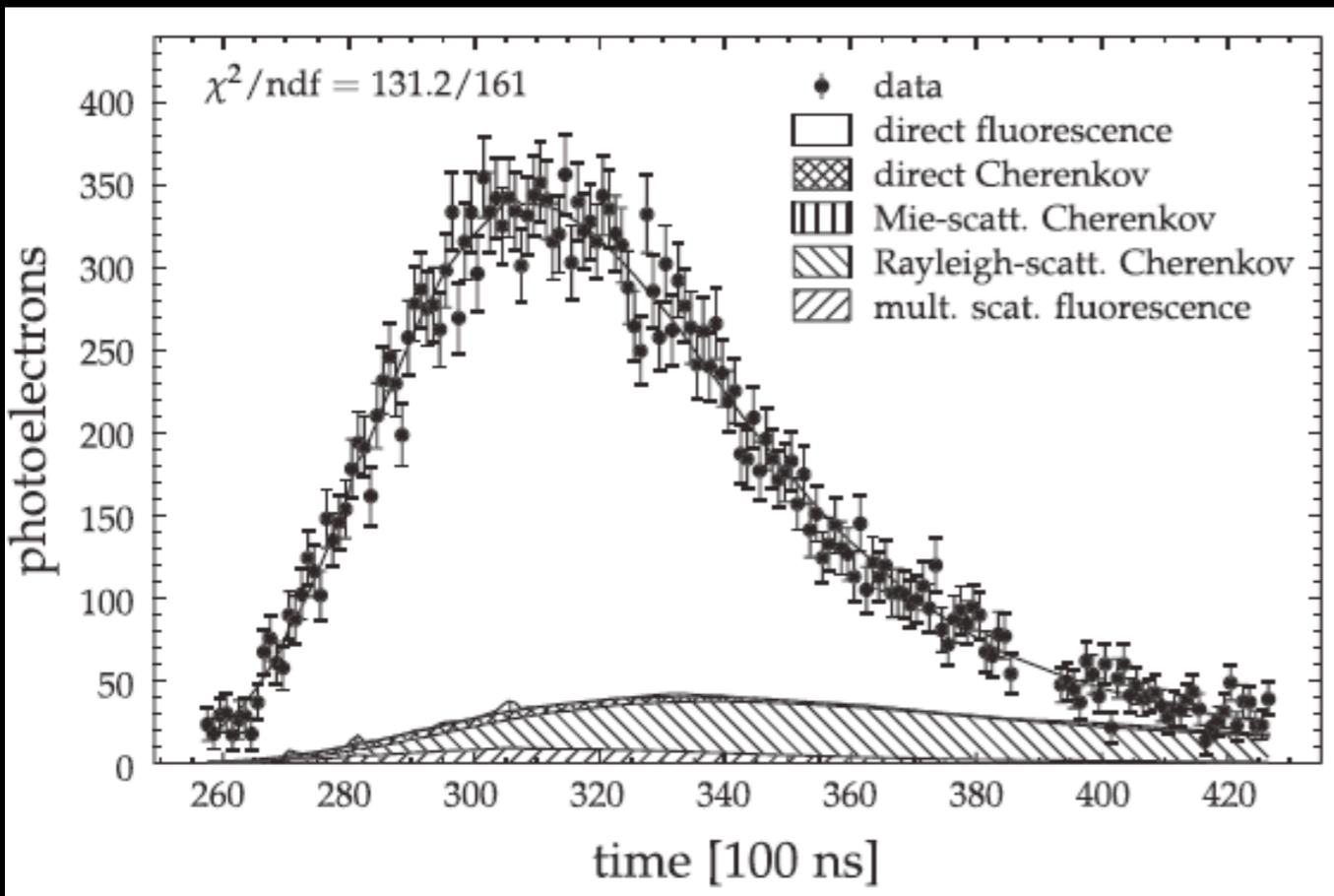

*Photons vs time*

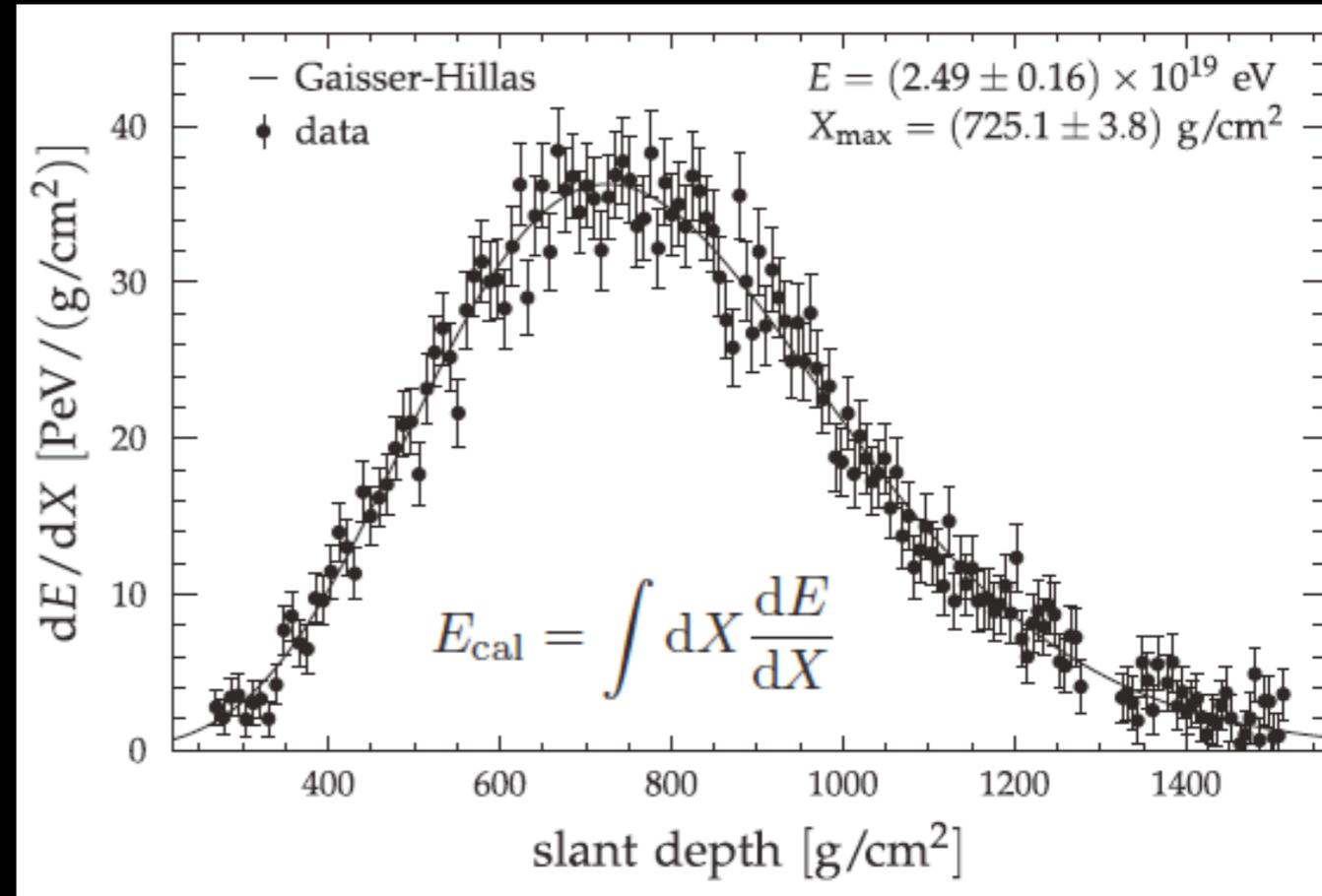

*Energy deposit vs slant depth*

- ✦ Reconstruct geometry (shower detector plane - SDP - and shower axis in SDP)
- ✦ Fit longitudinal shower profile: a log-likelihood fit of the number of photons detected in the PMTs using the Gaisser-Hillas function
- ✦ The number of detected photons is folded with the **fluorescence yield**, and the **atmospheric transmission**
- ✦ The energy is derived after correcting for the **“invisible” energy**, carried away by neutrinos and muons.

# The smartness of the hybrid technique

Use hybrid events for the calibration of the SD energy estimator with the FD calorimetric energy

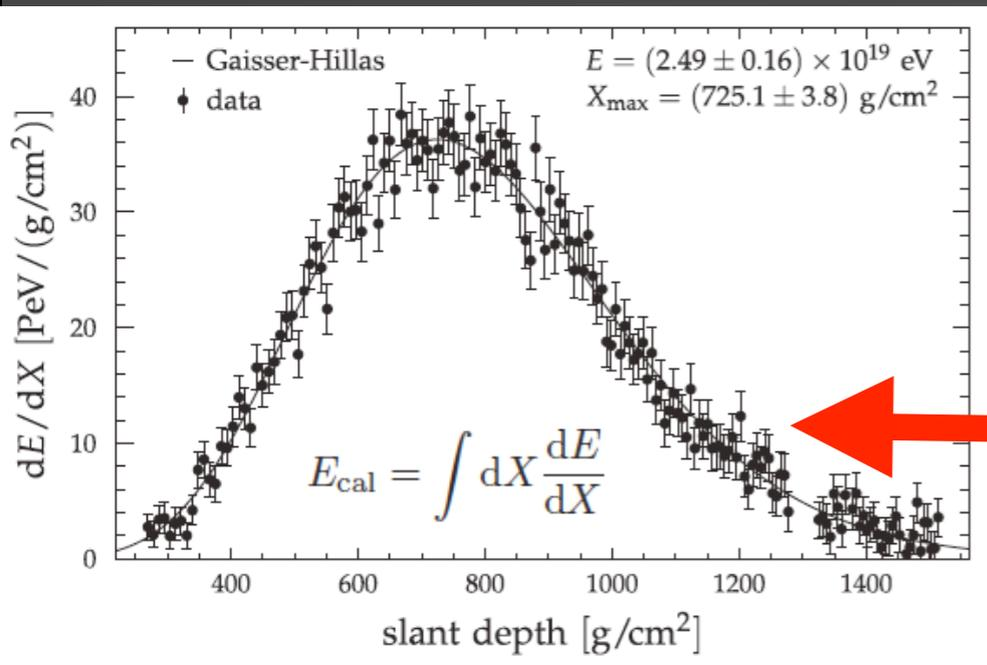

**LONGITUDINAL PROFILE  
RECONSTRUCTION: FD**

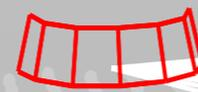

Signal

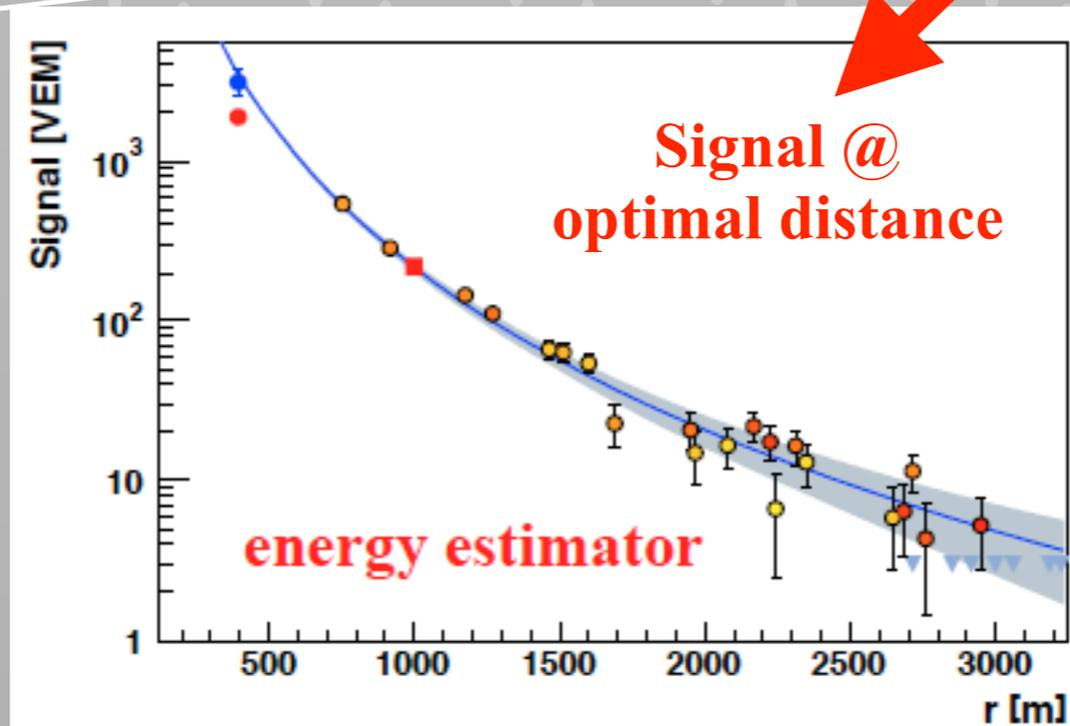
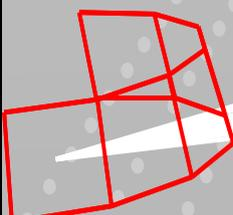
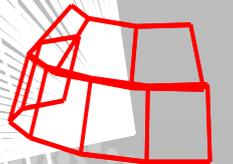

**PARTICLE LATERAL DISTRIBUTION: SD**

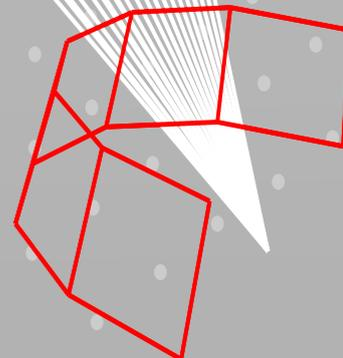

# The smartness of the hybrid technique

*In practice*

AUGER

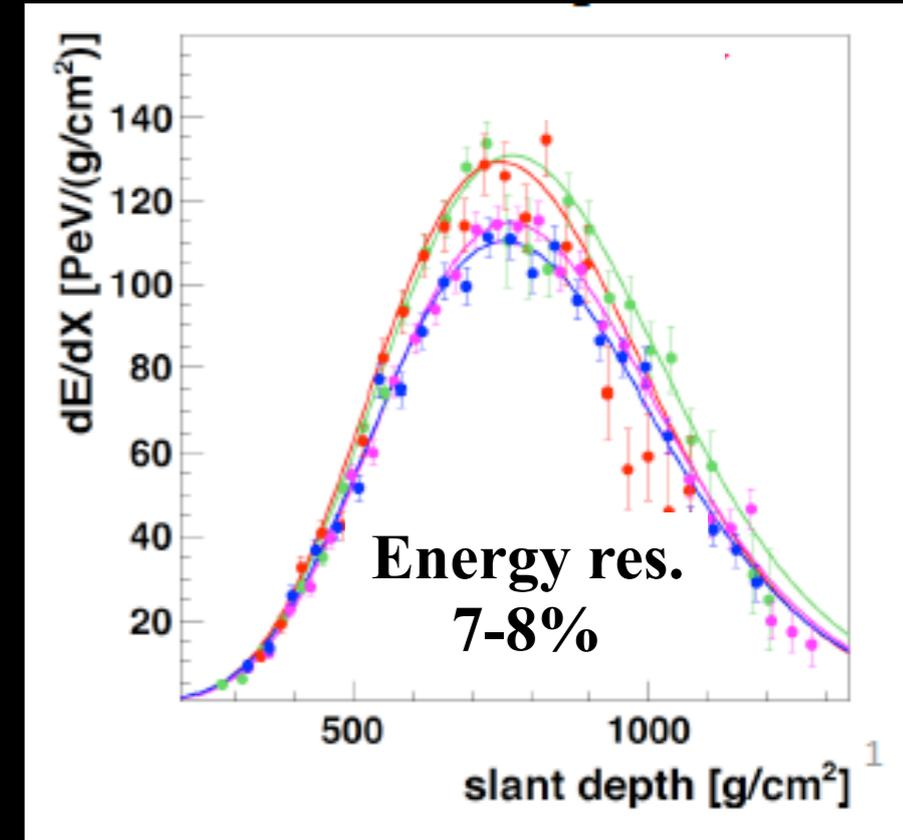
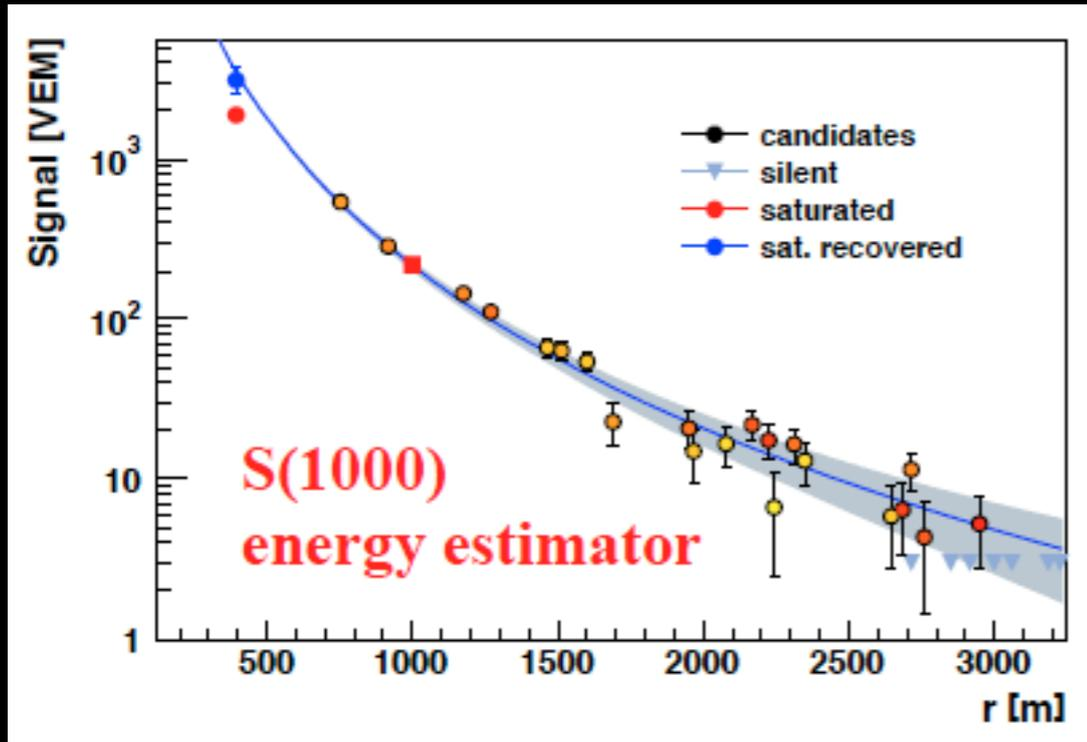

HYBRID EVENTS:  
CALIBRATION OF  
SD ENERGY  
ESTIMATOR WITH  
FD CALORIMETRIC  
ENERGY

TELESCOPE ARRAY

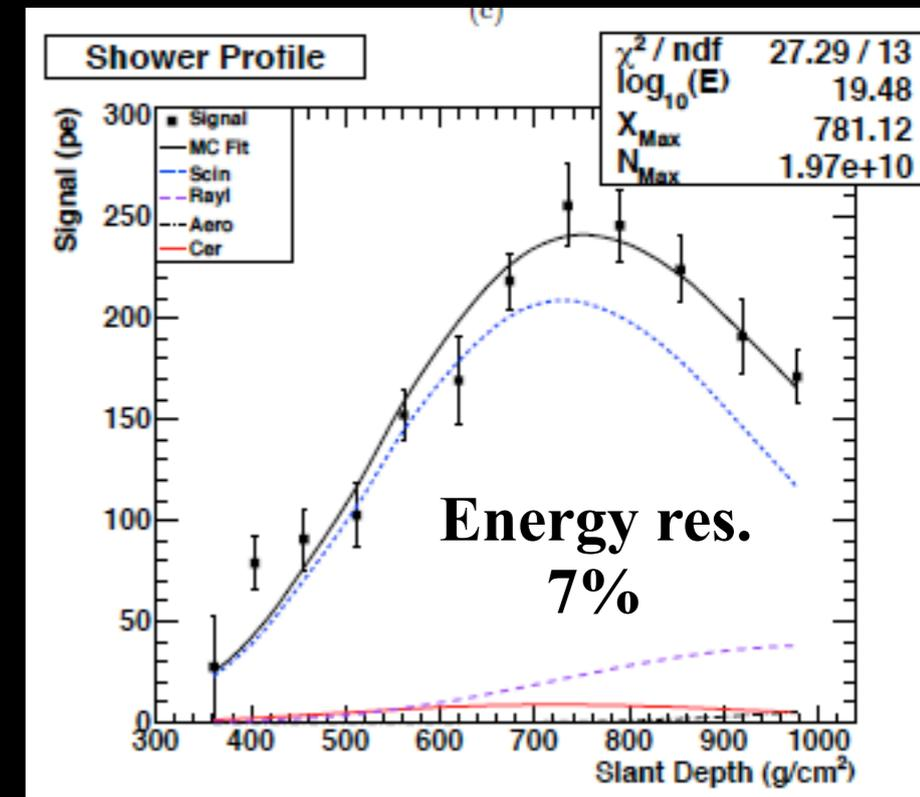
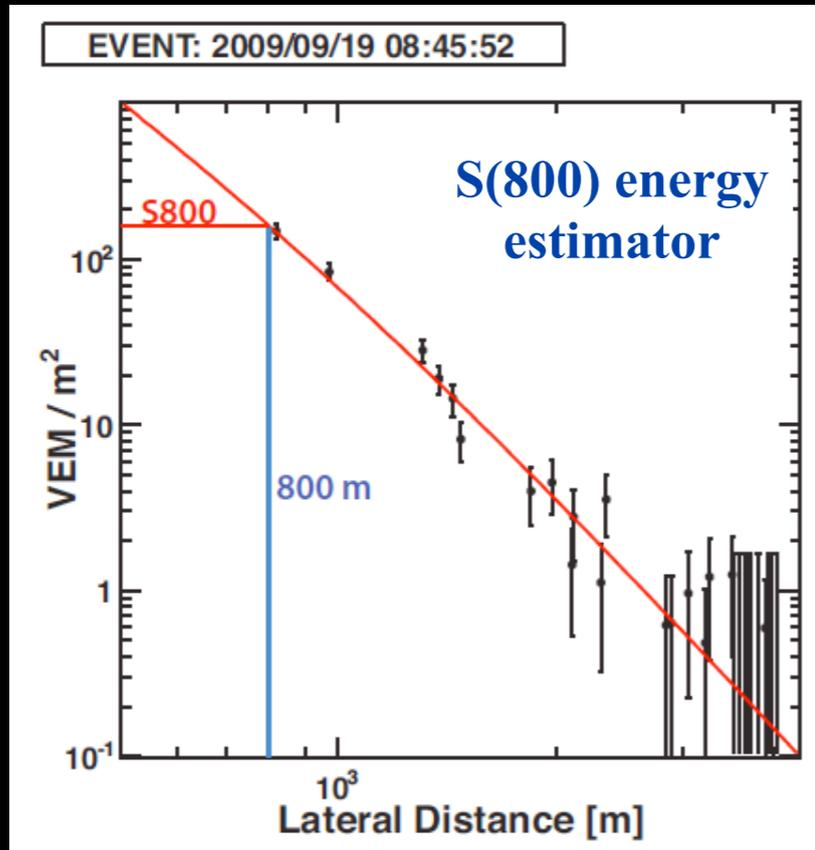



# Energy calibration

*In practice*

**AUGER**

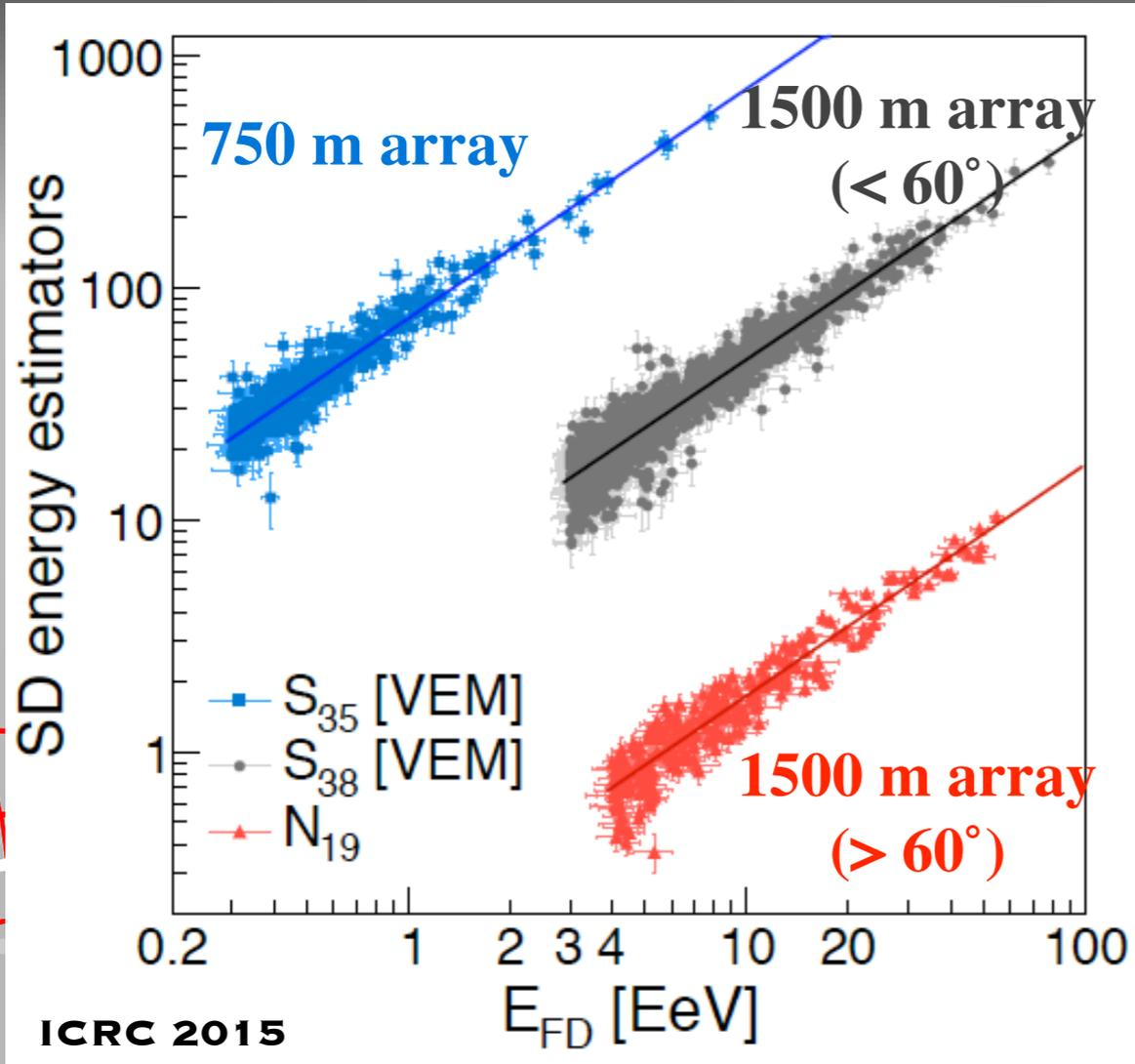

**TELESCOPE ARRAY**

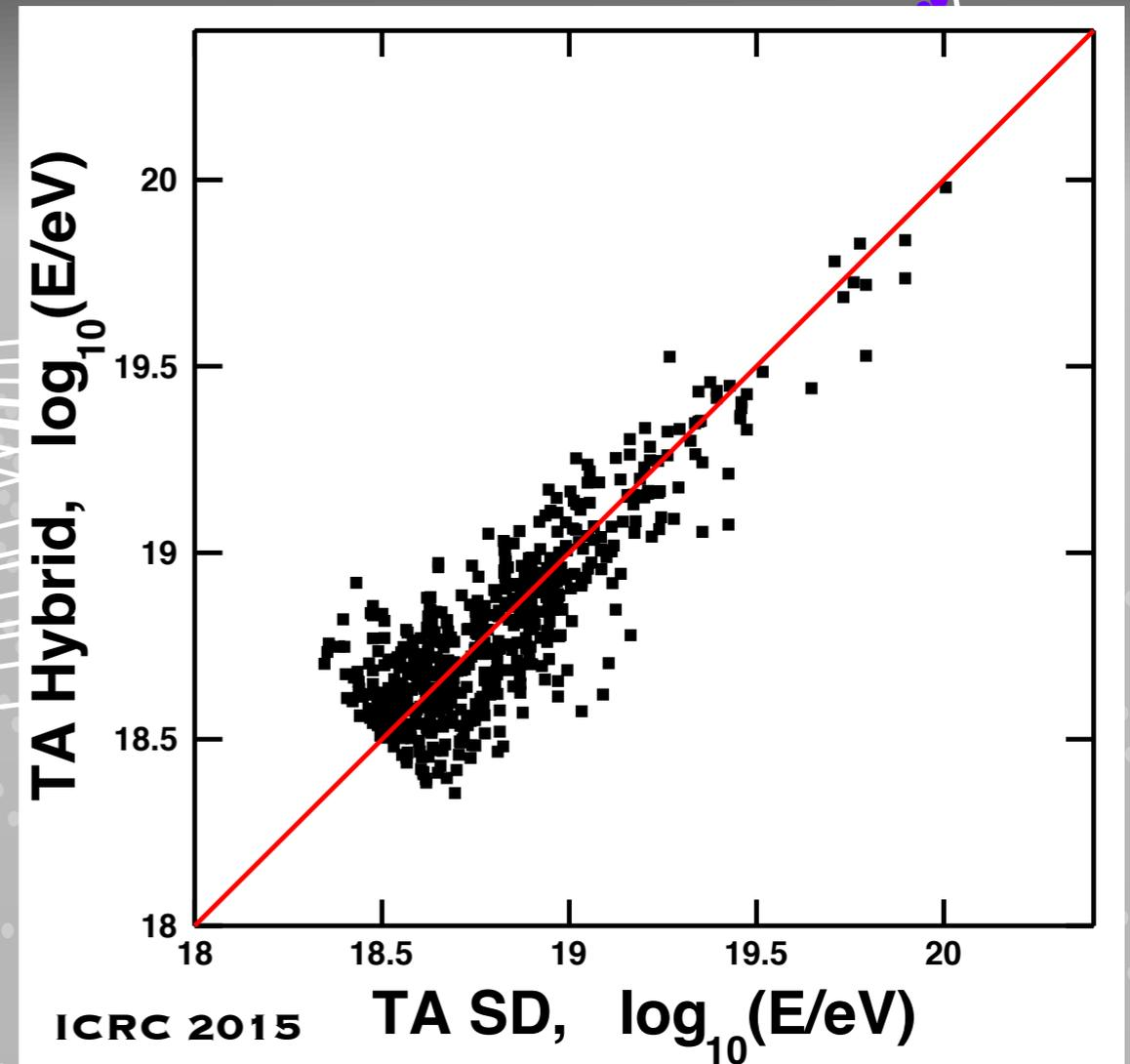

- Purely data-driven calibration
- $S(1000)$  is corrected for attenuation/theta (Constant Intensity Cut)  $\rightarrow S_{38}$
- $S_{38}$  is calibrated versus EFD

- $S(800)$  is converted to energy  $E(S800, \theta)$  through a MC look-up table
- The model dependence is removed via the calibration with EFD

# Energy resolution

## AUGER

### Systematic uncertainties on the energy scale

Fluorescence yield	3,6 %
Atmosphere	3.4%-6.2%
FD calibration	9,9 %
FD reconstruction	6.5%-5.6%
Invisible energy	3%-1.5%
Stat. error of the cal. fit	0.7%-1.8%
Stability of the E scale	5 %
<b>TOTAL</b>	<b>14 %</b>

**SD ENERGY STATISTICAL  
UNCERTAINTY (@10 EEV)  $\approx$  12%**

## TELESCOPE ARRAY

### Systematic uncertainty in energy determination

Fluorescence yeild	11%
Atmospheric attenuation	11%
Absolute detector calib.	10%
reconstruction	10%
<b>total</b>	<b>21%</b>

**SD ENERGY STATISTICAL  
UNCERTAINTY (@10 EEV)  $\approx$  20%**

# The most difficult one: mass

The mass of an UHECR can only be inferred from comparisons of observables with shower simulations, subject to uncertainties of models of hadronic interactions at energies not accessible to accelerators

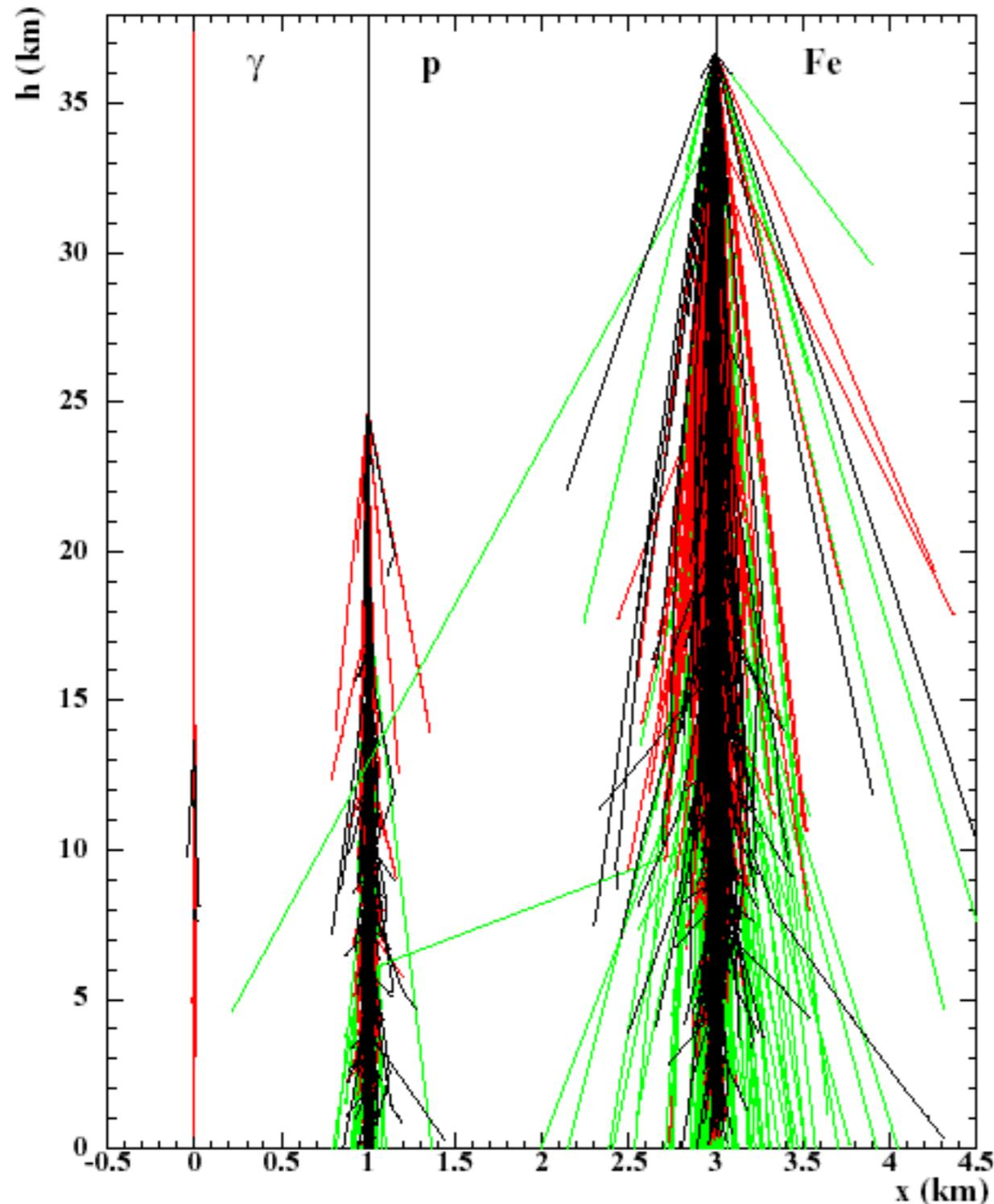

Observables sensitive to composition:

- Depth of shower maximum (at fixed energy, a nucleus-shower develops faster than a proton-shower)
- Relative number of electrons and muons (primary nucleus produces more muons than a primary proton)
- Shower front curvature (the higher the first interaction, the flatter the front)

# The most difficult one: mass

**Xmax, the depth of the shower maximum, is the main EAS observable sensitive to CR mass**

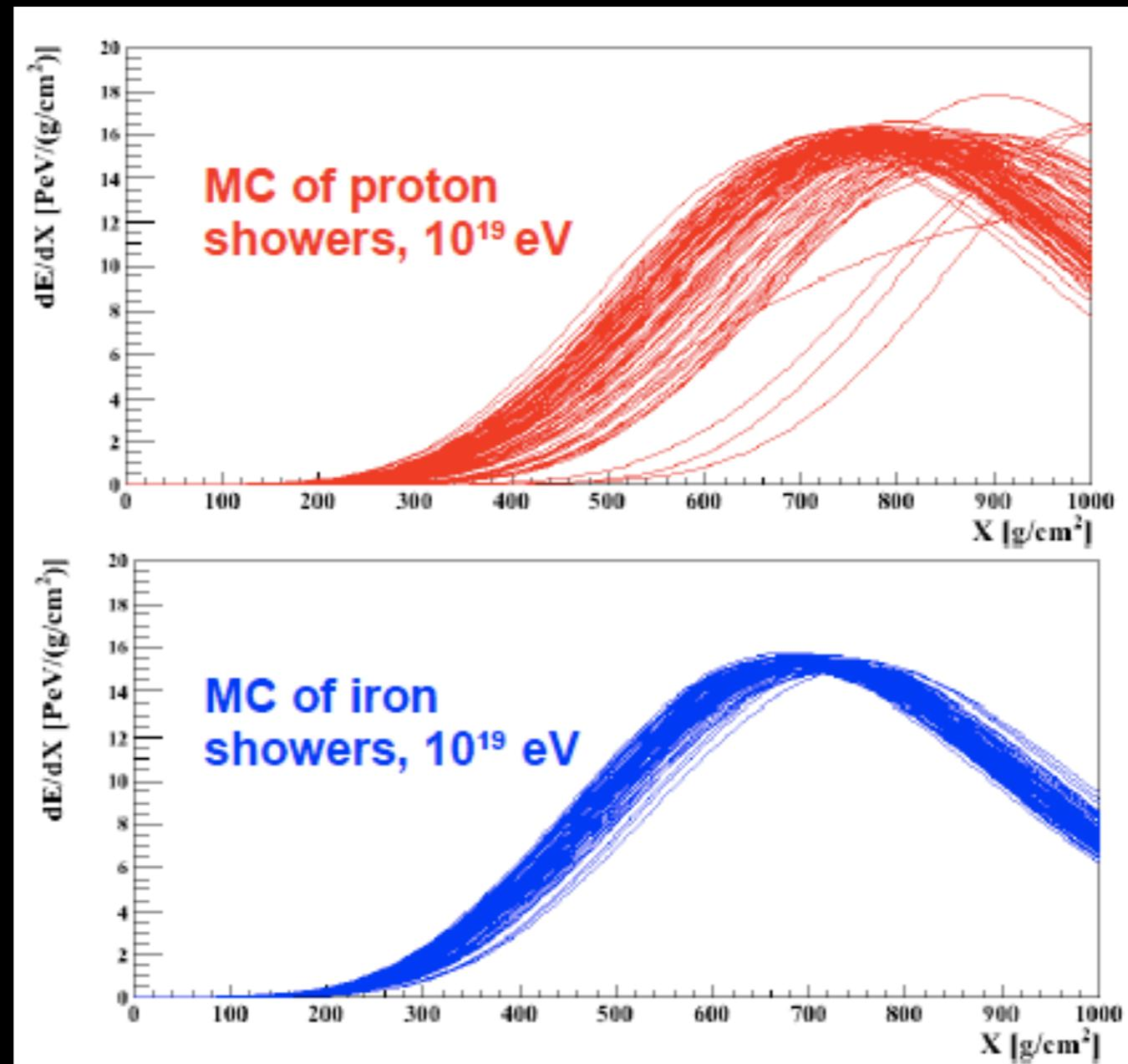

**First interaction of heavier primaries is shallower and fluctuates less.  
Sigma of the Xmax distribution is mass sensitive too**

# Xmax measurement

*In practice*

Xmax can be directly measured by fluorescence detectors

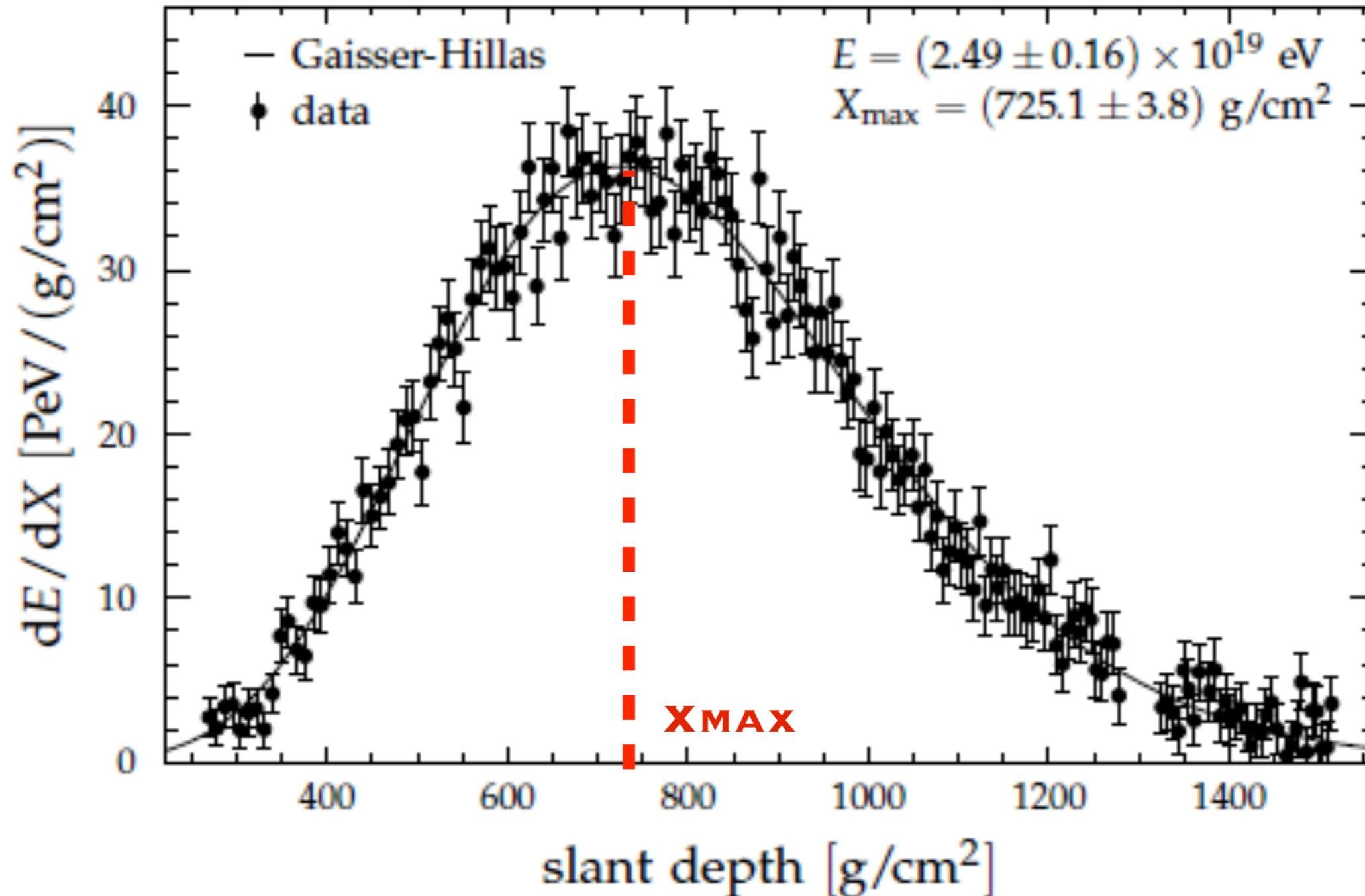

# Xmax resolution

## AUGER

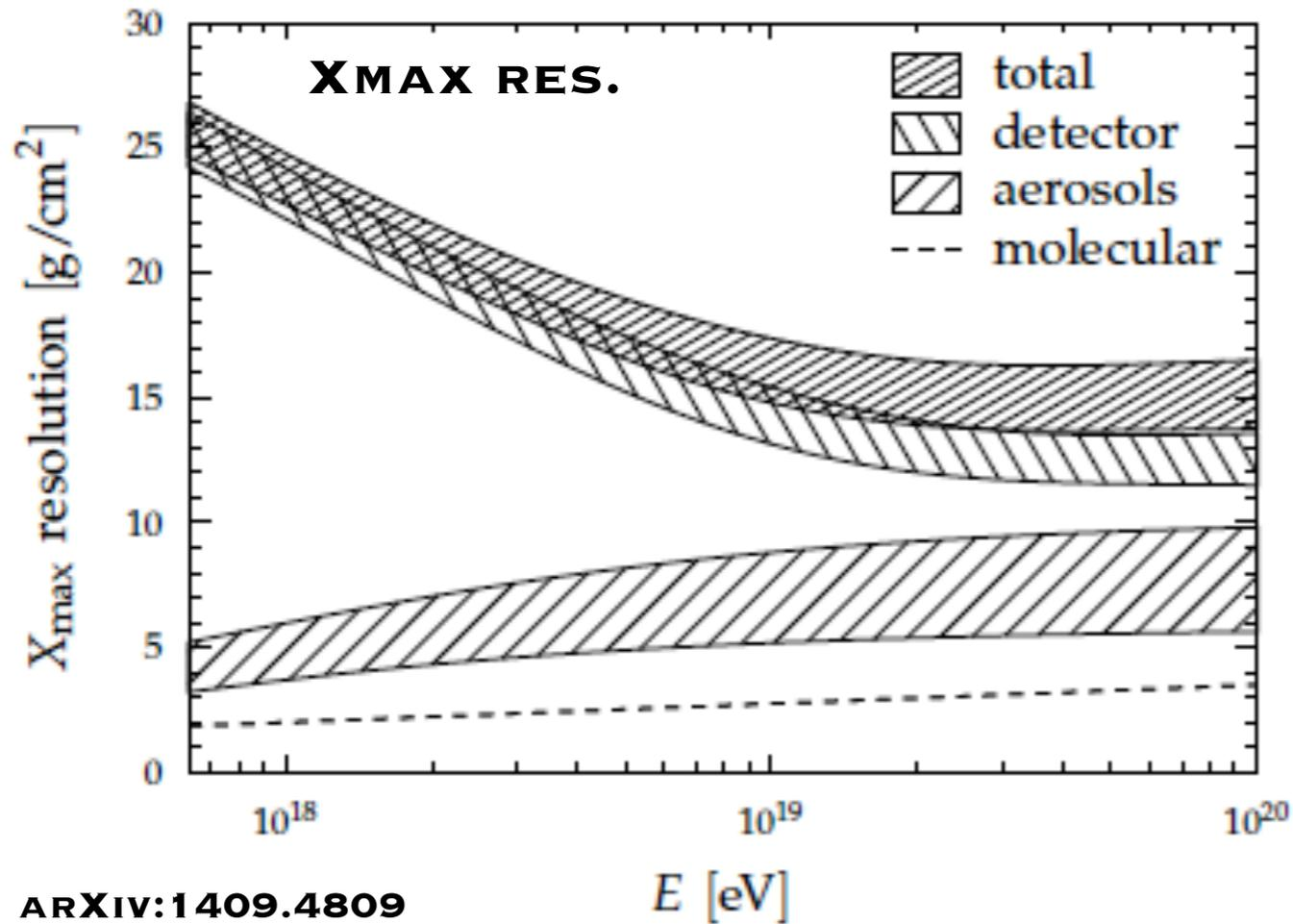

## TELESCOPE ARRAY

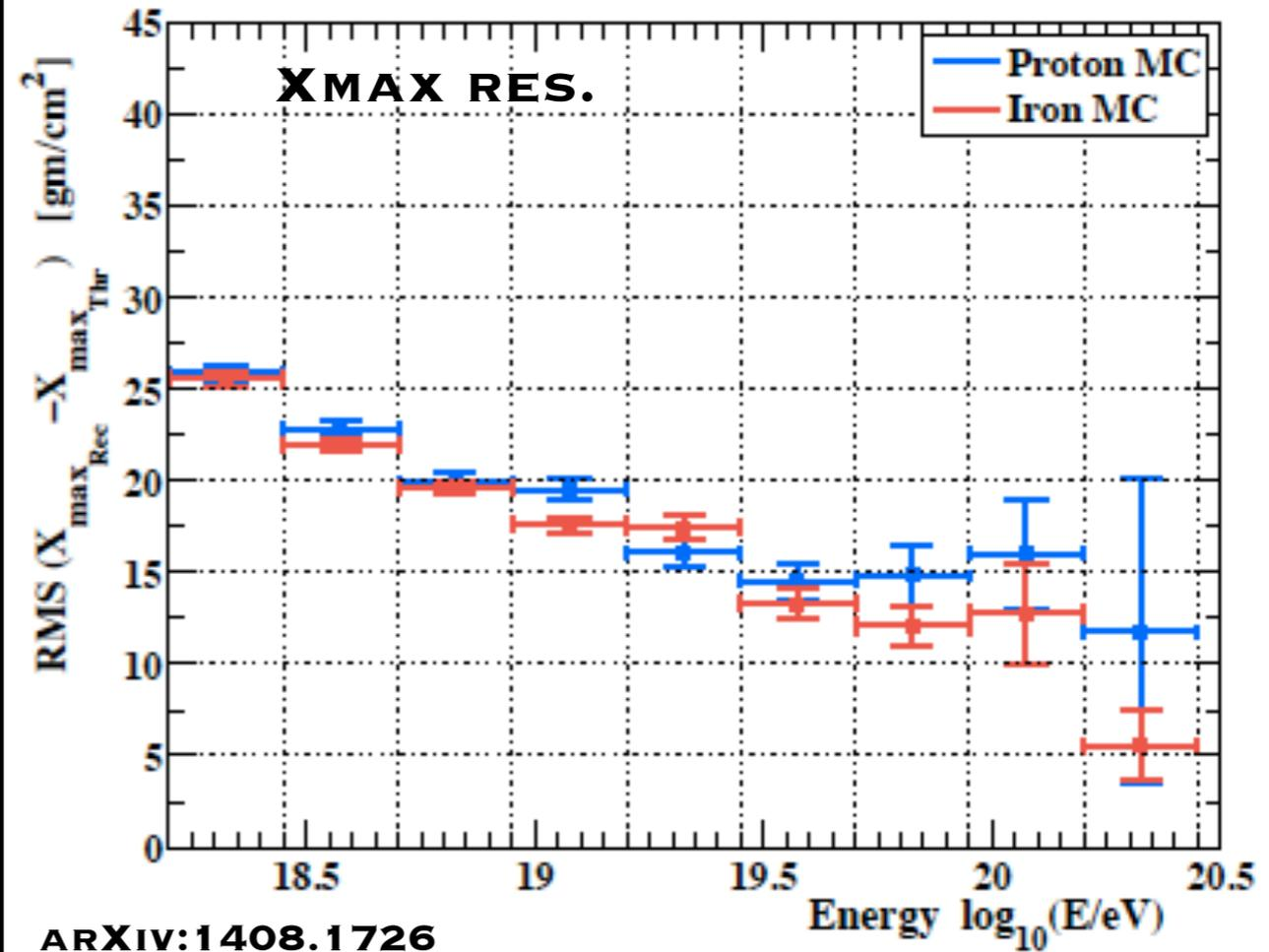

Between 25 and 15  $\text{g}/\text{cm}^2$ , getting better with increasing energy

SYSTEMATIC UNCERTAINTY  $\approx 10\%$

SYSTEMATIC UNCERTAINTY  $\approx 16\%$

# Finally ready to go to UHECR inferences!

## ONCE WE KNOW...

**Energy**

**UHECR mass**

**UHECR arrival direction**

## WE CAN STUDY...

**Flux vs energy**  
**[Energy spectrum]**

**Origin of spectral feature(s)**

**Distribution of arrival**  
**directions**

***It's time to pass the torch to Michael Unger...***

# Credits

It is hard to keep track of the original source of material contained in a lecture. My apologies to those who originally created the plots and graphs collected here and are not properly quoted.

Innumerable papers have served to this lecture, more or less modern.

It has been a pleasure to take profit of a few historical books which made me feel humble:

Bruno Rossi, *Cosmic Rays*, Mc Graw-Hill 1964

Michael W. Friedlander, *Cosmic Rays*, Harvard University Press 1989

Yataro Sekido and Harry Elliot, *Early History of Cosmic Ray Studies*, Reidel Publishing Company 1985

Malcolm S. Longair, *High Energy Astrophysics*, Cambridge University Press

And finally I am in debt with countless colleagues with whom I share the passion for Extensive Air Showers and cosmic rays. In particular I invite you to read the review of KH Kampert and AA Watson, *Eur. Phys. J. H* 37, 359–412 (2012), which I had the honour to proof-read before publication.

Finally, the foundation of all what I know about EAS and detectors has been taught to me by Carlo Castagnoli and Gianni Navarra, now gone, but always alive in me.



**Thanks for your attention!**

**I hope that you won't think like Enrico Fermi did once:**

***“Before I came here I was confused about this subject.  
Having listened to your lecture I am still confused.  
But on a higher level.”***